

PRELIMINARY MAP

# "MOUNTAIN SHADOWS RESORT - CONDOMINIUM HOTEL"

A CONDOMINIUM UPON LOT 131 OF "MOUNTAIN SHADOW RESORT UNIT 2 - AMENDED VII" AS RECORDED IN BOOK 1232 OF MAPS, PAGE 27, M.C.R. AND SITUATED IN THE SOUTHEAST QUARTER OF SECTION 8, TOWNSHIP 2 NORTH, RANGE 4 EAST, OF THE GILA AND SALT RIVER BASE AND MERIDIAN, MARICOPA COUNTY, ARIZONA



NO.	REVISION	DATE

**Coe & Van Loo Consultants, Inc.**

**PRELIMINARY MAP**

**MOUNTAIN SHADOWS RESORT - CONDOMINIUM HOTEL**  
PARADISE VALLEY, ARIZONA

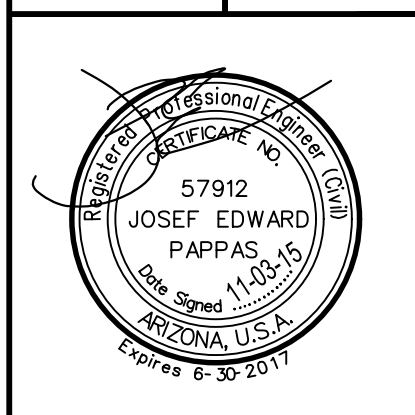

1 SHEET OF 14

CVL Contact: J. PAPPAS  
CVL Project #: 01-0245801  
CVL File #:

**DEDICATION**

STATE OF ARIZONA )  
 ) SS  
COUNTY OF MARICOPA )

KNOW ALL MEN BY THESE PRESENTS:

THAT MS CONDO HOTEL OWNER, LLC, A DELAWARE LIMITED LIABILITY COMPANY, AS OWNER, HAS SUBDIVIDED UNDER THE NAME OF "MOUNTAIN SHADOWS RESORT - CONDOMINIUM HOTEL" A CONDOMINIUM UPON LOT 131 OF "MOUNTAIN SHADOW RESORT UNIT 2 - AMENDED VII" AS RECORDED IN BOOK 1232 OF MAPS, PAGE 27, M.C.R. AND SITUATED IN THE SOUTHEAST QUARTER OF SECTION 8, TOWNSHIP 2 NORTH, RANGE 4 EAST, OF THE GILA AND SALT RIVER BASE AND MERIDIAN, MARICOPA COUNTY, ARIZONA, AS SHOWN PLATTED HEREON AND HEREBY PUBLISHES THIS FINAL PLAT AND DECLARES THAT THIS PLAT SETS FORTH THE LOCATION AND GIVES THE DIMENSIONS OF THE BOUNDARIES OF THE CONDOMINIUM UNITS, AND THAT EACH UNIT SHALL BE KNOWN BY THE NUMBER OR LETTER GIVEN EACH RESPECTIVELY ON SAID PLAT.

IN WITNESS WHEREOF:

MS CONDO HOTEL OWNER, LLC, A DELAWARE LIMITED LIABILITY COMPANY, AS OWNER OF THE LAND DESCRIBED HEREIN, HAS CAUSED ITS NAME TO BE AFFIXED AND THE SAME TO BE ATTESTED BY THE SIGNATURE OF THE UNDERSIGNED DULY AUTHORIZED OFFICER.

MS CONDO HOTEL OWNER, LLC, A DELAWARE LIMITED LIABILITY COMPANY

BY: \_\_\_\_\_ DATE: \_\_\_\_\_  
KRISTOPHER HARMAN  
ITS: AUTHORIZED SIGNATORY

**ACKNOWLEDGEMENT**

STATE OF ARIZONA )  
 ) SS  
COUNTY OF MARICOPA )

ON THIS \_\_\_ DAY OF \_\_\_\_\_, 2015, BEFORE ME, THE UNDERSIGNED NOTARY PUBLIC IN AND FOR SAID STATE, PERSONALLY APPEARED

\_\_\_\_\_, PERSONALLY KNOWN TO ME (OR PROVED TO ME ON THE BASIS OF SATISFACTORY EVIDENCE) TO BE THE PERSON WHOSE NAME IS SUBSCRIBED TO THE WITHIN INSTRUMENT AND ACKNOWLEDGED TO ME THAT HE/SHE EXECUTED THE SAME IN HIS/HER AUTHORIZED CAPACITY, AND THAT BY HIS/HER SIGNATURE ON THE INSTRUMENT THE PERSON, OR THE ENTITY UPON BEHALF OF WHICH THE PERSON ACTED, EXECUTED THE INSTRUMENT.

WITNESS MY HAND AND OFFICIAL SEAL

\_\_\_\_\_  
NOTARY PUBLIC

**APPROVAL**

APPROVED BY THE TOWN COUNCIL OF THE TOWN OF PARADISE VALLEY, ARIZONA THIS \_\_\_ DAY OF \_\_\_\_\_, 2015.

BY: \_\_\_\_\_  
MAYOR

ATTEST: \_\_\_\_\_  
TOWN CLERK  
\_\_\_\_\_  
TOWN ENGINEER  
\_\_\_\_\_  
PLANNING DIRECTOR

**CERTIFICATION**

I, LARRY E. SULLIVAN, HEREBY CERTIFY THAT I AM A REGISTERED LAND SURVEYOR IN THE STATE OF ARIZONA, THAT THIS MAP, CONSISTING OF FOURTEEN (14) SHEETS, CORRECTLY REPRESENTS A BOUNDARY SURVEY MADE UNDER MY SUPERVISION DURING THE MONTH OF JUNE, 2015, THAT THE SURVEY IS TRUE AND COMPLETE AS SHOWN, THAT ALL MONUMENTS SHOWN ACTUALLY EXIST OR WILL BE SET AS SHOWN, THAT THEIR POSITIONS ARE CORRECTLY SHOWN AND THAT SAID MONUMENTS ARE SUFFICIENT TO ENABLE THE SURVEY TO BE RETRACED.

BY: \_\_\_\_\_  
LARRY E. SULLIVAN  
REGISTRATION NUMBER 22782  
4550 N. 12TH STREET  
PHOENIX, ARIZONA 85014  
(602)-264-6831  
CVLSURVEY@CVLCI.COM

**NOTES**

- THE BOUNDARIES OF EACH UNIT ARE AS FOLLOWS:
  - THE VERTICAL BOUNDARIES ARE THE INTERIOR FINISHED SURFACES OF THE PERMIETER WALLS OF THE UNIT;
  - THE LOWER HORIZONTAL BOUNDARY IS THE TOP SURFACE OF THE FLOOR SLAB BENEATH THE UNIT; AND
  - THE UPPER AND LOWER HORIZONTAL BOUNDARIES OF EACH UNIT SHALL BE FROM THE UNFINISHED FLOOR OR EACH UNIT TO THE UNFINISHED CEILING OF EACH UNIT.
- TIES SHOWN ARE TO OUTSIDE FACE OF BUILDINGS (GROUND LEVEL).
- EASEMENTS FOR THE PRIVATE DRIVE, AND PUBLIC AND PRIVATE UTILITIES WILL BE PROVIDED WITH A MAP OF DEDICATION TO BE PROCESSED WITH THE FINAL MAP FOR "MOUNTAIN SHADOWS RESORT - CONDOMINIUM HOTEL".
- NO POWER POLES EXIST ON-SITE.
- BUILDING HEIGHT WILL COMPLY WITH THE MOUNTAIN SHADOWS RESORT SPECIAL USE PERMIT REQUIREMENTS.

**OWNER / DEVELOPER**

MS CONDO HOTEL OWNER LLC  
1900 NORTH AKARD STREET  
DALLAS, TEXAS 75201  
PHONE: (480) 951-1100  
CONTACT: KRISTOPHER HARMAN

**ARCHITECT**

ALLEN + PHILP  
7154 EAST STETSON DRIVE, FOURTH FLOOR  
SCOTTSDALE, ARIZONA 85251  
PHONE: (480) 990-2800  
CONTACT: MATT KOSEDNAR

**ENGINEER**

COE & VAN LOO CONSULTANTS, INC.  
4550 NORTH 12TH STREET  
PHOENIX, ARIZONA 85014  
PHONE: (602) 264-6831  
FAX: (602) 264-0928  
CONTACT: JOSEF PAPPAS, P.E.

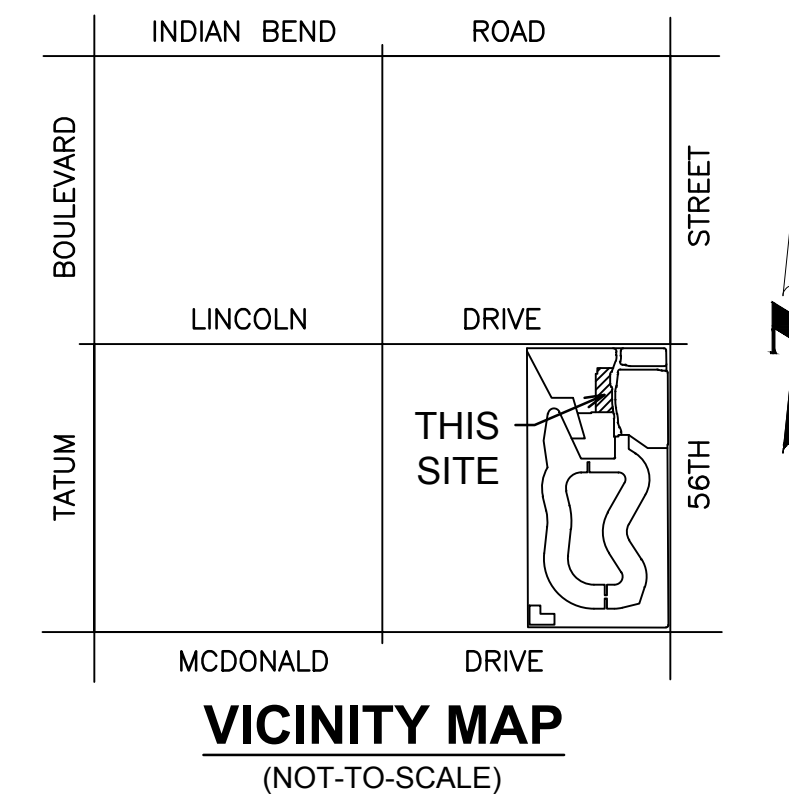

**DRAINAGE EASEMENT RESTRICTIONS**

PURSUANT TO A.R.S. 9-463.01 (C), AND SECTION 6-4 (E)(J), 8-7-1 ET. SEQ. AND 6-3-8 OF THE CODE OF ORDINANCES OF THE TOWN OF PARADISE VALLEY, DRAINAGE EASEMENTS ARE FOR THE PURPOSE OF ALLOWING STORM, FLOOD AND OTHER WATERS TO PASS OVER, UNDER, OR THROUGH THE LAND SET ASIDE FOR SUCH EASEMENTS, AND NOTHING WHICH MAY, TO ANY DEGREE, IMPEDE OR OBSTRUCT THE FLOW OF SUCH WATER, SHALL BE CONSTRUCTED, PLACED, PLANTED OR ALLOWED TO GROW ON OR IN SUCH EASEMENTS. THE MAINTENANCE AND CLEARING OF THESE DRAINAGE EASEMENTS SHALL BE THE SOLE RESPONSIBILITY AND DUTY OF THE OWNER OF THE PROPERTY ON WHICH SAID EASEMENTS ARE PLATTED. HOWEVER, IF THE TOWN DEEMS IT TO BE IN THE BEST INTERESTS OF THE HEALTH, SAFETY, OR WELFARE OF THE TOWN OF PARADISE VALLEY, THE TOWN OF PARADISE VALLEY MAY CONSTRUCT AND/OR MAINTAIN DRAINAGE FACILITIES ON OR UNDER SUCH EASEMENTS. AGENTS AND EMPLOYEES OF THE TOWN OF PARADISE VALLEY SHALL HAVE FREE ACCESS TO AND FROM ALL PORTIONS OF SUCH EASEMENTS AT ALL TIMES.

**UTILITY PROVIDERS**

SEWER	CITY OF PHOENIX
WATER	EPCOR WATER
TELEPHONE	CENTURYLINK
CABLE	COX COMMUNICATIONS
GAS	SOUTHWEST GAS
ELECTRIC	ARIZONA PUBLIC SERVICE

**100 YEAR ASSURED WATER SUPPLY**

THE AREA PLATTED HEREON LIES WITHIN THE DOMESTIC WATER SERVICE AREA OF EPCOR WATER ARIZONA INC. - PARADISE VALLEY WHICH IS DESIGNATED AS HAVING AN ASSURED WATER SUPPLY PURSUANT TO SECTION 45-576 ARIZONA REVISED STATUTES AS PER ARIZONA DEPARTMENT OF WATER RESOURCES CERTIFICATE NUMBER 27-700839.0000 DATED NOVEMBER 12, 2015.

**SITE DATA**

APN	169-30-102
EXISTING ZONING	S.U.P. - RESORT
TOTAL UNITS	44

**SHEET INDEX**

1	COVER SHEET, DEDICATION, NOTES
2	BOUNDARY MAP
3	FIRST LEVEL PLAN
4	SECOND LEVEL PLAN
5	THIRD LEVEL PLAN
6	PARKING GARAGE
7 - 13	UNIT PLANS
14	VERTICAL SCHEMATIC

**BASIS OF BEARING**

THE BASIS OF BEARING FOR THIS SURVEY IS NORTH 00°16'59" WEST ALONG THE WEST LINE OF THE SOUTHWEST QUARTER OF SECTION 9, TOWNSHIP 2 NORTH, RANGE 4 EAST OF THE GILA AND SALT RIVER MERIDIAN, MARICOPA COUNTY, ARIZONA.

**LEGEND**

---▲---	INDICATES SECTION CORNER - FOUND BRASS CAP (UNLESS OTHERWISE NOTED)
---●---	INDICATES FOUND BRASS CAP PER ADJOINING RECORDED SUBDIVISION PER M.A.G. STD. DET. 120, TYPE "B" (UNLESS OTHERWISE NOTED)
---	INDICATES INTERIOR BOUNDARY
---	INDICATES EXTERIOR FACE / COMMON WALL
---	INDICATES FLOOR LIMITS
U.E.	INDICATES UTILITY EASEMENT PER BOOK 1232 OF MAPS, PAGE 27, M.C.R.
C1	INDICATES CURVE NUMBER
P11	INDICATES DESIGNATED PARKING SPACE NUMBER
U11	INDICATES DESIGNATED STORAGE ROOM NUMBER

**BENCHMARK**

WEST 1/4 CORNER OF SECTION 9, TOWNSHIP 2 NORTH, RANGE 4 EAST TOWN OF PARADISE VALLEY BRASS CAP IN HANDHOLE LOCATED AT THE INTERSECTION OF 56TH STREET & LINCOLN  
ELEVATION = 1363.42 (NAVD 88)  
MCDOT GDACS NO. 24534-1  
N: 20751.98, E: 86642.68

GROSS AREA = 1.337 ACRES

PRELIMINARY MAP

# "MOUNTAIN SHADOWS RESORT - CONDOMINIUM HOTEL"

A CONDOMINIUM UPON LOT 131 OF "MOUNTAIN SHADOW RESORT UNIT 2 - AMENDED VII" AS RECORDED IN BOOK 1232 OF MAPS, PAGE 27, M.C.R. AND SITUATED IN THE SOUTHEAST QUARTER OF SECTION 8, TOWNSHIP 2 NORTH, RANGE 4 EAST, OF THE GILA AND SALT RIVER BASE AND MERIDIAN, MARICOPA COUNTY, ARIZONA

## BOUNDARY MAP

CURVE TABLE						
NO.	ARC	RADIUS	DELTA	TANGENT	CHORD	CHORD-BEARING
C1	31.93	30.00	060°58'28"	17.66	30.44	S30°29'14"W
C2	29.16	50.00	033°25'04"	15.01	28.75	S16°42'32"E
C3	28.92	50.00	033°08'06"	14.87	28.51	N16°51'02"W
C4	78.78	515.00	008°45'52"	39.47	78.70	S04°39'55"E
C5	25.62	20.00	073°23'42"	14.91	23.90	N27°39'00"E
C6	52.15	235.00	012°42'54"	26.18	52.04	N06°04'28"E
C7	53.24	34.00	089°43'01"	33.83	47.96	N45°08'29"W

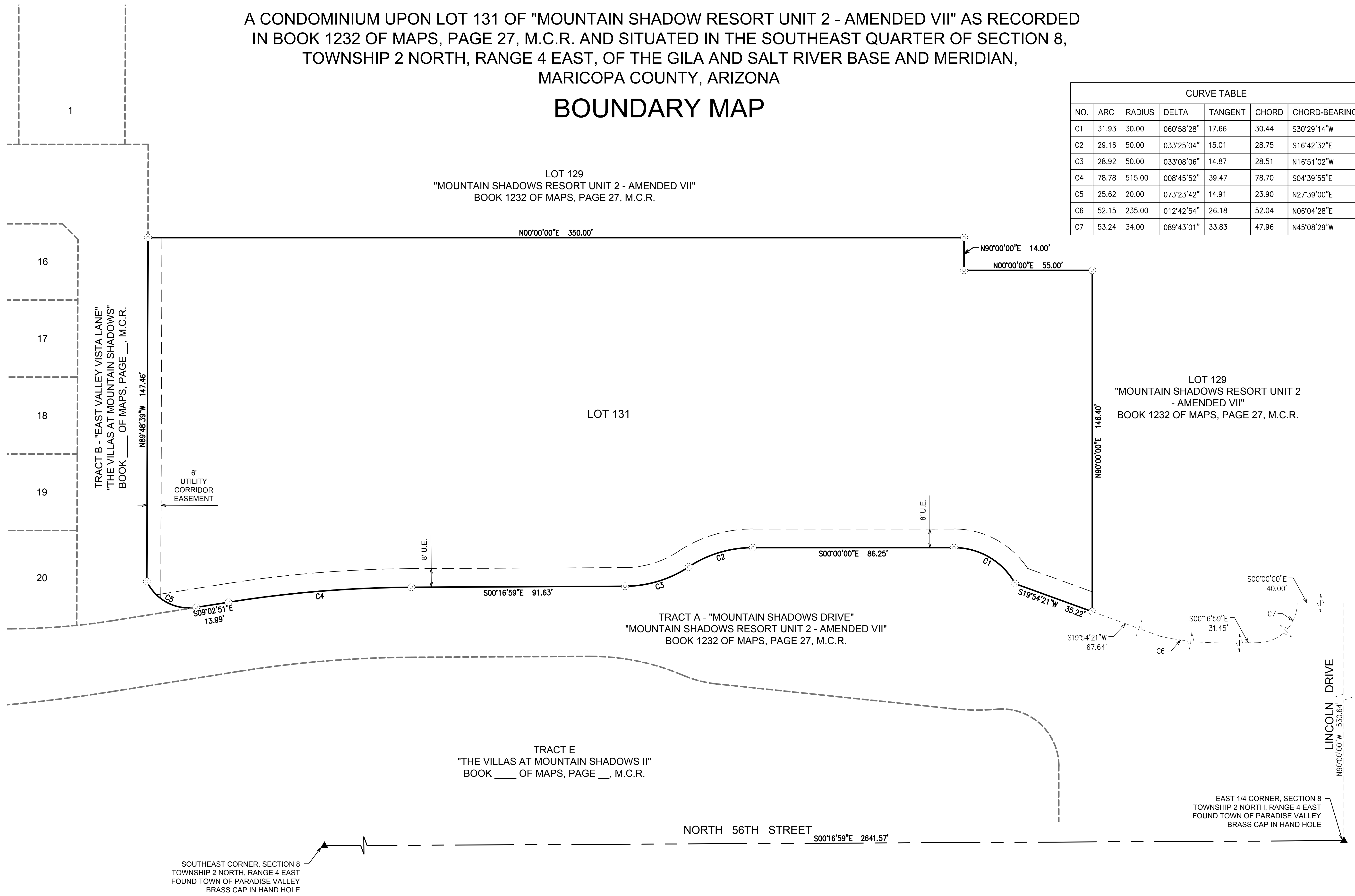

NO.	REVISION	DATE

PRELIMINARY MAP

MOUNTAIN SHADOWS RESORT - CONDOMINIUM HOTEL  
PARADISE VALLEY, ARIZONA

Coe & Van Loo Consultants, Inc.

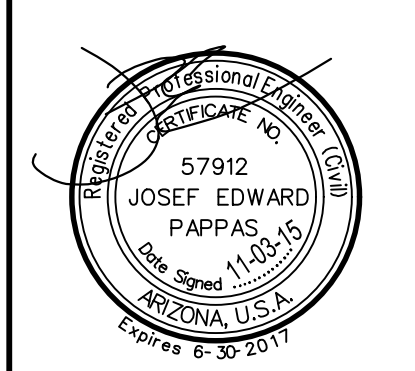

02 SHEET OF 14

CVL Contact: J. PAPPAS  
CVL Project #: 01-0245801  
CVL File #:

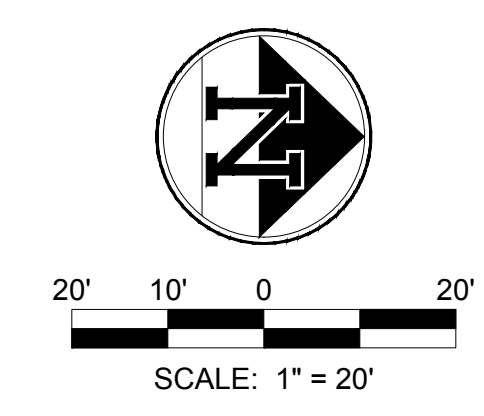

Printed By: Joep Print Date: November 23, 2015 File Name: N:\010245801\CADD\WEST\Condo\Preliminary\PS CO PRE.MAP.02.dwg

**CVL CONSULTANTS**  
4560 North 12th Street  
Phoenix, Arizona 85014  
602-264-6831  
www.cvlci.com

PRELIMINARY MAP

# "MOUNTAIN SHADOWS RESORT - CONDOMINIUM HOTEL"

A CONDOMINIUM UPON LOT 131 OF "MOUNTAIN SHADOW RESORT UNIT 2 - AMENDED VII" AS RECORDED IN BOOK 1232 OF MAPS, PAGE 27, M.C.R. AND SITUATED IN THE SOUTHEAST QUARTER OF SECTION 8, TOWNSHIP 2 NORTH, RANGE 4 EAST, OF THE GILA AND SALT RIVER BASE AND MERIDIAN, MARICOPA COUNTY, ARIZONA

## FIRST LEVEL PLAN

CURVE TABLE						
NO.	ARC	RADIUS	DELTA	TANGENT	CHORD	CHORD-BEARING
C1	31.93	30.00	060°58'28"	17.66	30.44	S30°29'14"W
C2	29.16	50.00	033°25'04"	15.01	28.75	S16°42'32"E
C3	28.92	50.00	033°08'06"	14.87	28.51	N16°51'02"W
C4	78.78	515.00	008°45'52"	39.47	78.70	S04°39'55"E
C5	25.62	20.00	073°23'42"	14.91	23.90	N27°39'00"E
C6	52.15	235.00	012°42'54"	26.18	52.04	N06°04'28"E
C7	53.24	34.00	089°43'01"	33.83	47.96	N45°08'29"W

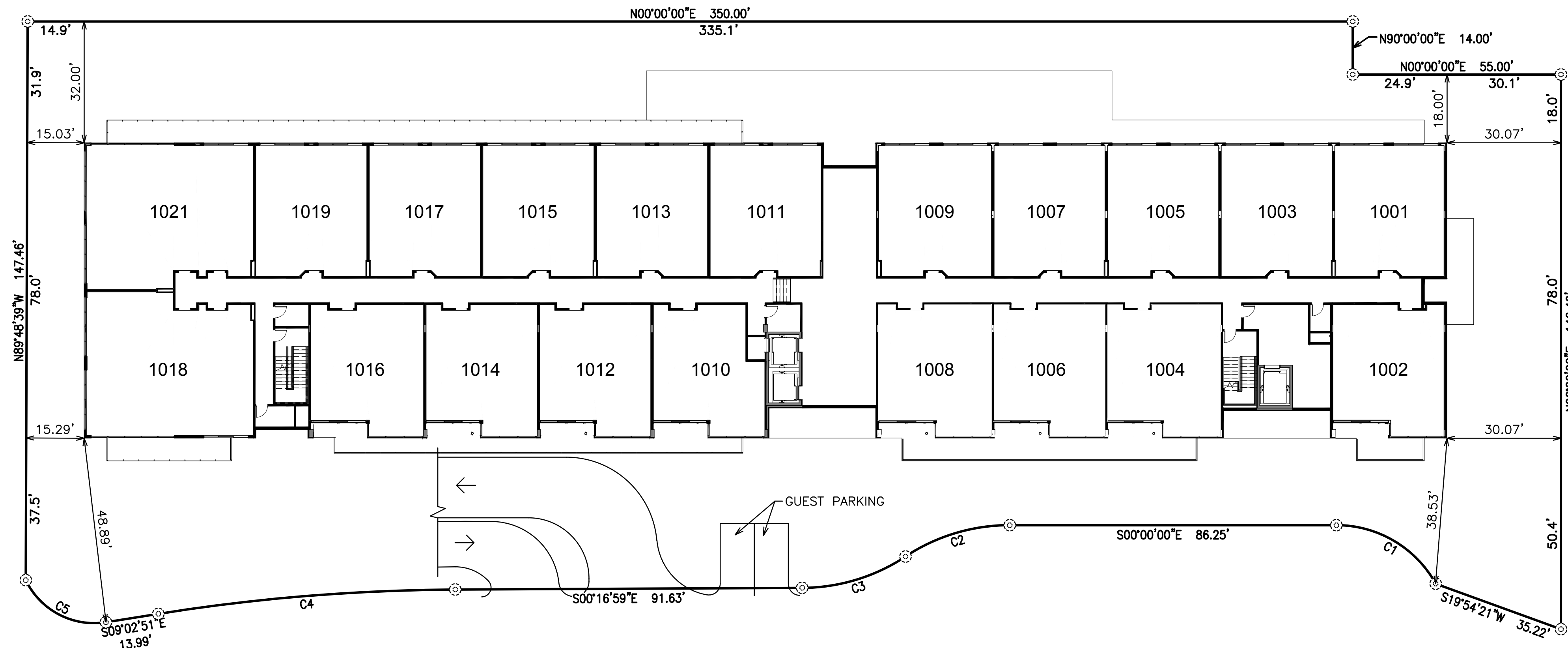

DATE

REVISION

NO.

**Coe & Van Loo Consultants, Inc.**

PRELIMINARY MAP

MOUNTAIN SHADOWS RESORT - CONDOMINIUM HOTEL  
PARADISE VALLEY, ARIZONA

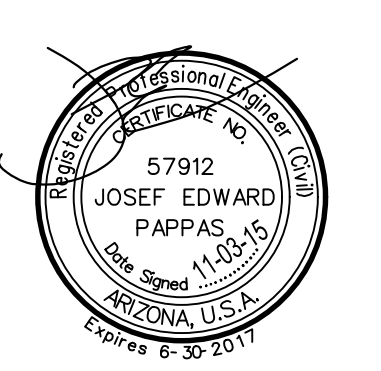

3 SHEET OF 14

CVL Contact: J. PAPPAS  
CVL Project #: 01-0245801  
CVL File #:

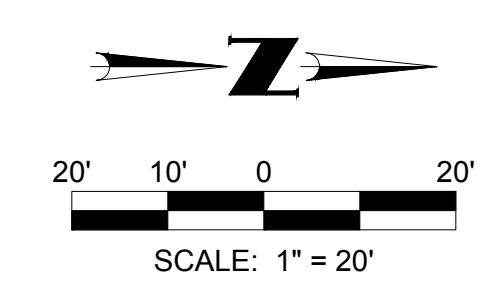

PRELIMINARY MAP

# "MOUNTAIN SHADOWS RESORT - CONDOMINIUM HOTEL"

A CONDOMINIUM UPON LOT 131 OF "MOUNTAIN SHADOW RESORT UNIT 2 - AMENDED VII" AS RECORDED IN BOOK 1232 OF MAPS, PAGE 27, M.C.R. AND SITUATED IN THE SOUTHEAST QUARTER OF SECTION 8, TOWNSHIP 2 NORTH, RANGE 4 EAST, OF THE GILA AND SALT RIVER BASE AND MERIDIAN, MARICOPA COUNTY, ARIZONA

## SECOND LEVEL PLAN

CURVE TABLE						
NO.	ARC	RADIUS	DELTA	TANGENT	CHORD	CHORD-BEARING
C1	31.93	30.00	060°58'28"	17.66	30.44	S30°29'14"W
C2	29.16	50.00	033°25'04"	15.01	28.75	S16°42'32"E
C3	28.92	50.00	033°08'06"	14.87	28.51	N16°51'02"W
C4	78.78	515.00	008°45'52"	39.47	78.70	S04°39'55"E
C5	25.62	20.00	073°23'42"	14.91	23.90	N27°39'00"E
C6	52.15	235.00	012°42'54"	26.18	52.04	N06°04'28"E
C7	53.24	34.00	089°43'01"	33.83	47.96	N45°08'29"W

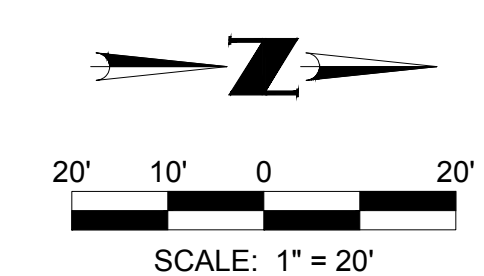
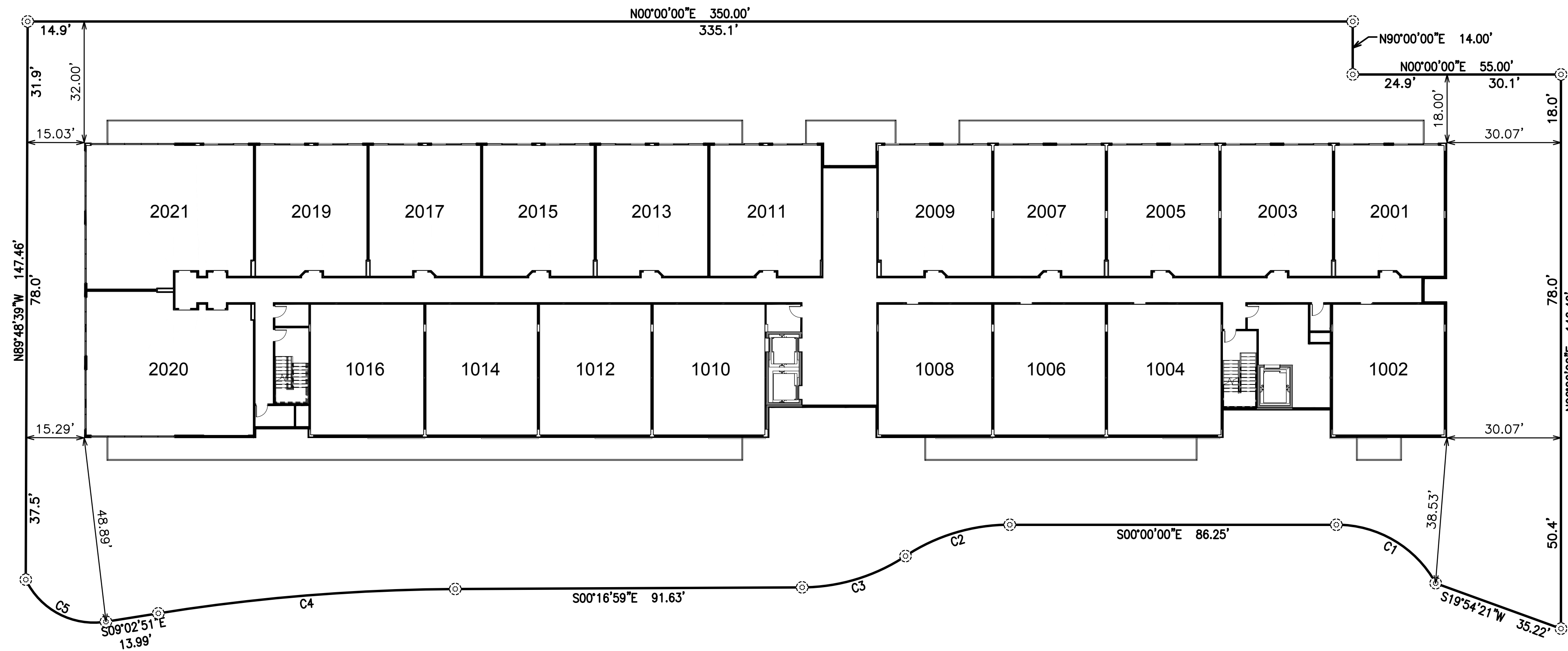

NO.	REVISION	DATE

PRELIMINARY MAP

MOUNTAIN SHADOWS RESORT - CONDOMINIUM HOTEL  
PARADISE VALLEY, ARIZONA

4 SHEET OF 14

CVL Contact: J. PAPPAS  
CVL Project #: 01-0245801  
CVL File #:

**CVL CONSULTANTS**

4560 North 12th Street  
Phoenix, Arizona 85014  
602-264-6831  
www.cvlci.com

PRELIMINARY MAP

# "MOUNTAIN SHADOWS RESORT - CONDOMINIUM HOTEL"

A CONDOMINIUM UPON LOT 131 OF "MOUNTAIN SHADOW RESORT UNIT 2 - AMENDED VII" AS RECORDED  
IN BOOK 1232 OF MAPS, PAGE 27, M.C.R. AND SITUATED IN THE SOUTHEAST QUARTER OF SECTION 8,  
TOWNSHIP 2 NORTH, RANGE 4 EAST, OF THE GILA AND SALT RIVER BASE AND MERIDIAN,  
MARICOPA COUNTY, ARIZONA

## THIRD LEVEL PLAN

CURVE TABLE						
NO.	ARC	RADIUS	DELTA	TANGENT	CHORD	CHORD-BEARING
C1	31.93	30.00	060°58'28"	17.66	30.44	S30°29'14"W
C2	29.16	50.00	033°25'04"	15.01	28.75	S16°42'32"E
C3	28.92	50.00	033°08'06"	14.87	28.51	N16°51'02"W
C4	78.78	515.00	008°45'52"	39.47	78.70	S04°39'55"E
C5	25.62	20.00	073°23'42"	14.91	23.90	N27°39'00"E
C6	52.15	235.00	012°42'54"	26.18	52.04	N06°04'28"E
C7	53.24	34.00	089°43'01"	33.83	47.96	N45°08'29"W

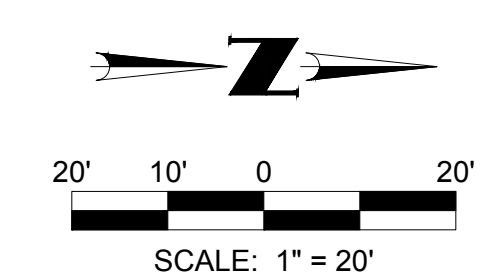
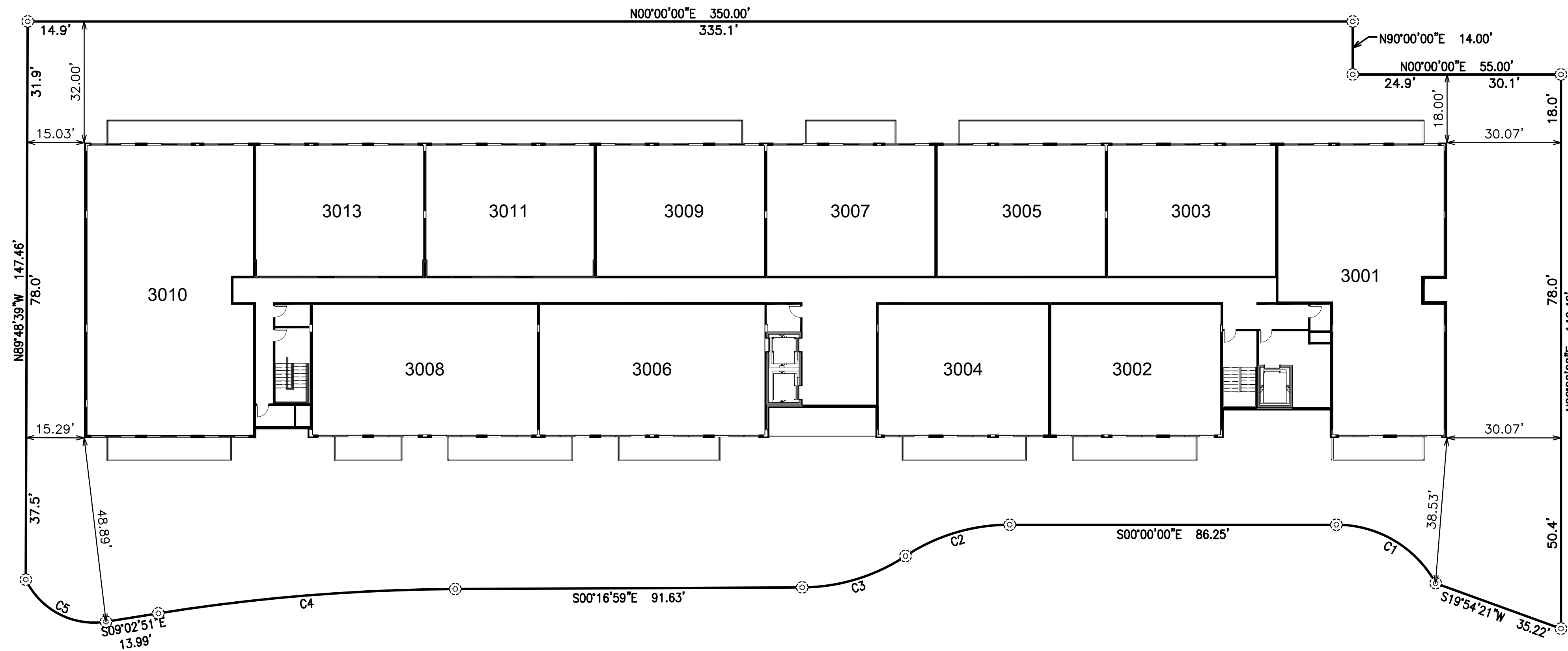

NO.	REVISION	DATE

PRELIMINARY MAP  
MOUNTAIN SHADOWS RESORT - CONDOMINIUM HOTEL  
PARADISE VALLEY, ARIZONA

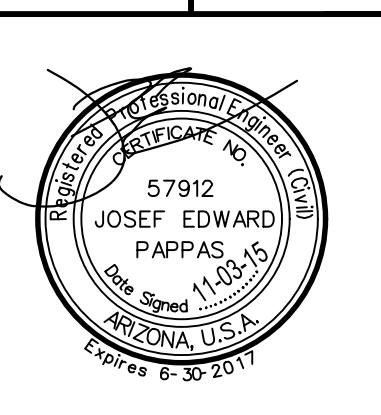

5 SHEET OF 14  
CVL Contact: J. PAPPAS  
CVL Project #: 01-0245801  
CVL File #:

**CVL CONSULTANTS**  
4560 North 12th Street  
Phoenix, Arizona 85014  
602-264-6831  
www.cvlci.com

# PRELIMINARY MAP "MOUNTAIN SHADOWS RESORT - CONDOMINIUM HOTEL"

A CONDOMINIUM UPON LOT 131 OF "MOUNTAIN SHADOW RESORT UNIT 2 - AMENDED VII" AS RECORDED IN BOOK 1232 OF MAPS, PAGE 27, M.C.R. AND SITUATED IN THE SOUTHEAST QUARTER OF SECTION 8, TOWNSHIP 2 NORTH, RANGE 4 EAST, OF THE GILA AND SALT RIVER BASE AND MERIDIAN, MARICOPA COUNTY, ARIZONA

## PARKING GARAGE

CURVE TABLE						
NO.	ARC	RADIUS	DELTA	TANGENT	CHORD	CHORD-BEARING
C1	31.93	30.00	060°58'28"	17.66	30.44	S30°29'14"W
C2	29.16	50.00	033°25'04"	15.01	28.75	S16°42'32"E
C3	28.92	50.00	033°08'06"	14.87	28.51	N16°51'02"W
C4	78.78	515.00	008°45'52"	39.47	78.70	S04°39'55"E
C5	25.62	20.00	073°23'42"	14.91	23.90	N27°39'00"E
C6	52.15	235.00	012°42'54"	26.18	52.04	N06°04'28"E
C7	53.24	34.00	089°43'01"	33.83	47.96	N45°08'29"W

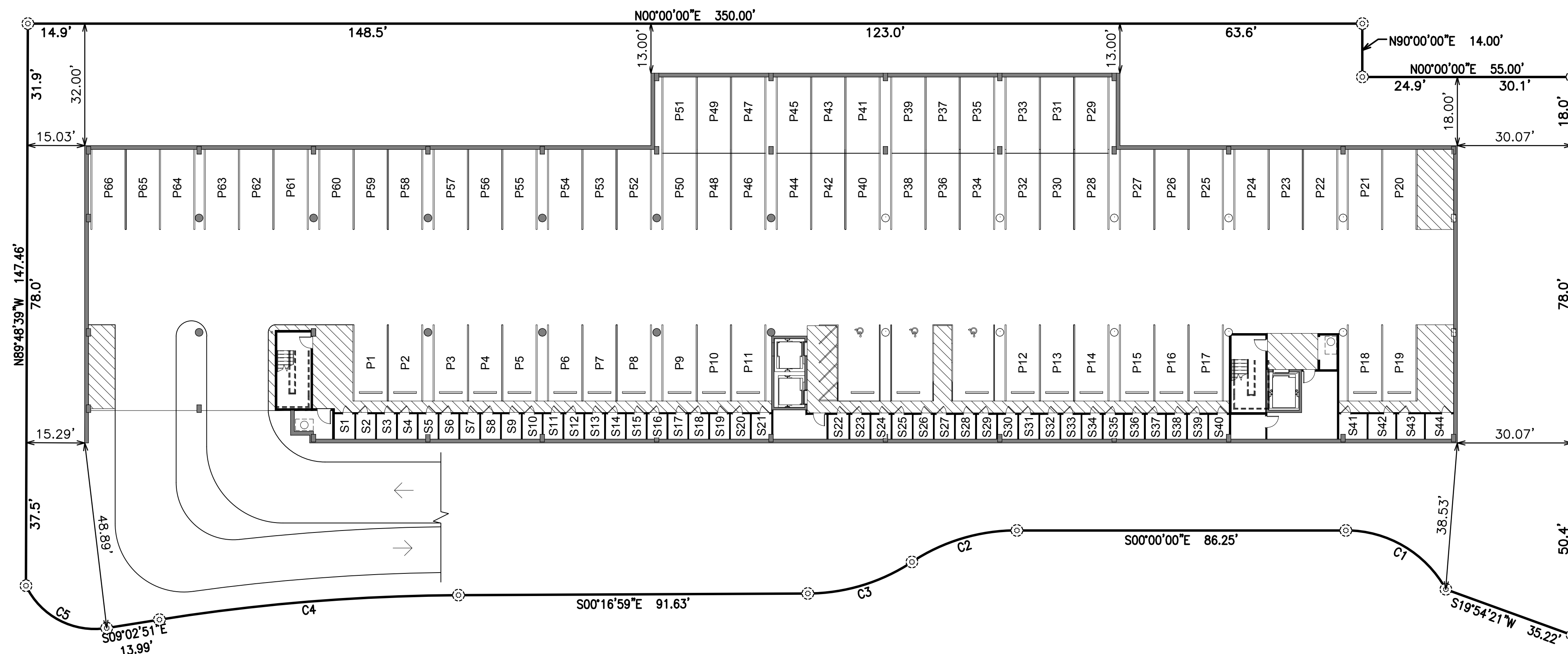

UNIT NUMBER	STORAGE NUMBER	PARKING SPACE NUMBER
1001		
1002		
1003		
1004		
1005		
1006		
1007		
1008		
1009		
1010		
1011		
1012		
1013		
1014		
1015		
1016		
1017		
1018		
1019		
1021		
2001		
2003		
2005		
2007		
2009		
2011		
2013		
2015		
2017		
2019		
2020		
2021		
3001		
3002		
3003		
3004		
3005		
3006		
3007		
3008		
3009		
3010		
3011		
3013		

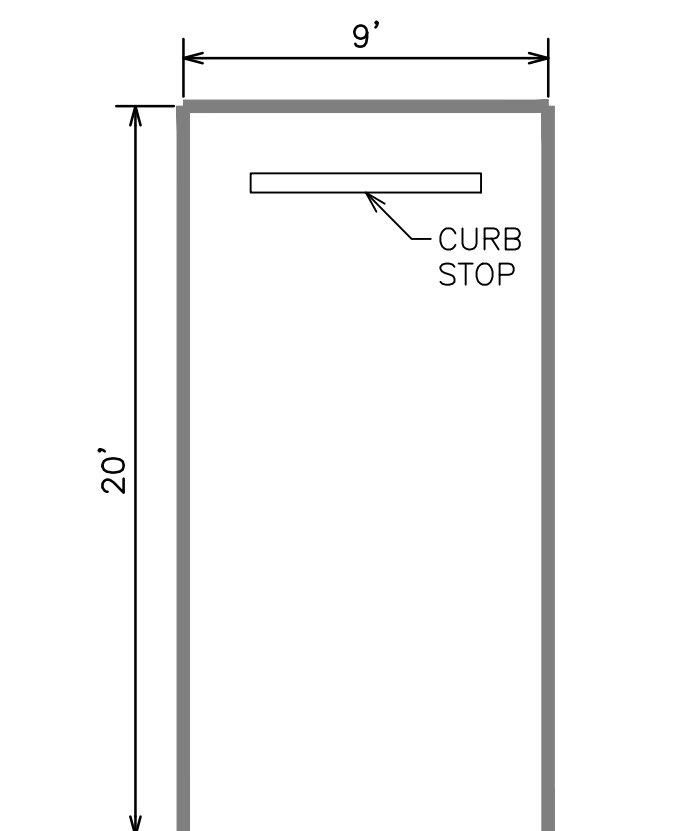

TYPICAL PARKING SPACE  
N.T.S.

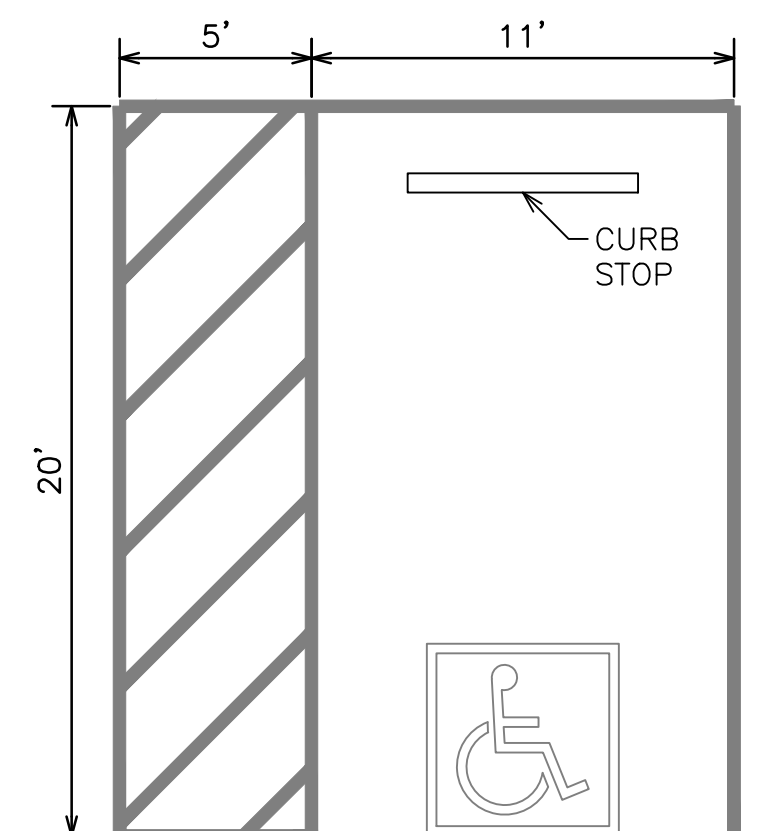

TYPICAL ADA PARKING SPACE  
N.T.S.

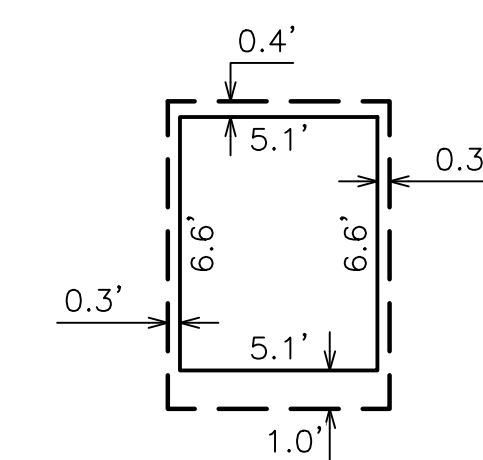

STORAGE ROOM DETAIL  
(FOR STORAGE ROOMS 1 - 40)  
SCALE: 1" = 5'

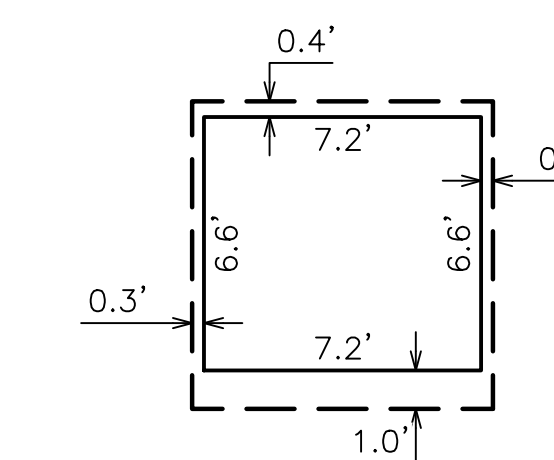

STORAGE ROOM DETAIL  
(FOR STORAGE ROOMS 41 - 44)  
SCALE: 1" = 5'

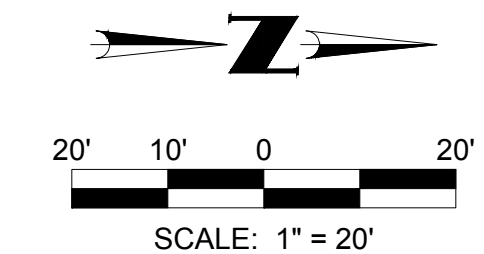

SCALE: 1" = 20'

NO.	REVISION	DATE

**PRELIMINARY MAP**

**MOUNTAIN SHADOWS RESORT - CONDOMINIUM HOTEL**  
PARADISE VALLEY, ARIZONA

**Coe & Van Loo Consultants, Inc.**

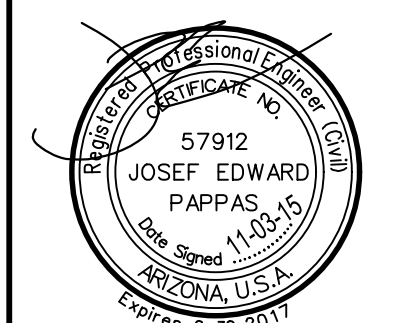

PRELIMINARY MAP

# "MOUNTAIN SHADOWS RESORT - CONDOMINIUM HOTEL"

A CONDOMINIUM UPON LOT 131 OF "MOUNTAIN SHADOW RESORT UNIT 2 - AMENDED VII" AS RECORDED IN BOOK 1232 OF MAPS, PAGE 27, M.C.R. AND SITUATED IN THE SOUTHEAST QUARTER OF SECTION 8, TOWNSHIP 2 NORTH, RANGE 4 EAST, OF THE GILA AND SALT RIVER BASE AND MERIDIAN, MARICOPA COUNTY, ARIZONA

## UNIT PLANS

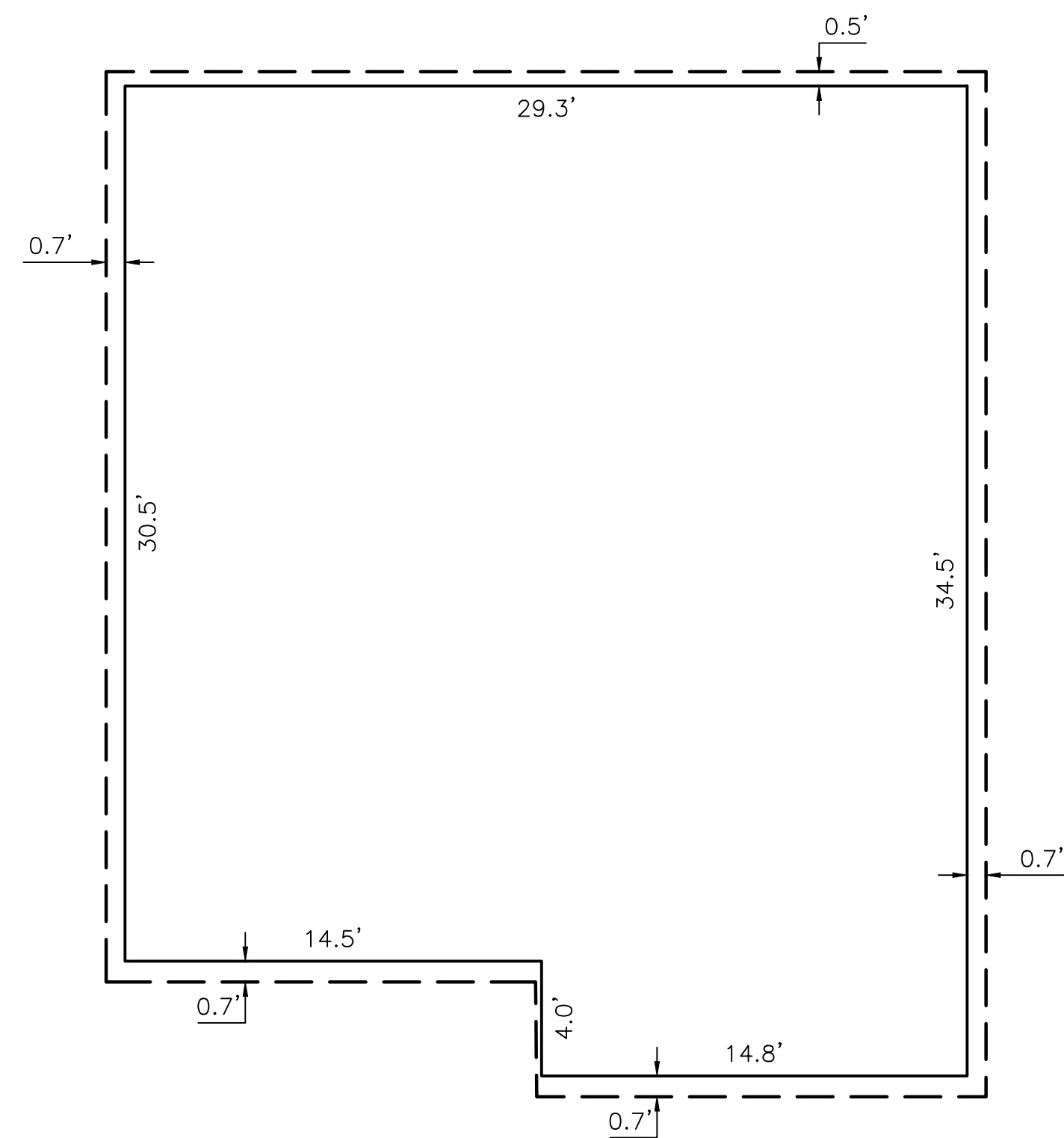

FIRST LEVEL PLAN

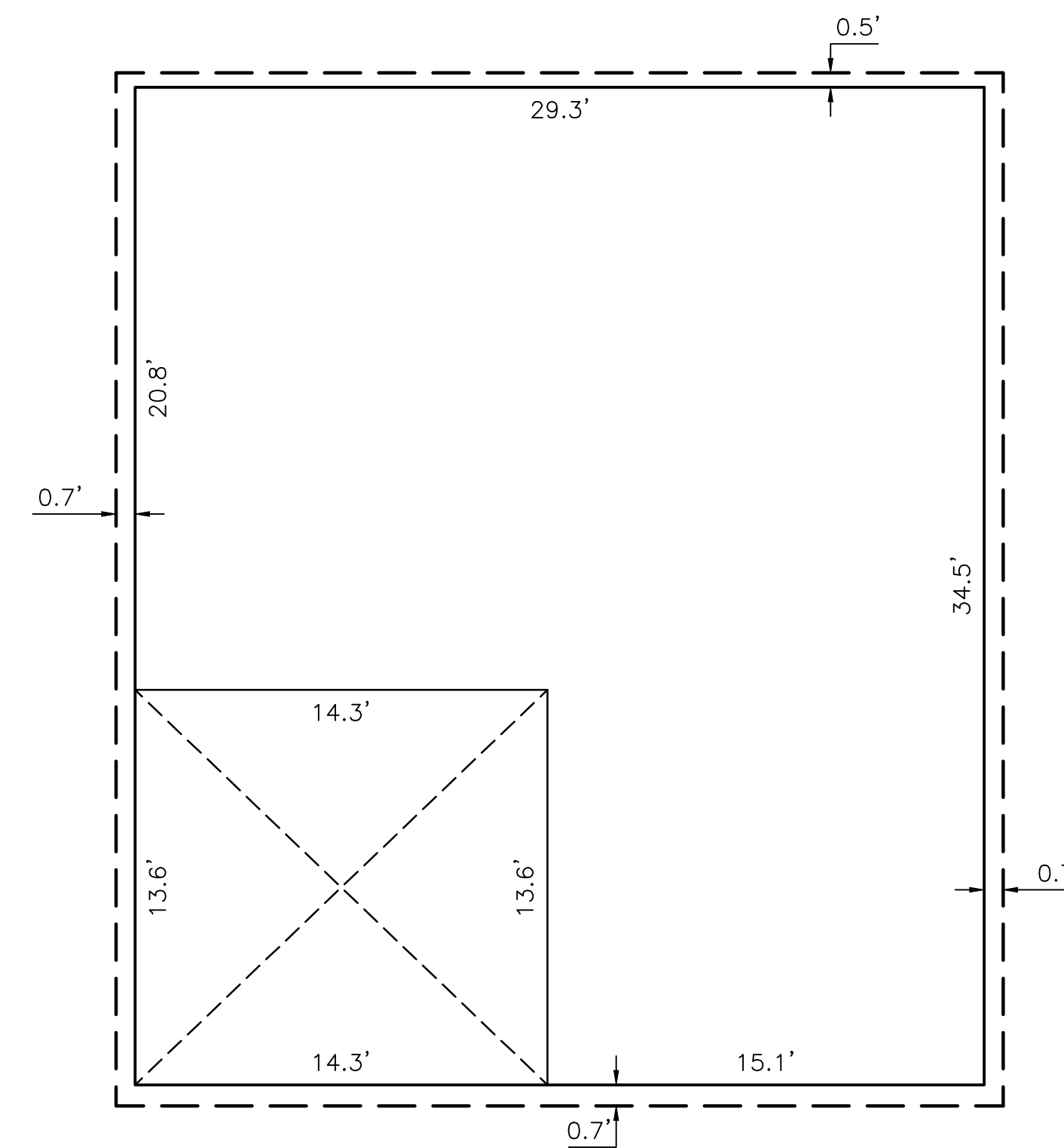

SECOND LEVEL PLAN

UNIT TYPE A		
UNIT NO.	LOWER UNIT BOUNDARY	UPPER UNIT BOUNDARY
1004		
1006		
1008		
1012		
1014		
1016		

**LEGEND**

- INDICATES INTERIOR BOUNDARY
- - - - INDICATES EXTERIOR FACE / COMMON WALL
- INDICATES FLOOR LIMITS

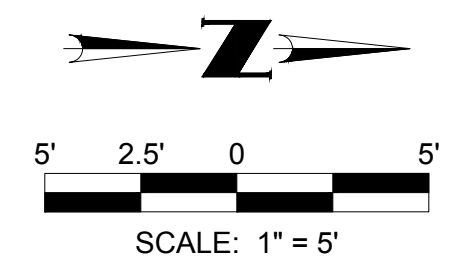

NO.	REVISION	DATE

PRELIMINARY MAP

MOUNTAIN SHADOWS RESORT - CONDOMINIUM HOTEL  
PARADISE VALLEY, ARIZONA

**Coe & Van Loo Consultants, Inc.**

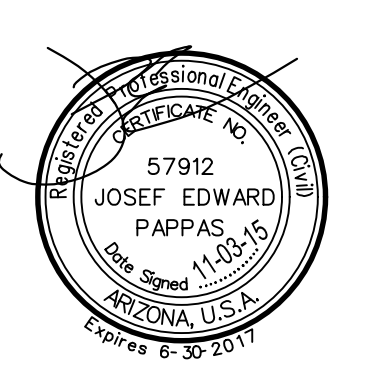

Printed By: Joep Print Date: November 23, 2015 Filename: N:\010245801\CADD\WEST\Condo\Preliminary\PS\_CO\_PRE\_MAP.07.dwg

PRELIMINARY MAP

# "MOUNTAIN SHADOWS RESORT - CONDOMINIUM HOTEL"

A CONDOMINIUM UPON LOT 131 OF "MOUNTAIN SHADOW RESORT UNIT 2 - AMENDED VII" AS RECORDED IN BOOK 1232 OF MAPS, PAGE 27, M.C.R. AND SITUATED IN THE SOUTHEAST QUARTER OF SECTION 8, TOWNSHIP 2 NORTH, RANGE 4 EAST, OF THE GILA AND SALT RIVER BASE AND MERIDIAN, MARICOPA COUNTY, ARIZONA

## UNIT PLANS

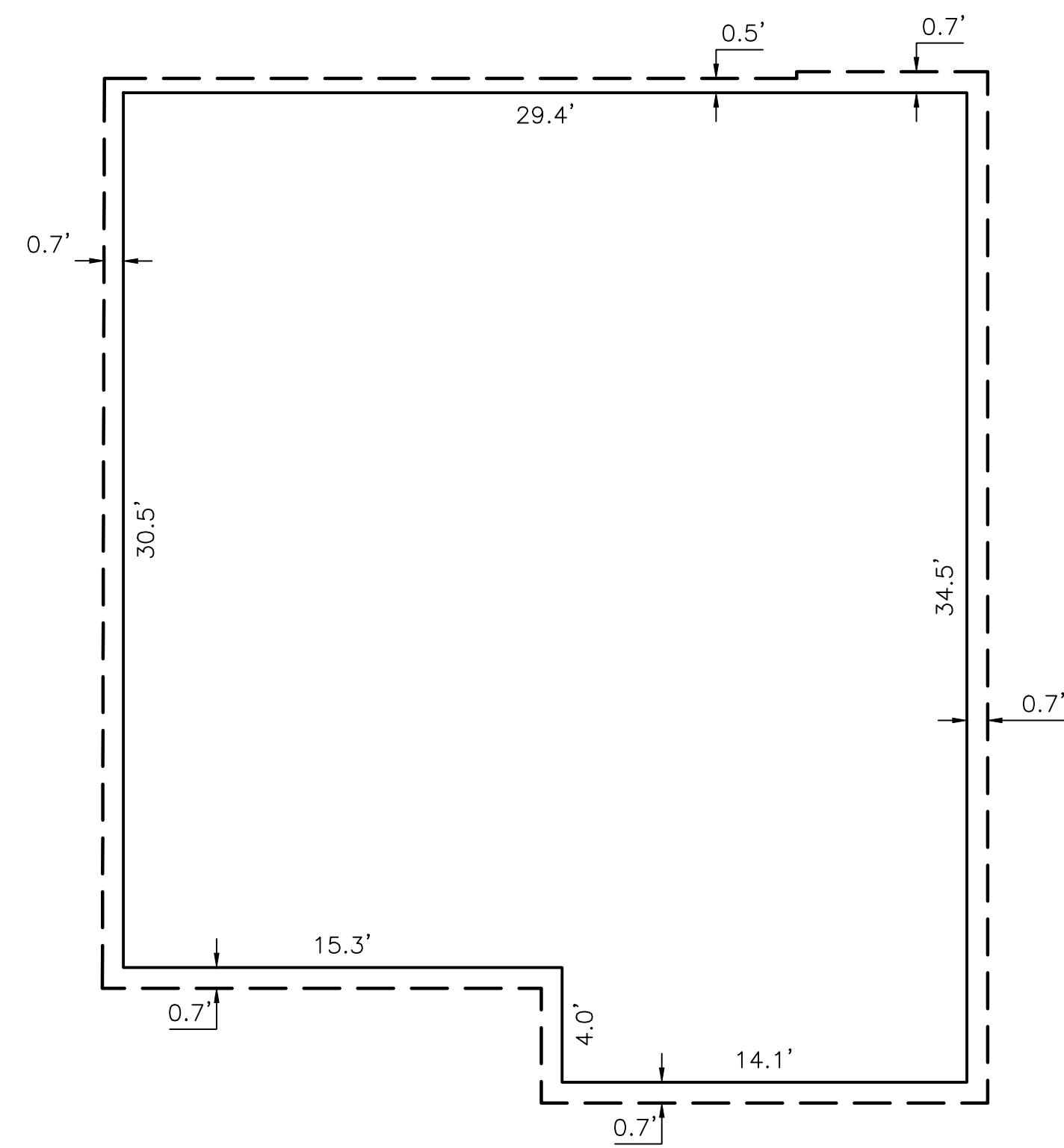

FIRST LEVEL PLAN

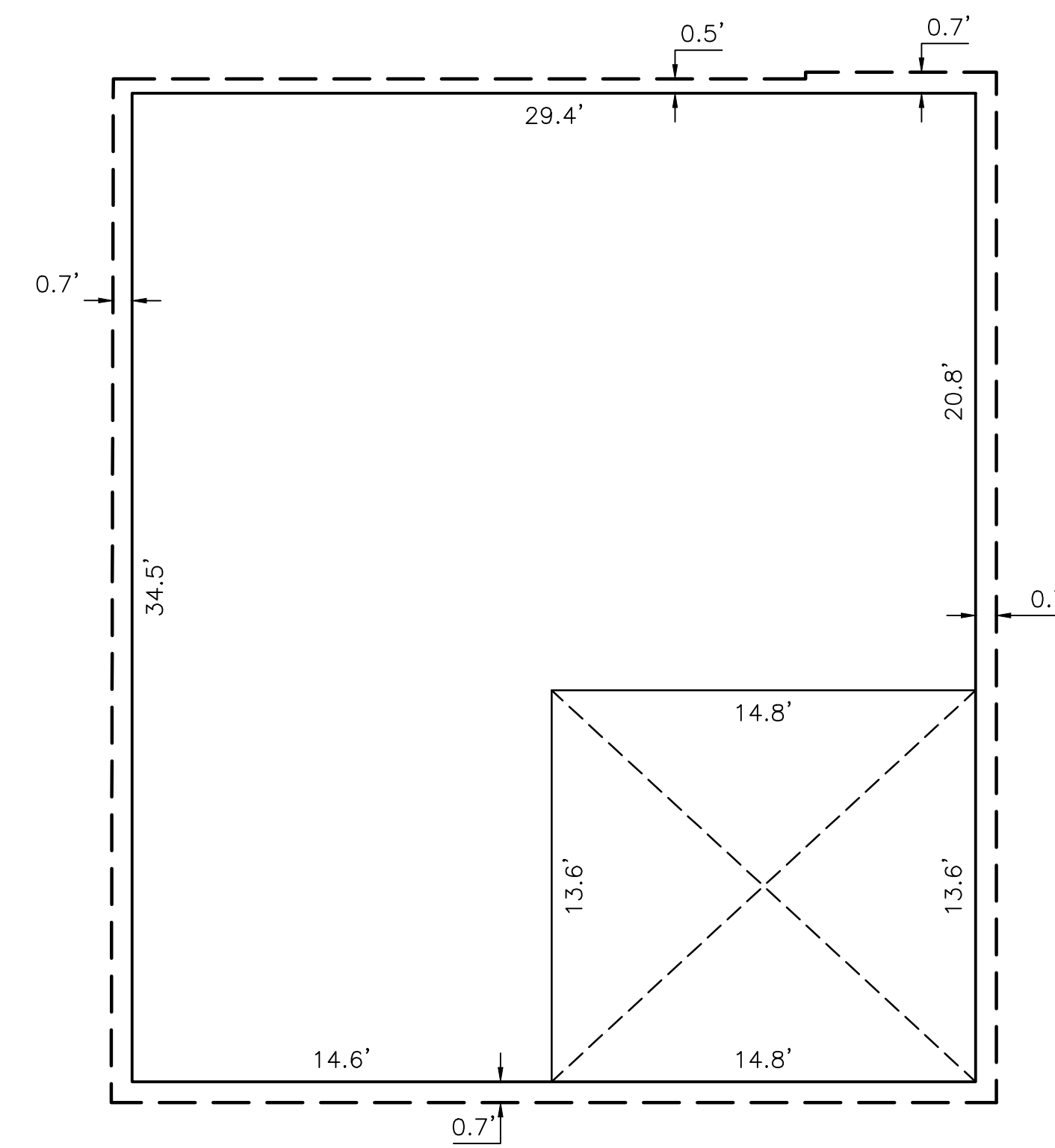

SECOND LEVEL PLAN

UNIT TYPE B		
UNIT NO.	LOWER UNIT BOUNDARY	UPPER UNIT BOUNDARY
1002		

**LEGEND**

- INDICATES INTERIOR BOUNDARY
- - - - INDICATES EXTERIOR FACE / COMMON WALL
- INDICATES FLOOR LIMITS

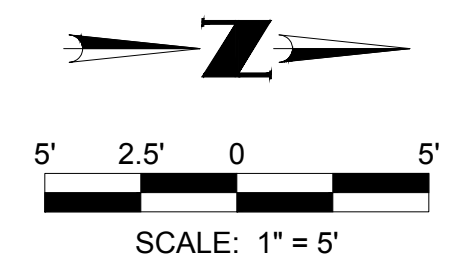

NO.	REVISION	DATE

**Coe & Van Loo Consultants, Inc.**

PRELIMINARY MAP

MOUNTAIN SHADOWS RESORT - CONDOMINIUM HOTEL  
PARADISE VALLEY, ARIZONA

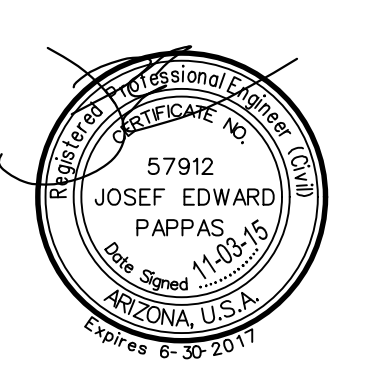

Printed By: Joep Print Date: November 23, 2015 Filename: N:\010245801\CADD\WEST\Condo\Preliminary\PS.CO.PRE.MAP.07.dwg



PRELIMINARY MAP

# "MOUNTAIN SHADOWS RESORT - CONDOMINIUM HOTEL"

A CONDOMINIUM UPON LOT 131 OF "MOUNTAIN SHADOW RESORT UNIT 2 - AMENDED VII" AS RECORDED  
 IN BOOK 1232 OF MAPS, PAGE 27, M.C.R. AND SITUATED IN THE SOUTHEAST QUARTER OF SECTION 8,  
 TOWNSHIP 2 NORTH, RANGE 4 EAST, OF THE GILA AND SALT RIVER BASE AND MERIDIAN,  
 MARICOPA COUNTY, ARIZONA

## UNIT PLANS

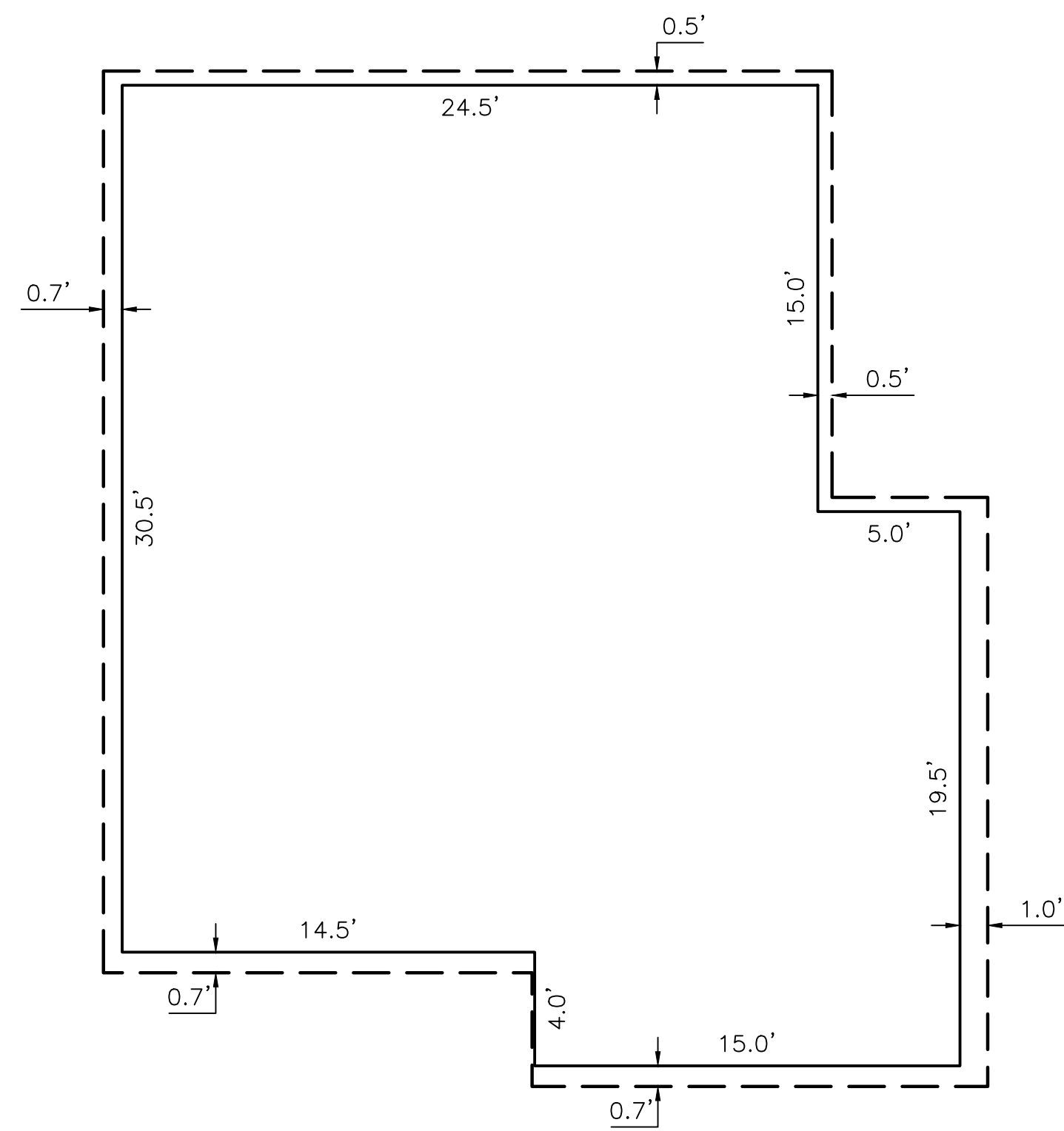

FIRST LEVEL PLAN

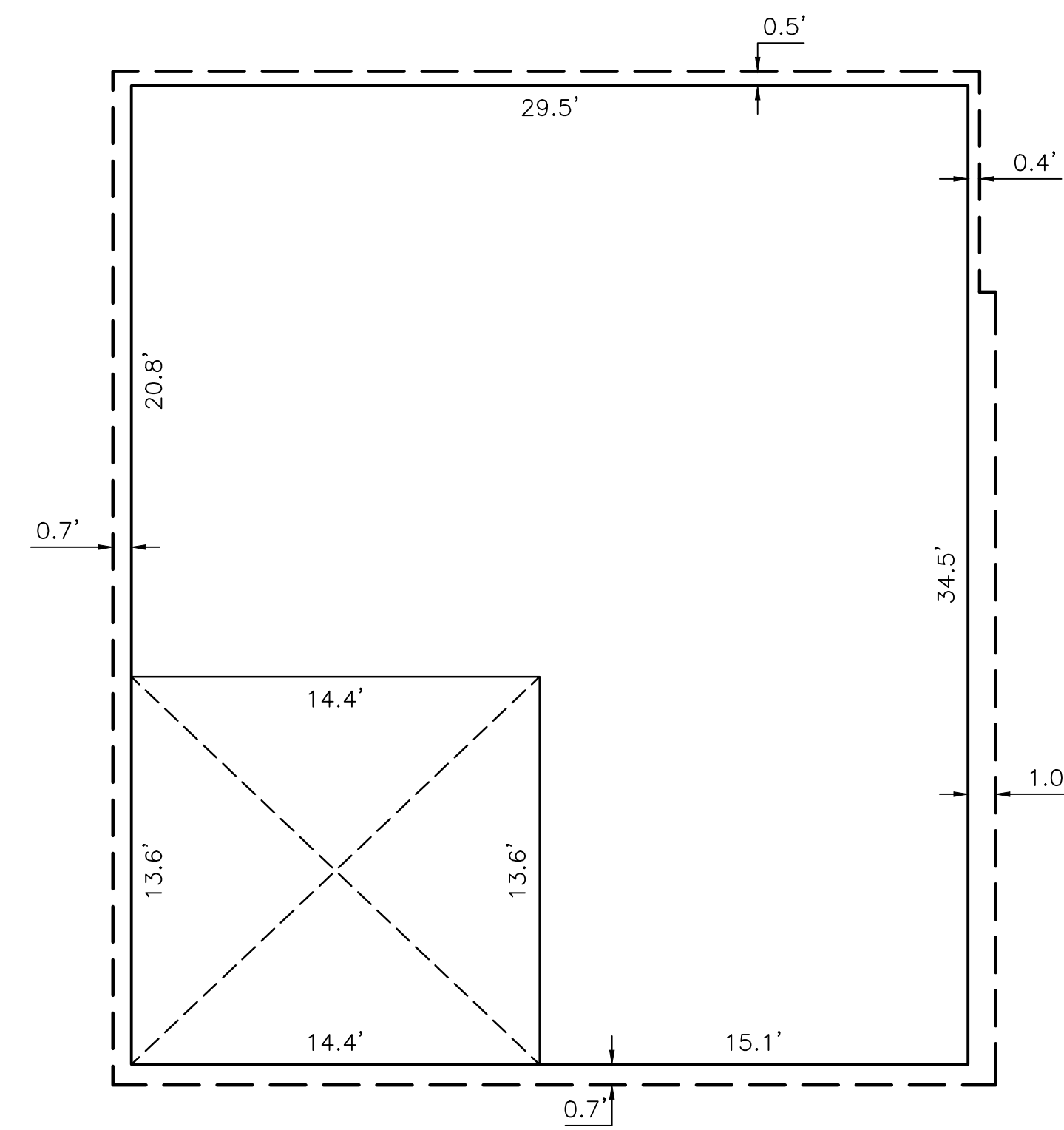

SECOND LEVEL PLAN

UNIT TYPE C		
UNIT NO.	LOWER UNIT BOUNDARY	UPPER UNIT BOUNDARY
1010		

**LEGEND**

- INDICATES INTERIOR BOUNDARY
- - - - INDICATES EXTERIOR FACE / COMMON WALL
- INDICATES FLOOR LIMITS

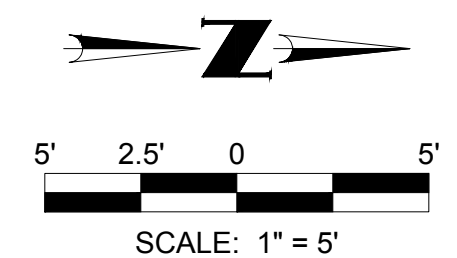

SCALE: 1" = 5'

NO.	REVISION	DATE

PRELIMINARY MAP

MOUNTAIN SHADOWS RESORT - CONDOMINIUM HOTEL  
 PARADISE VALLEY, ARIZONA

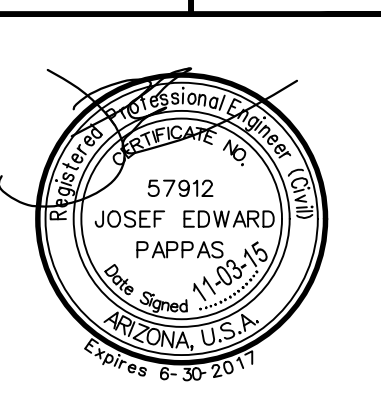

9 SHEET OF 14

CVL Contact: J. PAPPAS  
 CVL Project #: 01-0245801  
 CVL File #:

Coe & Van Loo Consultants, Inc.



PRELIMINARY MAP

# "MOUNTAIN SHADOWS RESORT - CONDOMINIUM HOTEL"

A CONDOMINIUM UPON LOT 131 OF "MOUNTAIN SHADOW RESORT UNIT 2 - AMENDED VII" AS RECORDED IN BOOK 1232 OF MAPS, PAGE 27, M.C.R. AND SITUATED IN THE SOUTHEAST QUARTER OF SECTION 8, TOWNSHIP 2 NORTH, RANGE 4 EAST, OF THE GILA AND SALT RIVER BASE AND MERIDIAN, MARICOPA COUNTY, ARIZONA

## UNIT PLANS

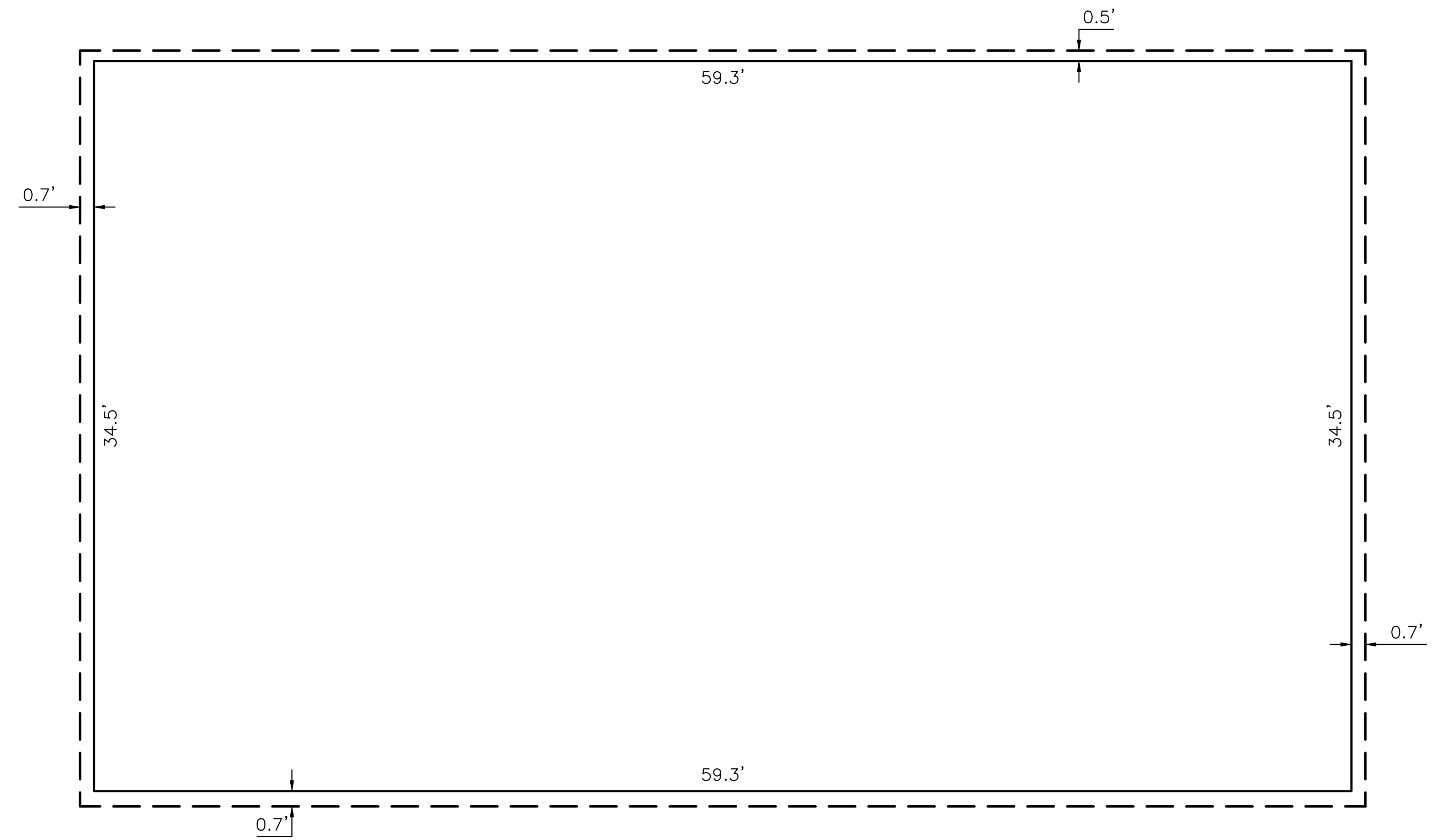
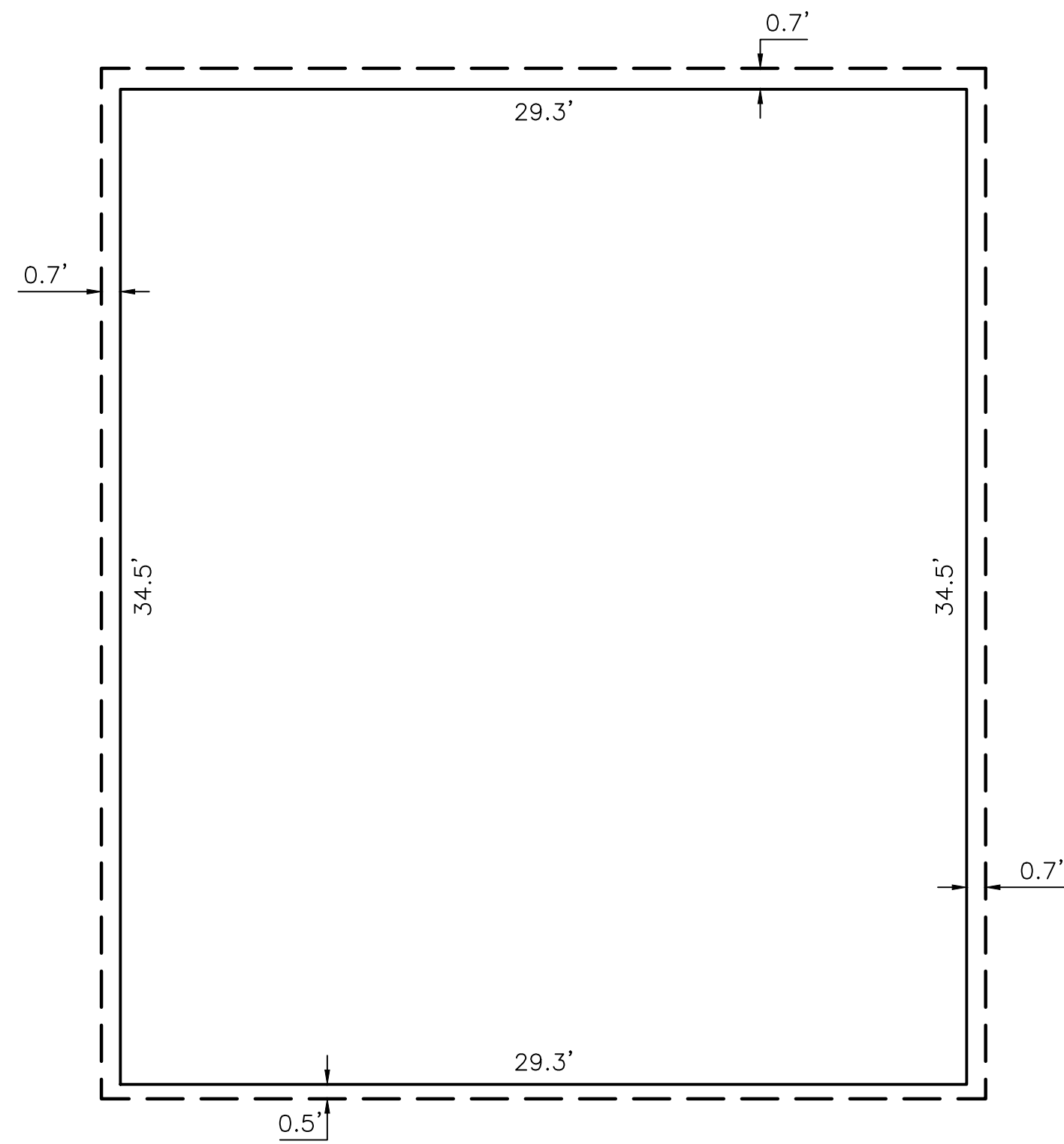

UNIT TYPE D		
UNIT NO.	LOWER UNIT BOUNDARY	UPPER UNIT BOUNDARY
1001		
1003		
1005		
1007		
1009		
1011		
1013		
1015		
1017		
1019		
2001		
2003		
2005		
2007		
2009		
2011		
2013		
2015		
2017		
2019		

UNIT TYPE H		
UNIT NO.	LOWER UNIT BOUNDARY	UPPER UNIT BOUNDARY
3006		
3008		

**LEGEND**

- INDICATES INTERIOR BOUNDARY
- - - INDICATES EXTERIOR FACE / COMMON WALL
- INDICATES FLOOR LIMITS

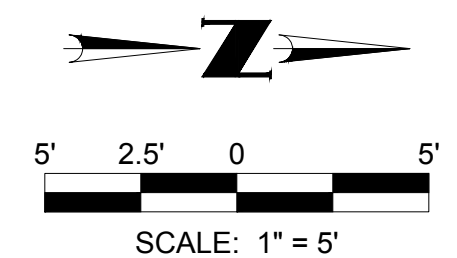

NO.	REVISION	DATE

**PRELIMINARY MAP**

**MOUNTAIN SHADOWS RESORT - CONDOMINIUM HOTEL**  
PARADISE VALLEY, ARIZONA

**Coe & Van Loo Consultants, Inc.**

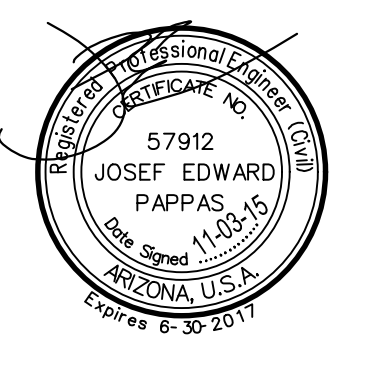

10 SHEET OF 14

CVL Contact: J. PAPPAS  
CVL Project #: 01-0245801  
CVL File #:

**CVL CONSULTANTS**  
4560 North 12th Street  
Phoenix, Arizona 85014  
602-264-6831  
www.cvlci.com

PRELIMINARY MAP

# "MOUNTAIN SHADOWS RESORT - CONDOMINIUM HOTEL"

A CONDOMINIUM UPON LOT 131 OF "MOUNTAIN SHADOW RESORT UNIT 2 - AMENDED VII" AS RECORDED IN BOOK 1232 OF MAPS, PAGE 27, M.C.R. AND SITUATED IN THE SOUTHEAST QUARTER OF SECTION 8, TOWNSHIP 2 NORTH, RANGE 4 EAST, OF THE GILA AND SALT RIVER BASE AND MERIDIAN, MARICOPA COUNTY, ARIZONA

## UNIT PLANS

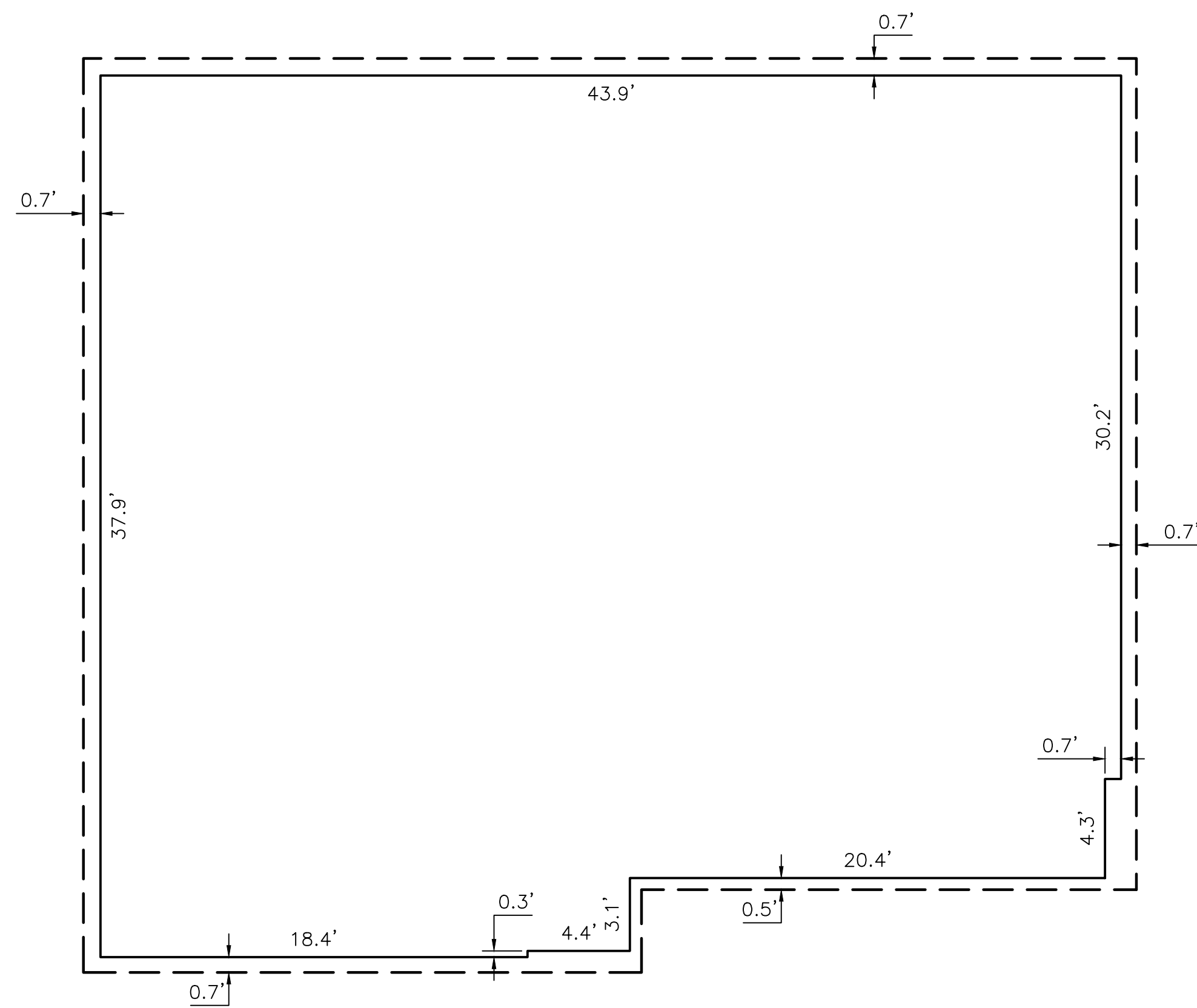

UNIT TYPE E		
UNIT NO.	LOWER UNIT BOUNDARY	UPPER UNIT BOUNDARY
1021		
2021		

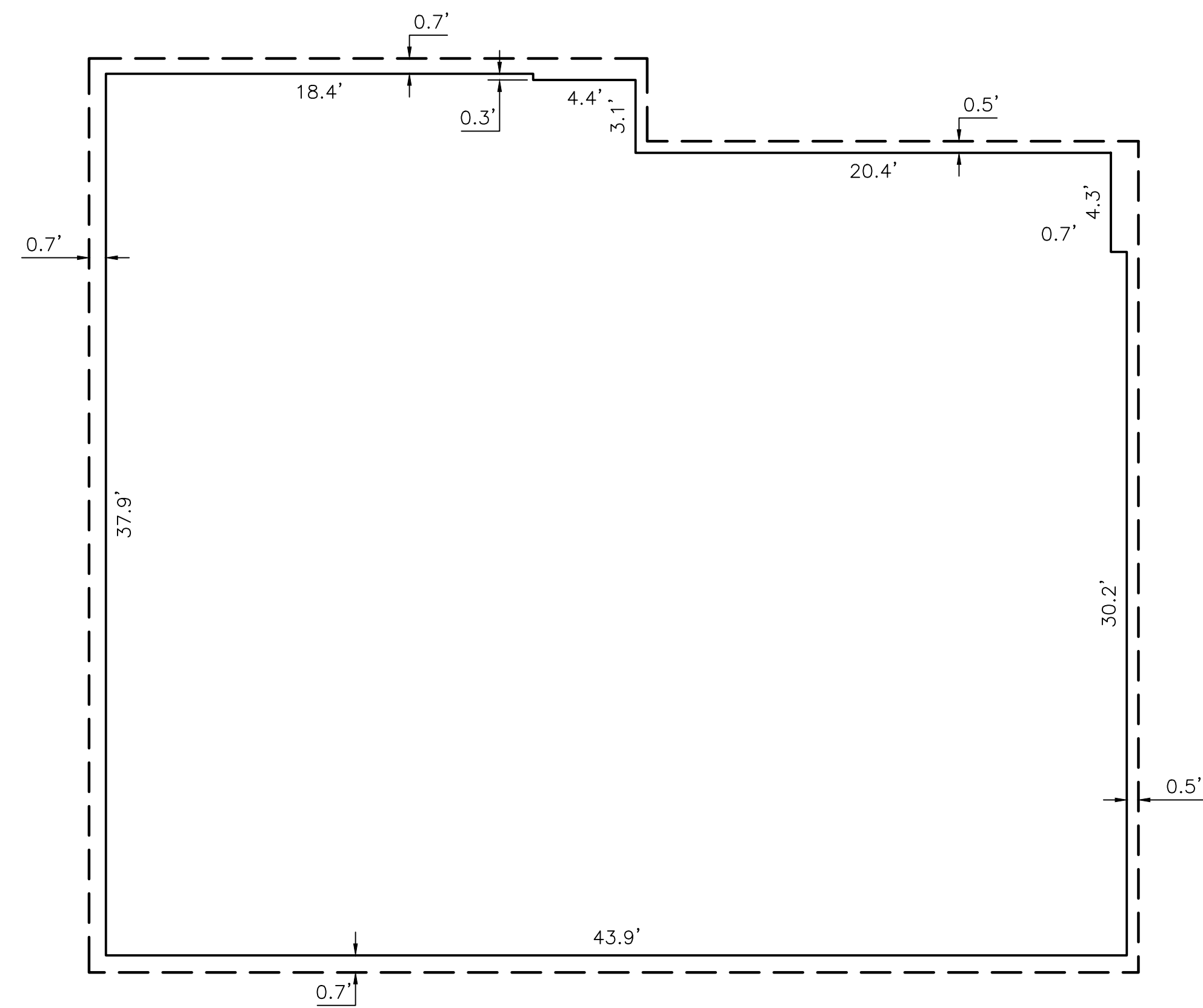

UNIT TYPE F		
UNIT NO.	LOWER UNIT BOUNDARY	UPPER UNIT BOUNDARY
1018		
2020		

### LEGEND

- INDICATES INTERIOR BOUNDARY
- INDICATES EXTERIOR FACE / COMMON WALL
- INDICATES FLOOR LIMITS

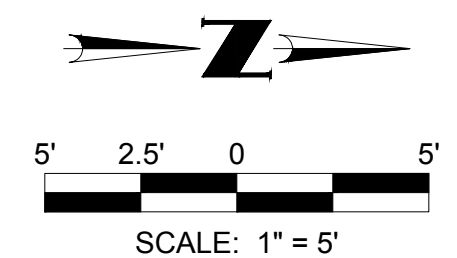

NO.	REVISION	DATE

**PRELIMINARY MAP**

**MOUNTAIN SHADOWS RESORT - CONDOMINIUM HOTEL**  
PARADISE VALLEY, ARIZONA

**Coe & Van Loo Consultants, Inc.**

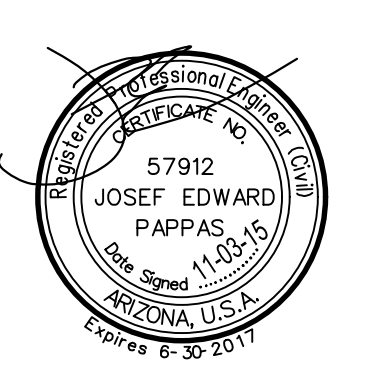

11 SHEET OF 14

CVL Contact: J. PAPPAS  
CVL Project #: 01-0245801  
CVL File #:

**CVL CONSULTANTS**

4560 North 12th Street  
Phoenix, Arizona 85014  
602-264-6831  
www.cvlci.com

PRELIMINARY MAP

# "MOUNTAIN SHADOWS RESORT - CONDOMINIUM HOTEL"

A CONDOMINIUM UPON LOT 131 OF "MOUNTAIN SHADOW RESORT UNIT 2 - AMENDED VII" AS RECORDED IN BOOK 1232 OF MAPS, PAGE 27, M.C.R. AND SITUATED IN THE SOUTHEAST QUARTER OF SECTION 8, TOWNSHIP 2 NORTH, RANGE 4 EAST, OF THE GILA AND SALT RIVER BASE AND MERIDIAN, MARICOPA COUNTY, ARIZONA

## UNIT PLANS

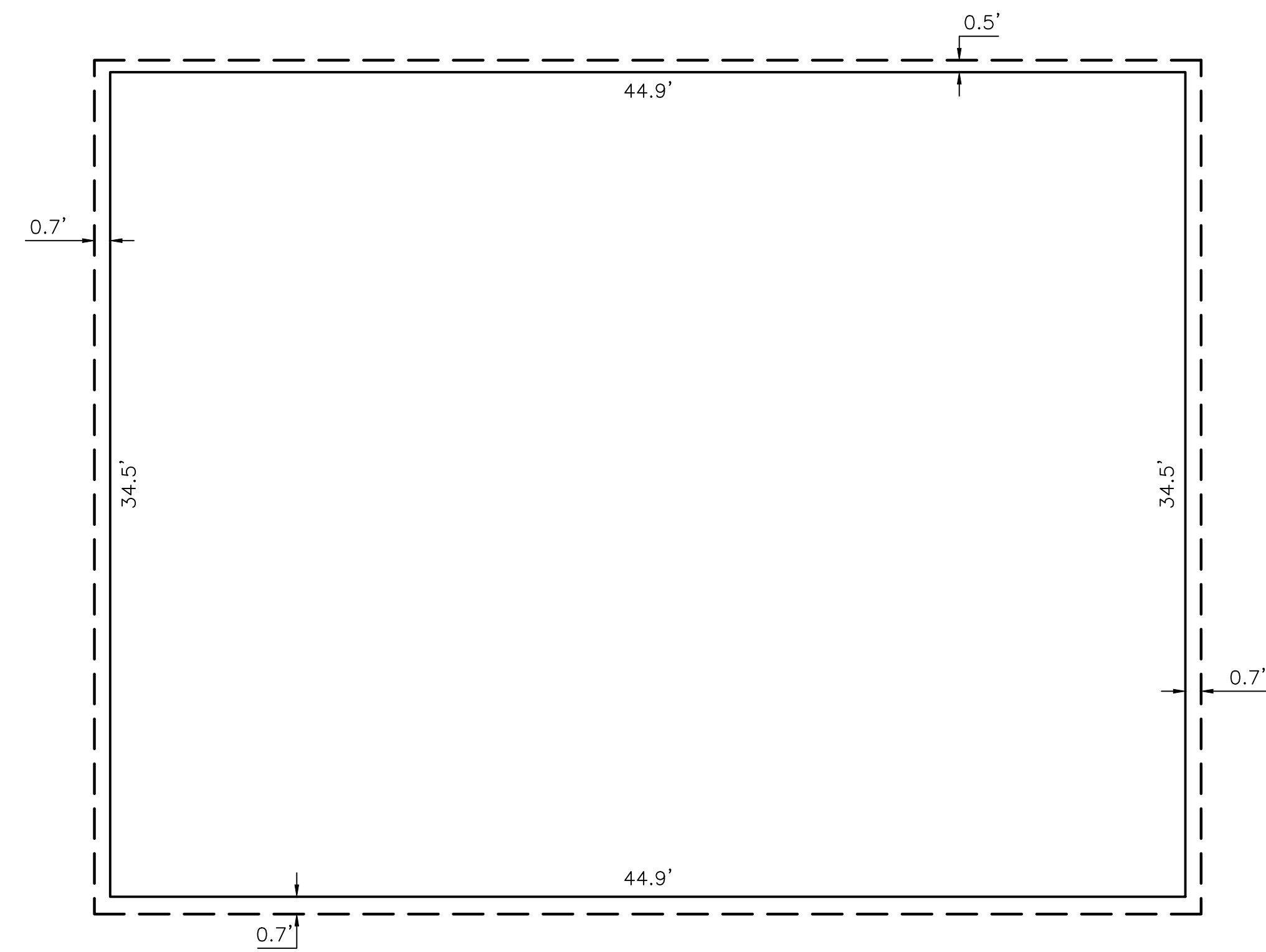
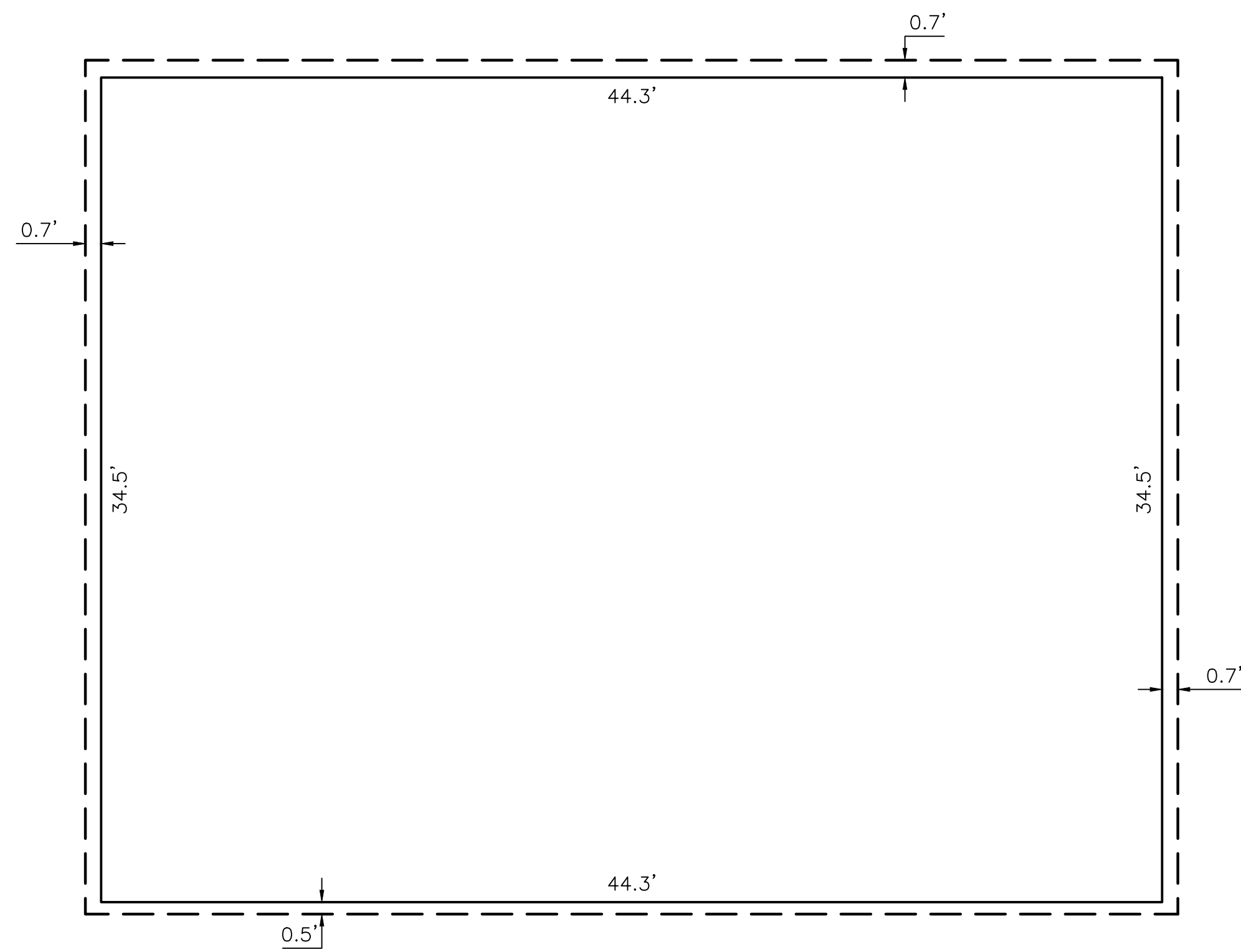

UNIT TYPE G-1		
UNIT NO.	LOWER UNIT BOUNDARY	UPPER UNIT BOUNDARY
3003		
3005		
3007		
3009		
3011		
3013		

UNIT TYPE G-2		
UNIT NO.	LOWER UNIT BOUNDARY	UPPER UNIT BOUNDARY
3002		
3004		

### LEGEND

-  INDICATES INTERIOR BOUNDARY
-  INDICATES EXTERIOR FACE / COMMON WALL
-  INDICATES FLOOR LIMITS

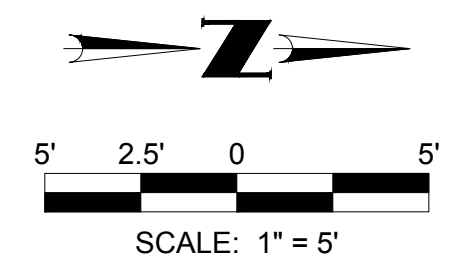

NO.	REVISION	DATE

**PRELIMINARY MAP**

**MOUNTAIN SHADOWS RESORT - CONDOMINIUM HOTEL**  
PARADISE VALLEY, ARIZONA

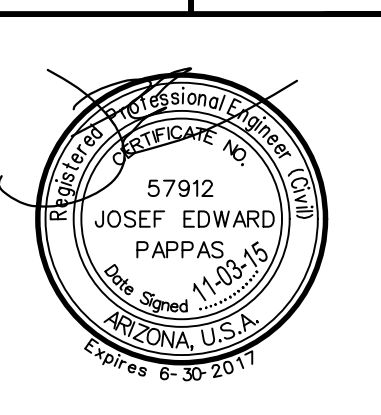

**12 SHEET OF 14**

CVL Contact: J. PAPPAS  
CVL Project #: 01-0245801  
CVL File #:

**Coe & Van Loo Consultants, Inc.**



PRELIMINARY MAP

# "MOUNTAIN SHADOWS RESORT - CONDOMINIUM HOTEL"

A CONDOMINIUM UPON LOT 131 OF "MOUNTAIN SHADOW RESORT UNIT 2 - AMENDED VII" AS RECORDED  
 IN BOOK 1232 OF MAPS, PAGE 27, M.C.R. AND SITUATED IN THE SOUTHEAST QUARTER OF SECTION 8,  
 TOWNSHIP 2 NORTH, RANGE 4 EAST, OF THE GILA AND SALT RIVER BASE AND MERIDIAN,  
 MARICOPA COUNTY, ARIZONA

## UNIT PLANS

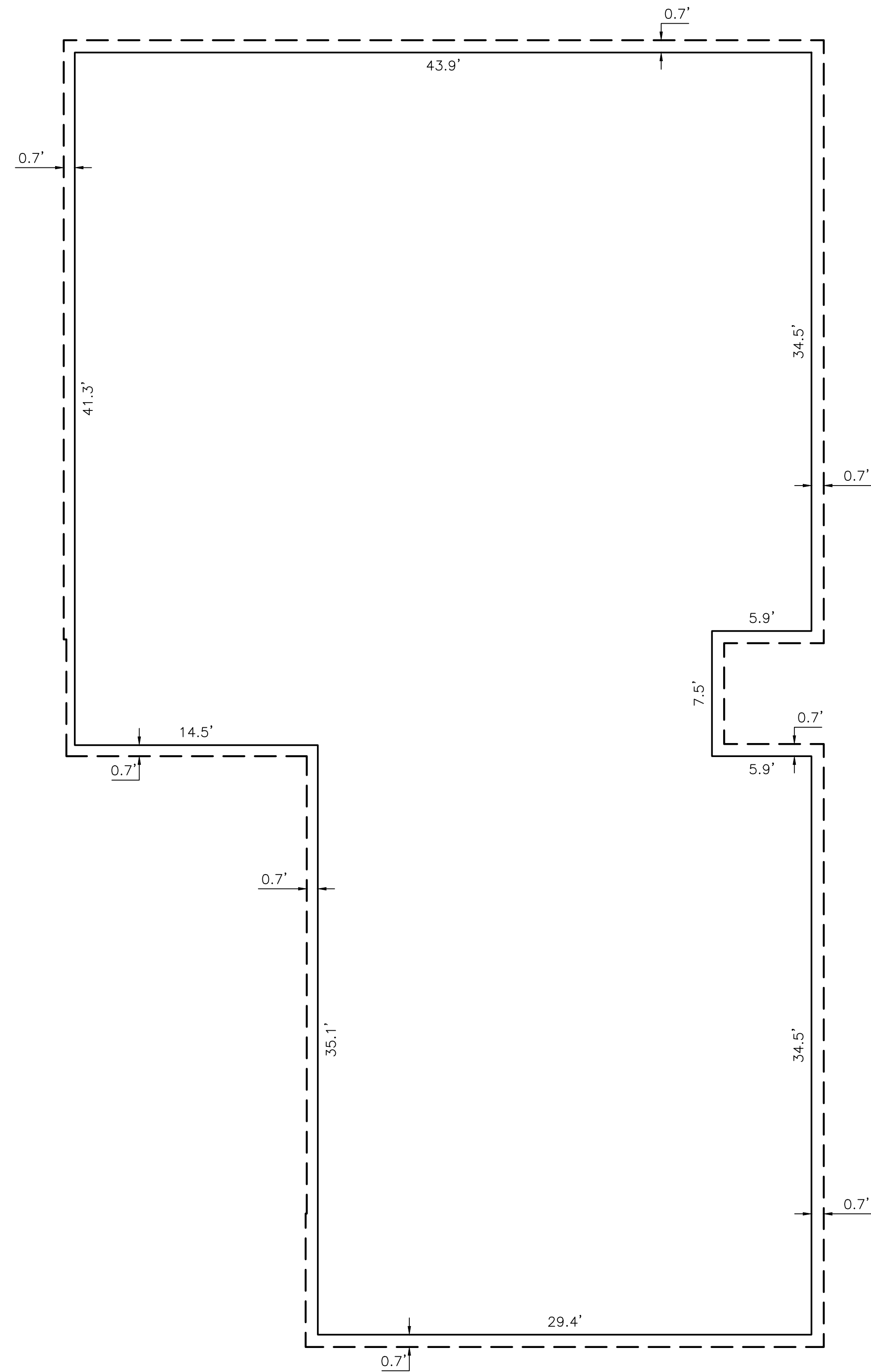

UNIT TYPE I		
UNIT NO.	LOWER UNIT BOUNDARY	UPPER UNIT BOUNDARY
3001		

- LEGEND**
- INDICATES INTERIOR BOUNDARY
  - - - INDICATES EXTERIOR FACE / COMMON WALL
  - INDICATES FLOOR LIMITS

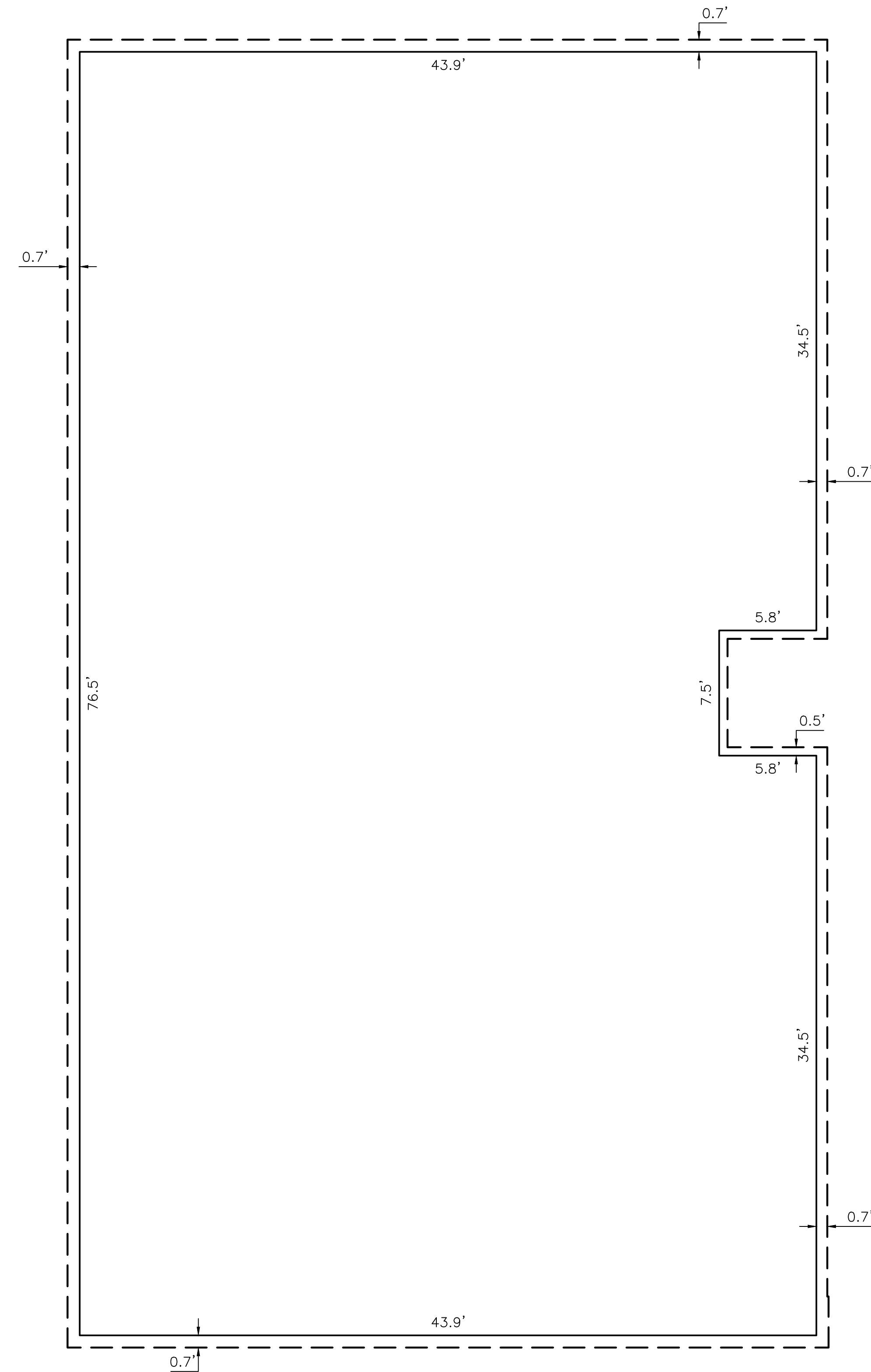

UNIT TYPE J		
UNIT NO.	LOWER UNIT BOUNDARY	UPPER UNIT BOUNDARY
3010		

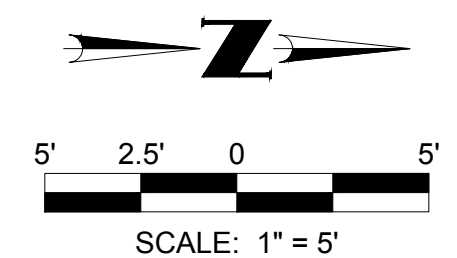

NO.	REVISION	DATE

**Coe & Van Loo Consultants, Inc.**

PRELIMINARY MAP

MOUNTAIN SHADOWS RESORT - CONDOMINIUM HOTEL  
 PARADISE VALLEY, ARIZONA

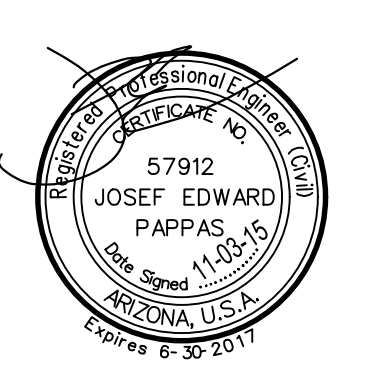

Printed By: Joep Print Date: November 23, 2015 Filename: N:\010245801\CADD\WEST\Condo\Preliminary\PS CO PRE.MAP.07.dwg

PRELIMINARY MAP

# "MOUNTAIN SHADOWS RESORT - CONDOMINIUM HOTEL"

A CONDOMINIUM UPON LOT 131 OF "MOUNTAIN SHADOW RESORT UNIT 2 - AMENDED VII" AS RECORDED IN BOOK 1232 OF MAPS, PAGE 27, M.C.R. AND SITUATED IN THE SOUTHEAST QUARTER OF SECTION 8, TOWNSHIP 2 NORTH, RANGE 4 EAST, OF THE GILA AND SALT RIVER BASE AND MERIDIAN, MARICOPA COUNTY, ARIZONA

## VERTICAL SCHEMATIC

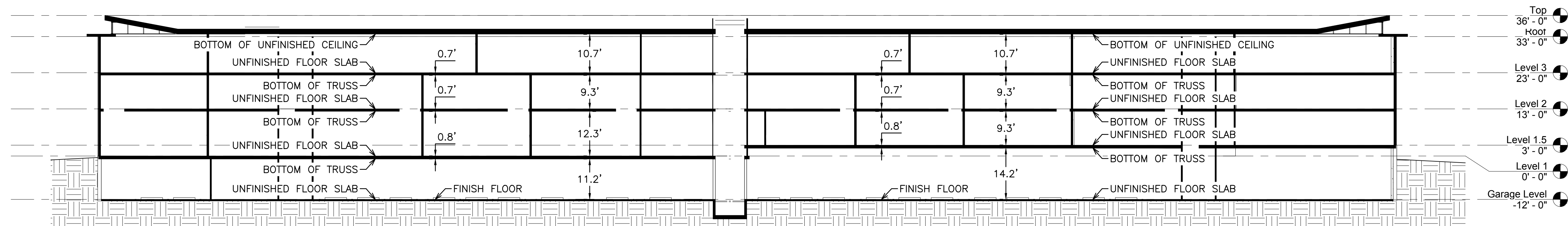

VERTICAL SCHEMATIC

NO.	REVISION	DATE

**Coe & Van Loo Consultants, Inc.**

PRELIMINARY MAP

MOUNTAIN SHADOWS RESORT - CONDOMINIUM HOTEL  
 PARADISE VALLEY, ARIZONA

