

November 20, 2018

Ritz-Carlton Resort Parcel C

Paradise Valley

Minor SUP Amendment

Prepared for:

Five Star Resort Owner, LLC

6720 N. Scottsdale Road, Suite 130
Scottsdale, AZ 85253

Contact: Gerald C. Ayoub
480.603.1387



Job # 01.0268908

Prepared by:

CVL Consultants

4550 N 12th Street
Phoenix, AZ 85014

Contact: Heidi Tilson
602.264.6831

Minor SUP Amendment

Contents

Stipulation 29 1
Stipulation 45 c. 2

Appendix

Appendix A Guard House Exhibits
Appendix B Retaining Wall Exhibit

Ritz-Carlton Parcel C (Area C) is a 39 lot, 17.3-acre, single-family detached residential neighborhood within the 105-acre master-planned community known as The Ritz-Carlton. Lots within Parcel C range in size from 12,000 square-feet to over 26,000 square-feet.

CVL Consultants, Inc., on behalf of Five Star Resort Owner, LLC, is seeking a Minor Amendment to the Special Use Permit for the Ritz Carlton Development, as written in Ordinance Number 694, SUP-15-01.

Stipulation 29

The first request is a minor amendment to Stipulation 29 which limits the square feet and height of accessory and service structures. Per the stipulation, guard houses are limited to eight-hundred (800) square feet of floor area and a maximum height of sixteen (16) feet. This request is to increase the allowable square feet of the guard house to seventeen-hundred (1,700) square feet and the maximum height of the building to twenty (20) feet. The requested 1,700 square foot guard house will be accounted for and deducted from the allowable 15,000 square feet for accessory structures per the SUP.

The site has been designed to allow for a larger guard house as it fits the overall vision of the area. The guard house itself is approximately 616 square-feet. In addition to creating a comfortable location for the guard; the building also includes a storage and mechanical room. Large packages that are not left at the mail boxes will be delivered to the guard house, including deliveries from UPS and FedEx. The mechanical will house the mechanical unit required to serve the guard house. The guard house footprint also includes a golf cart parking stall for the guard. The guard will park their personal vehicle at the Villas.

The guard house structure includes a 1,011 square-foot overhang. The overhang, or entry porte cochere, extends from the guard house north over the proposed travel lanes. The entry porte cochere serves as the threshold to the community and a distinct architectural feature that relates directly to the homes within. It delineates exactly where motor vehicles need to enter while providing another layer of security. Covered porte cocheres can be seen all throughout the valley and other communities as a beautiful entry marker and necessary feature for this type of high end community.

The site has been designed with multiple gate locations. A barrier gate arm will be located at the guard house. No traffic will be able to pass without first speaking with the guard. Two sets of gates will be located past the guard house. There will be a set of gates just west of the guard house for the five private lots. There will also be a set of gates south of the guard house for the remaining 34 residences. As part of being a branded residential product, the Ritz-Carlton Hotel is responsible for providing the security services to Parcel C. Homeowners within Parcel C will have 24/7 access through the gate via RFID readers, key pads, etc. The security office within the Ritz-Carlton Hotel is manned 24/7. Should the gatehouse at Parcel C ever be unmanned, camera and intercom communication will be provided for visitor arriving at the Parcel C gatehouse via the staff at the Ritz-Carlton Hotel security office. The Hotel security office will have the ability to (remotely) open and close the Parcel C gates, as needed.

The additional requested height is necessary to accommodate emergency vehicles, such as fire trucks. Per City of Phoenix Fire Code (503.2.1) the minimum unobstructed vertical clearance is 14 feet. In addition, the requested 20 foot height will allow for grading and construction tolerances as well as architectural building elements that may extend above the roof line.

Refer to Appendix B for the proposed guard house exhibits and details.

Stipulation 45 c.

The second request is a minor amendment to Stipulation 45 c. The stipulation limits lot walls to a maximum height of six (6) feet. This request is to increase the allowable wall height to a maximum of nine (9) feet. The request is to allow a combination retaining wall, up to three (3) feet in height, with a six (6) foot property wall on top.

Visually, the resident located on the high lot will see a 6 foot wall and the resident on the low lot will potentially see up to a 3 foot retaining wall topped by a 6 foot privacy wall, up to a 9 foot wall in total. The additional height in the wall will allow for a step down in the lots to accommodate the shared driveway concept presented by the architect.

The request is for walls within the individual areas, along the access and utility easement, and along the proposed Palmeraie Boulevard. In order to minimize the visual impact of the tall walls along Palmeraie Boulevard, vertical elements, such as landscaping and entry monuments, will be used shield the walls. Landscaping will also be used within the community to shield the wall. Trees and large shrubs will be planted along the roadway which will minimize the view of the tall rear and side walls. The perimeter walls along Lincoln Drive and Mockingbird Lane will remain as constructed and approved in the Special Use Permit.

An alternate to the 9' walls along the perimeter is retaining wall with an offset property wall. The retaining wall would be a maximum of 3 foot high and the property wall would be 6 foot. Per Town Code, the separation between the two walls is 10 foot. With this Minor SUP Amendment, we're also requesting a reduction to the horizontal spacing between the walls from 10 foot to 4 foot. With the bottom, outside, wall being retaining and the top, inside, wall being a standard wall, 4 foot separation will allow spacing for the two separate footers. As design of Parcel C continues, this option may be used along Palmeraie Boulevard and Horseshoe Lane as an alternate to the 6 foot wall atop the retaining wall or atop a slope along the roadway. The reduced separation will allow for flatter slope between the lots and Palmeraie Boulevard. The offset wall will be visually more appealing than a solid 9 foot wall. The 4 foot separation will allow for planting and landscape to beautify the perimeter.

Refer to Appendix C for requested wall locations and wall details. The location and height of the interior walls are subject to change due to continuing design of Parcel C. The maximum height of 9' will be held throughout the development.

In conclusion, the requested amendments will not negatively impact the Ritz-Carlton development. Area C will remain in substantial conformance with the approved SUP. The amendments will improve the overall design and development of the site.

APPENDIX A

GUARD HOUSE



The Ritz-Carlton Resort



THE RITZ-CARLTON®

Parcel C Site Plan



October 15, 2018
N:\01\0268901\Graphics\Exhibits\Ritz - Parcel C - SUP Amendment.indd



LINCOLN DRIVE

MOCKINGBIRD LANE

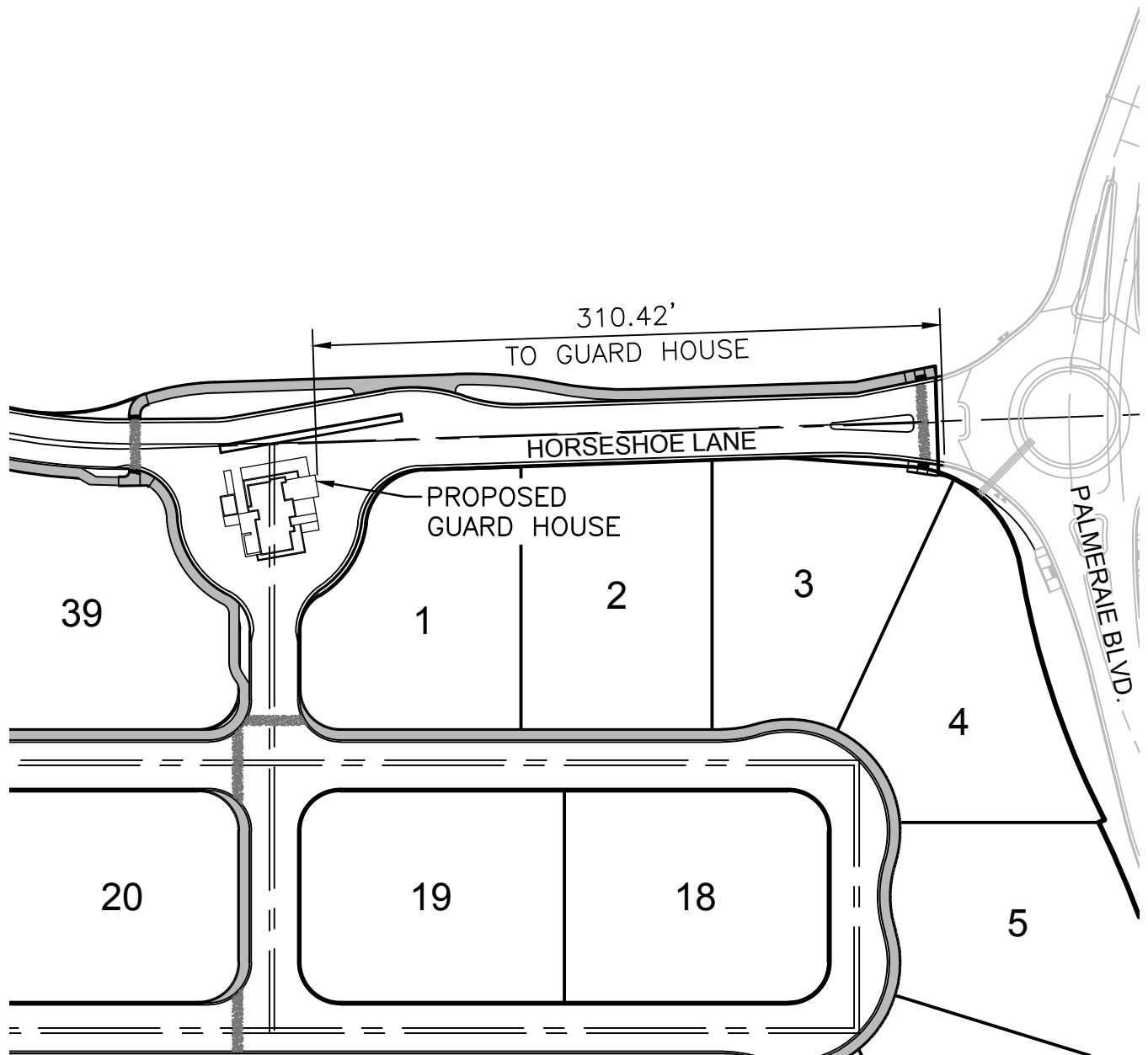

SCALE 1" = 80'

EXHIBIT

4550 North 12th Street
Phoenix, Arizona 85014
Phone 602-264-6831
<http://www.cvlci.com>

RITZ CARLTON - PARCEL C

STACKING DISTANCE EXHIBIT



1 OF 1



[3] BUILDING SECTION 3 COLOR
3/16" = 1'-0"

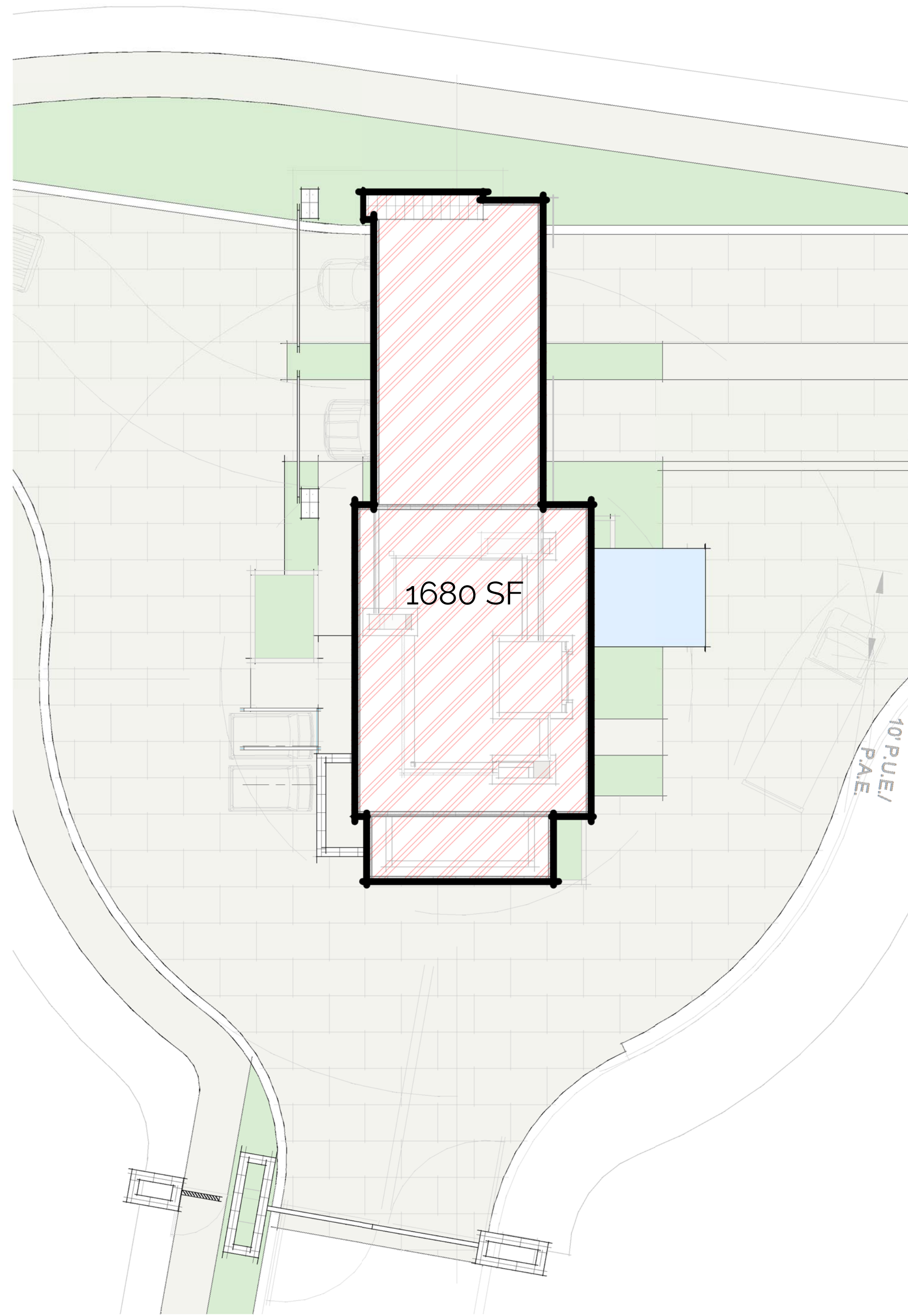

[2] ROOF DRIP LINE
1" = 10'-0"

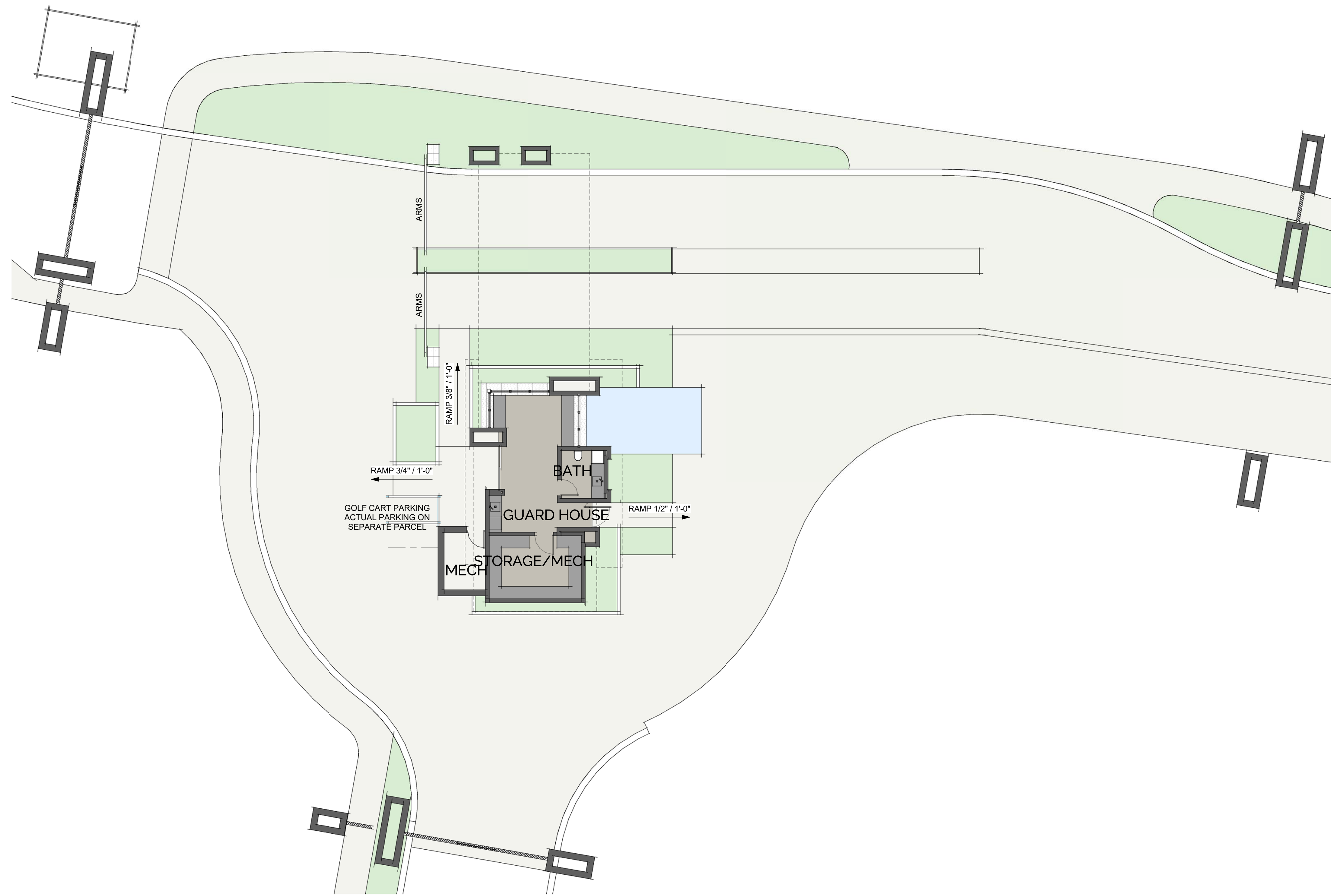

[1] LEVEL 1 Color Plan
1" = 10'-0"

KEYNOTES

FOR _____
DATE _____
REV. _____

RITZ CARLTON RESIDENCE GUARD HOUSE

TRAFFIC ARM

OVERHANG
1011 SF

WATER FEATURE

GH
616 SF

MECH YARD
87 SF

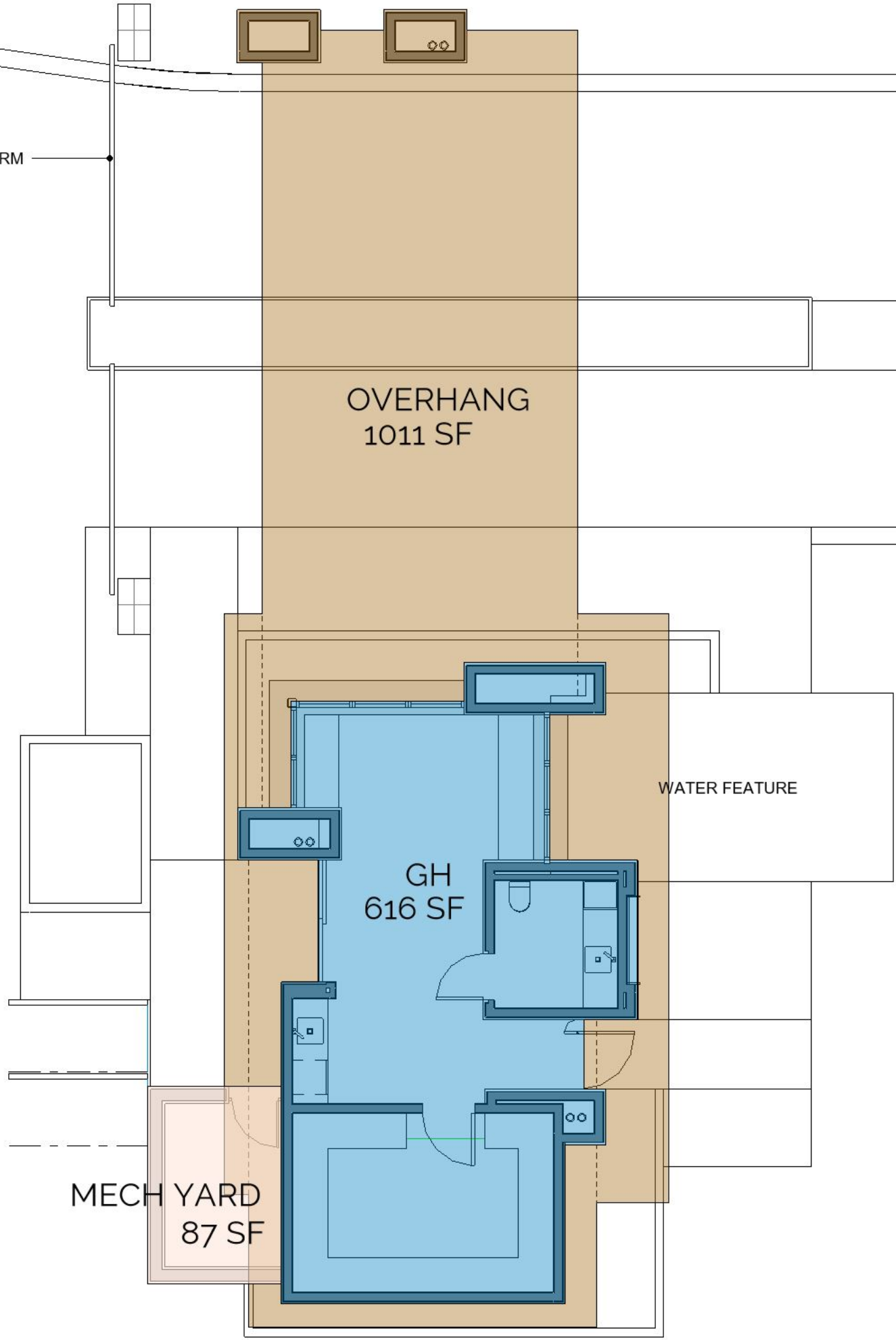



THE RITZ-CARLTON
RESIDENCES

PARADISE VALLEY







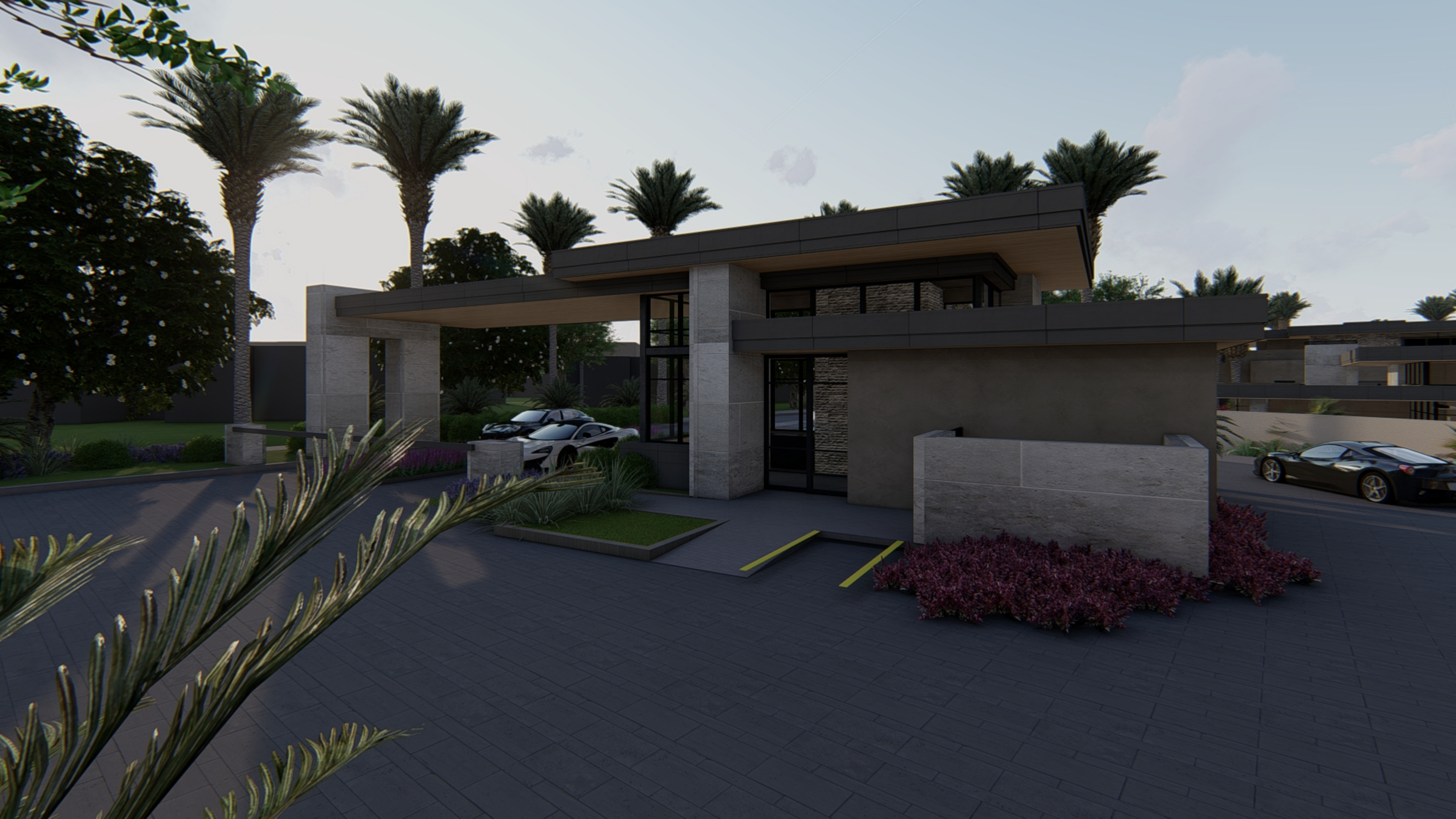

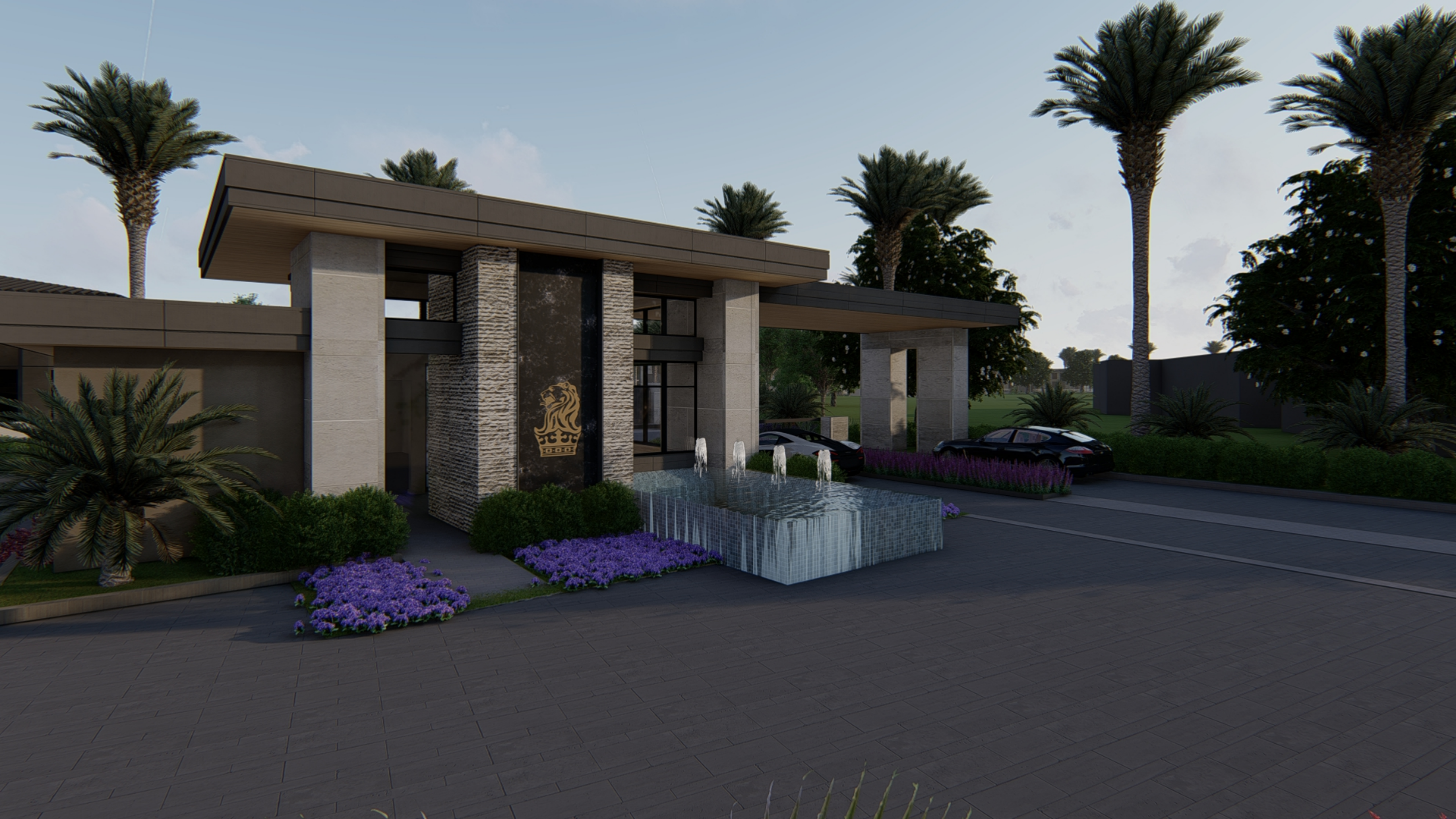





APPENDIX B

RETAINING WALLS







The Ritz-Carlton Resort



THE RITZ-CARLTON®

Parcel C Retaining Wall

-  Existing Retaining Wall
-  7' - 8' Wall
-  8' - 9' Wall
-  1' - 3' Retaining Wall
4' Offset Property Wall

MOCKINGBIRD LANE



October 15, 2018

N:\01\0268901\Graphics\Exhibits\Ritz - Parcel C - SUP Amendment.indd



LINCOLN DRIVE

N:\1010268901\CADD\Parcel C\EXHIBITS\IDX.GRAD.dwg Juanl September 26, 2018

**NOT FOR
CONSTRUCTION**

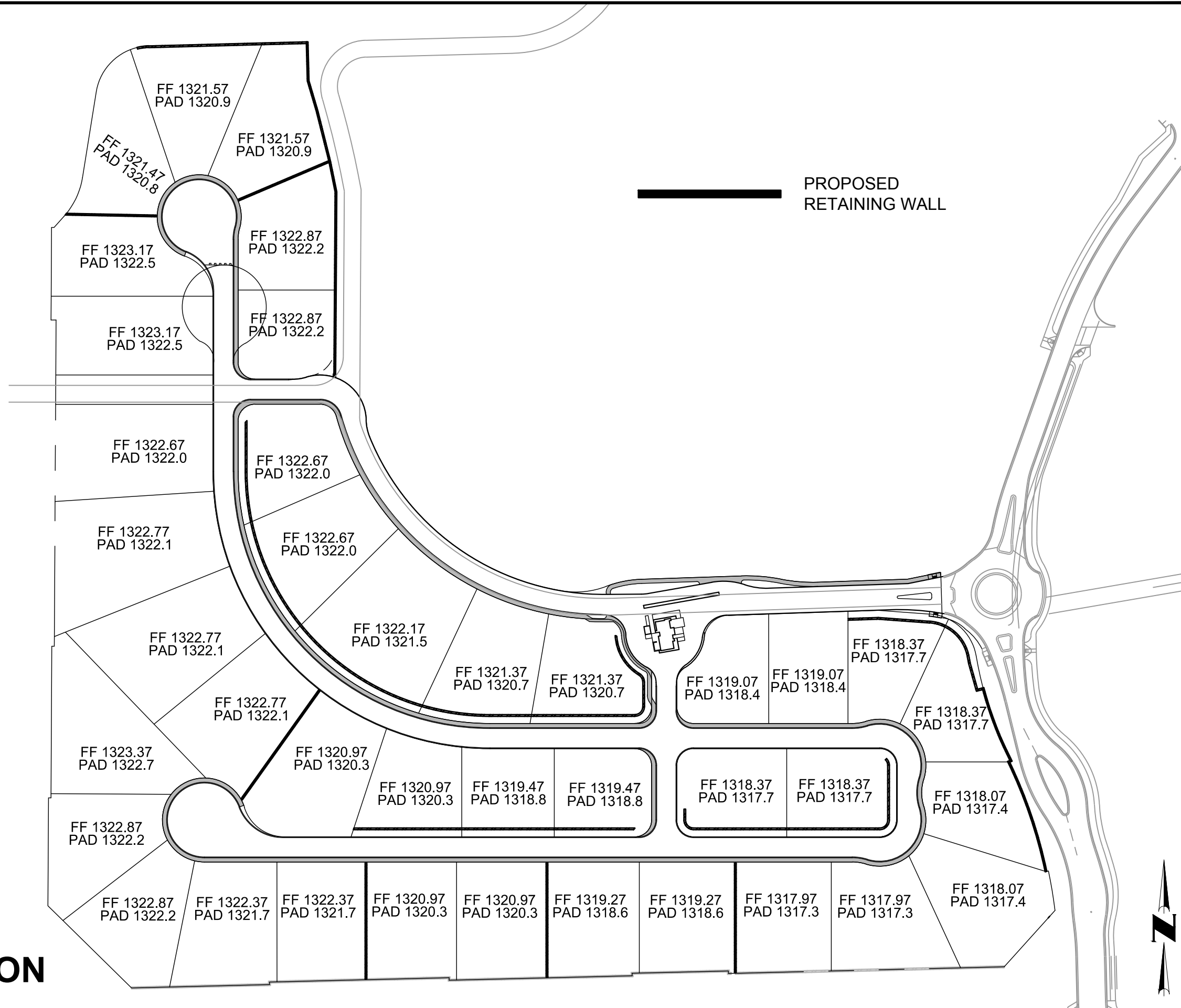

PROPOSED
RETAINING WALL



RITZ - PARCEL C

RETAINING WALL EXHIBIT

SCALE 1" = 120'
EXHIBIT
4550 North 12th Street
Phoenix, Arizona 85014
Phone 602-264-6831
<http://www.cvlci.com>

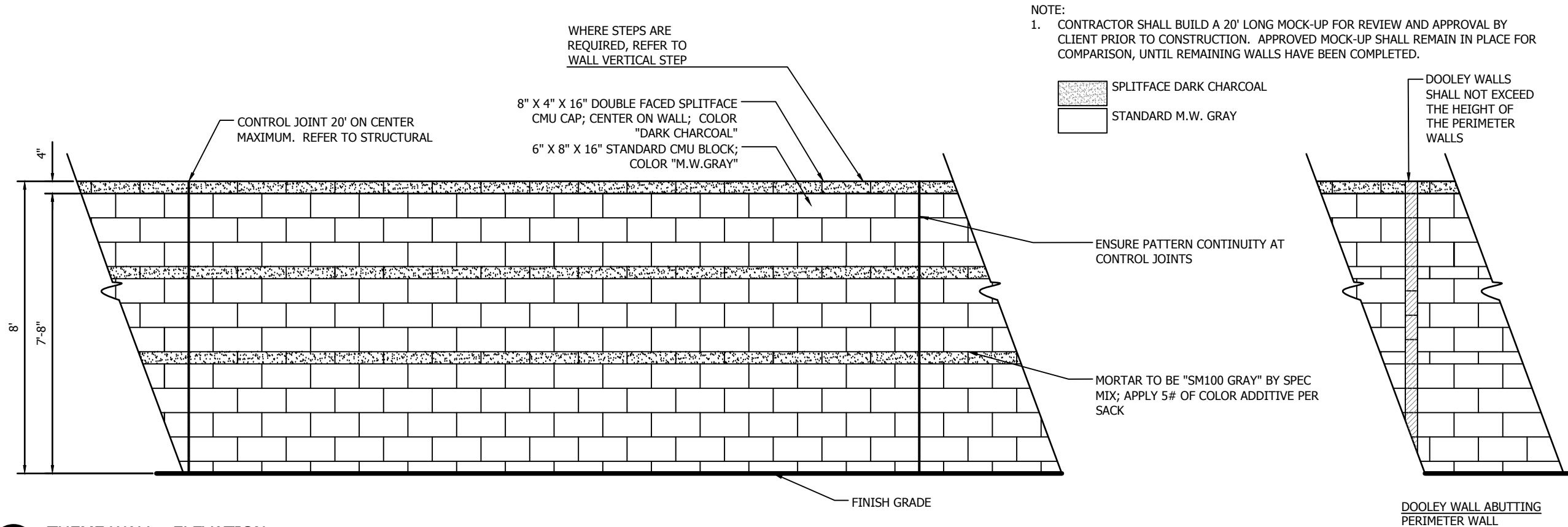

00 THEME WALL - ELEVATION

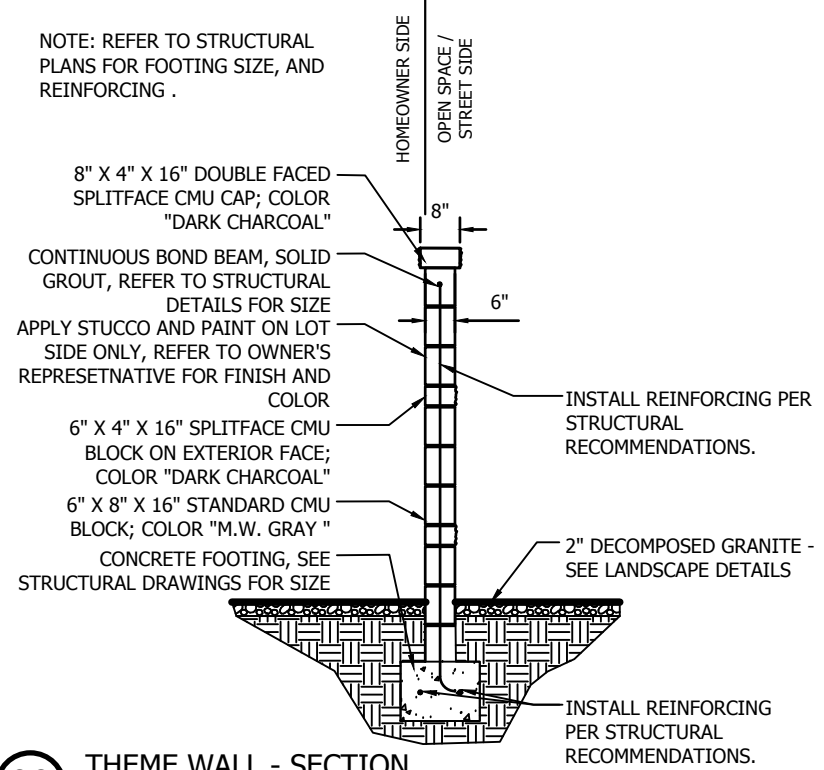

00 THEME WALL - SECTION

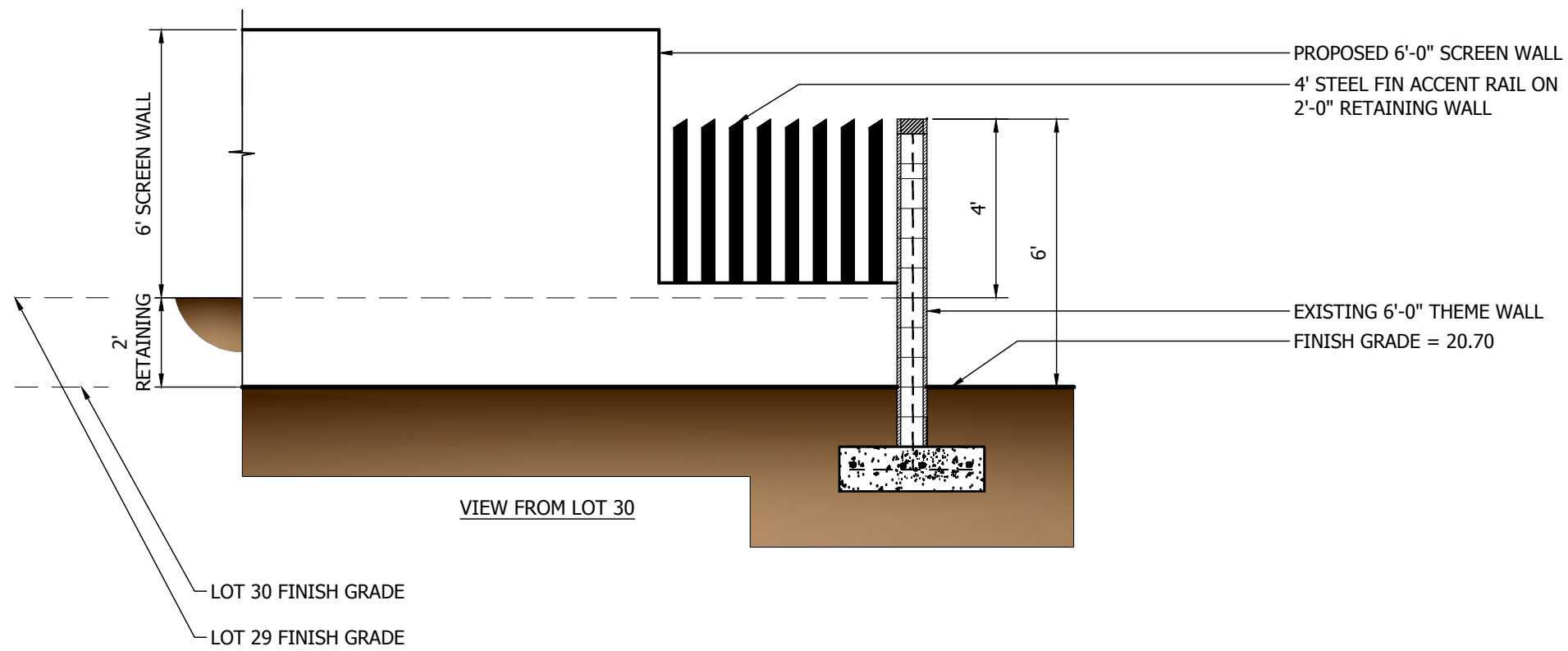
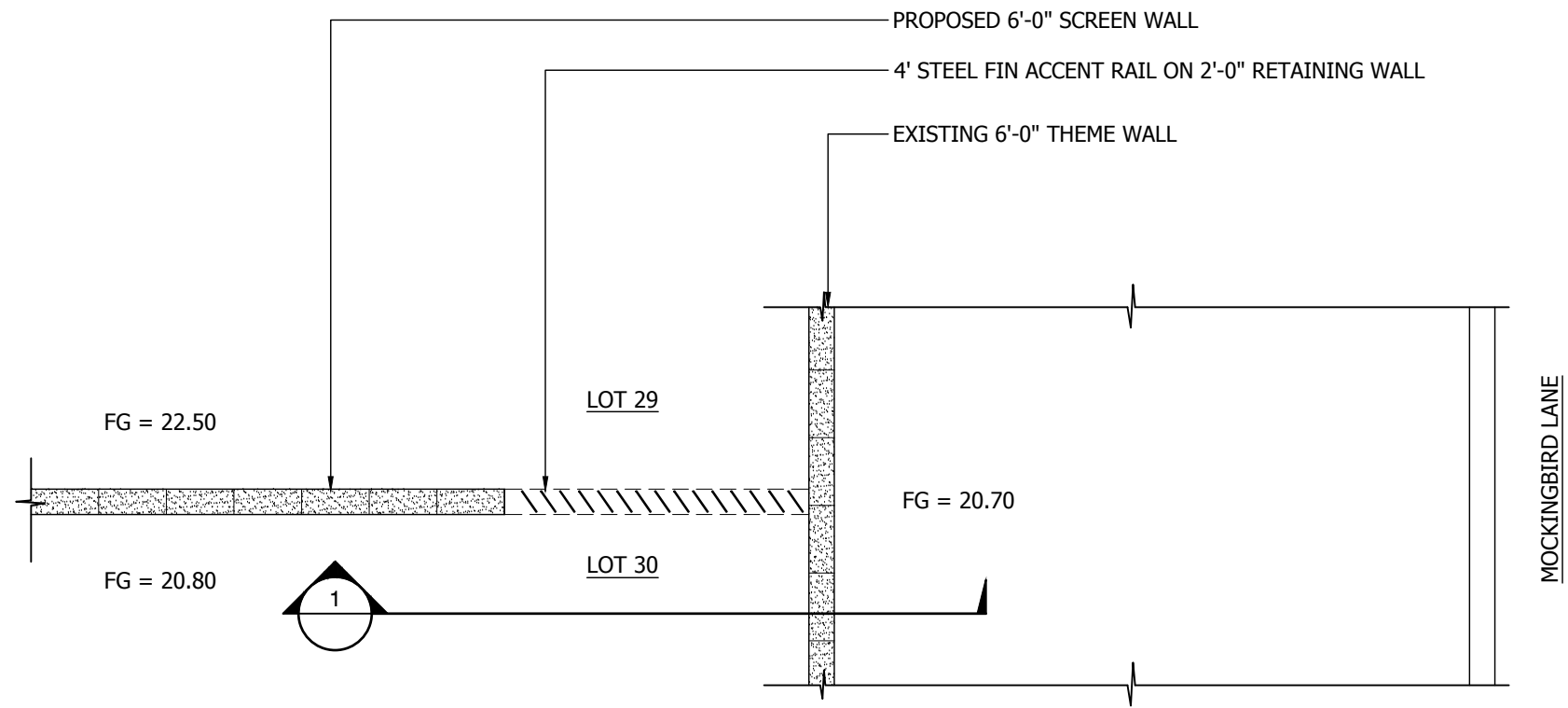

NTS.

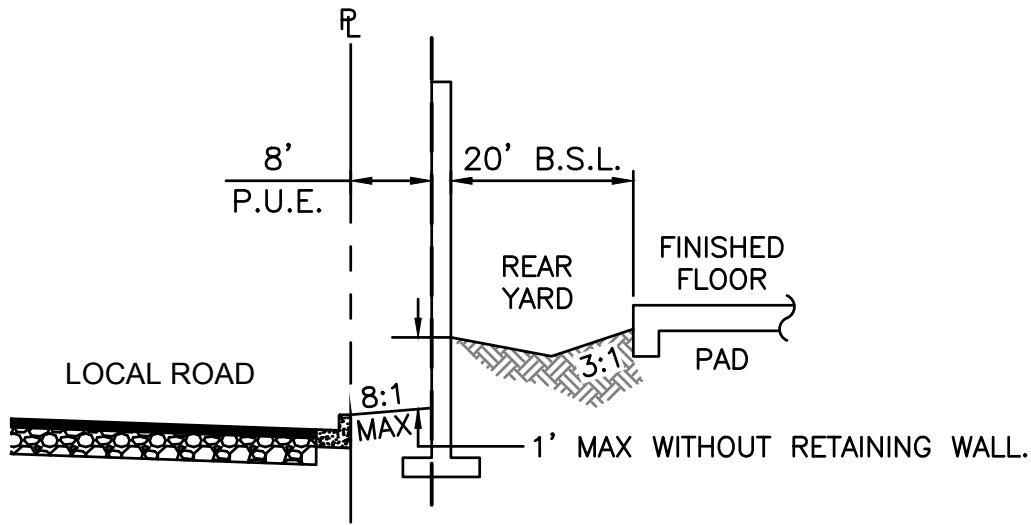

REAR YARD TO LOCAL STREET

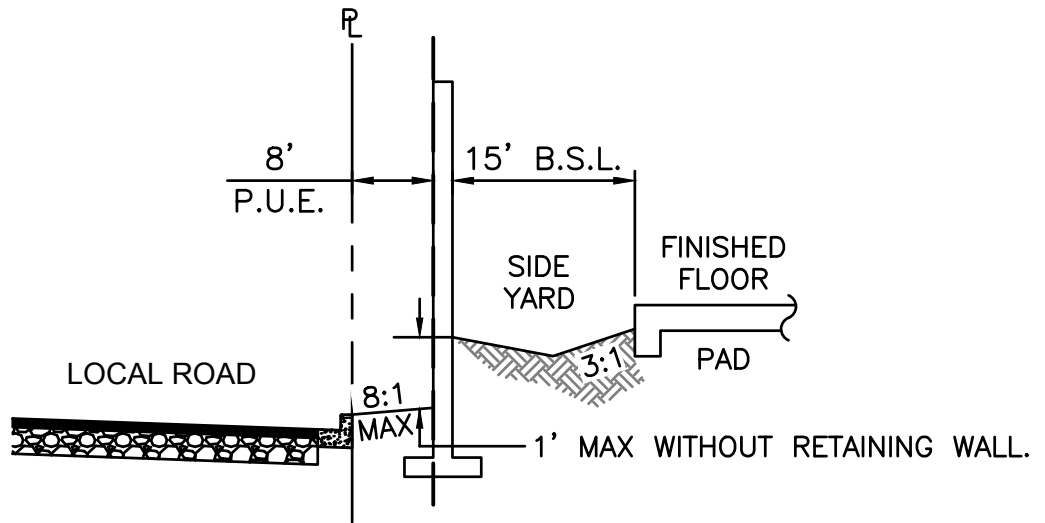

SIDE YARD TO LOCAL STREET

**NOT FOR
CONSTRUCTION**

SCALE = N.T.S. EXHIBIT	RITZ - PARCEL C	 CELEBRATING 60 YEARS 1 OF 3
4550 North 12th Street Phoenix, Arizona 85014 Phone 602-264-6831 http://www.cvlci.com	GRADING SECTIONS	

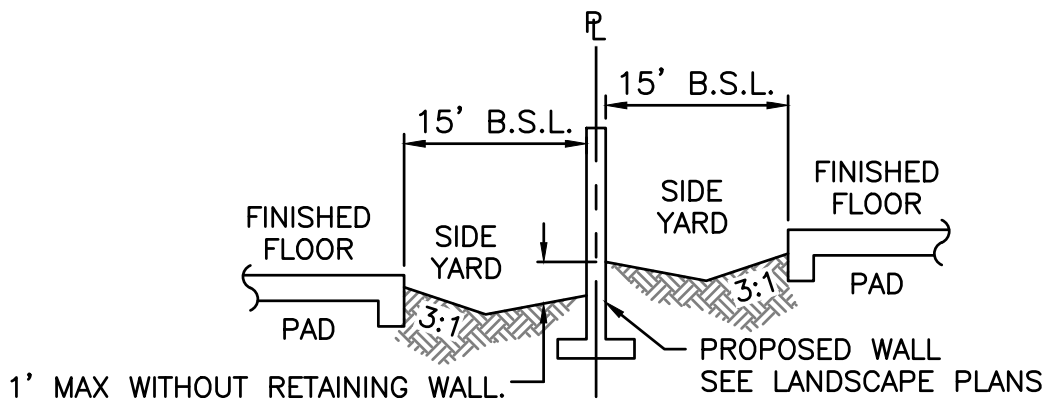

SIDE YARD TO SIDE YARD

**NOT FOR
CONSTRUCTION**

SCALE = N.T.S.	<h1>RITZ - PARCEL C</h1>	 CVL CONSULTANTS <small>CELEBRATING 60 YEARS</small>
EXHIBIT		
4550 North 12th Street Phoenix, Arizona 85014 Phone 602-264-6831 http://www.cvlci.com	<h1>GRADING SECTIONS</h1>	2 OF 3

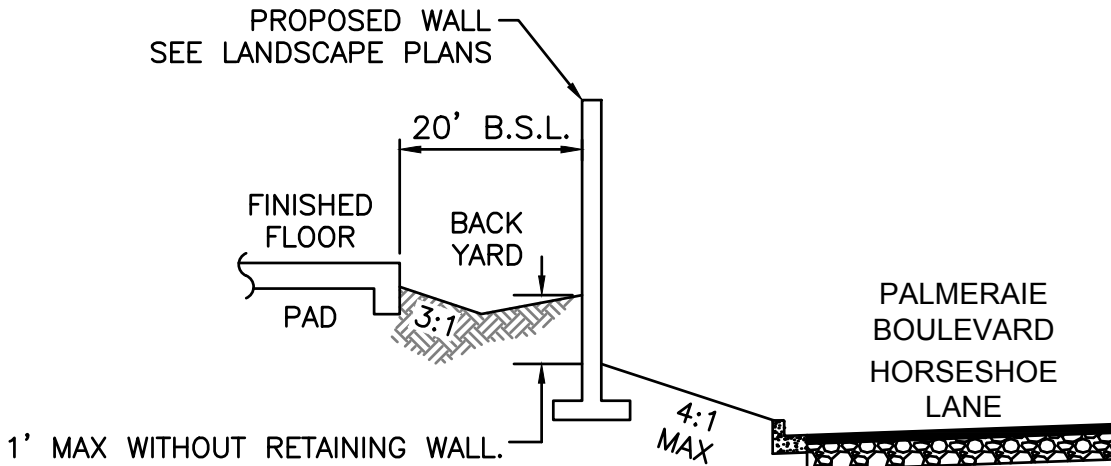

**REAR YARD TO
PALMERAIE BLVD./HORSESHOE LANE
OPTION 1**

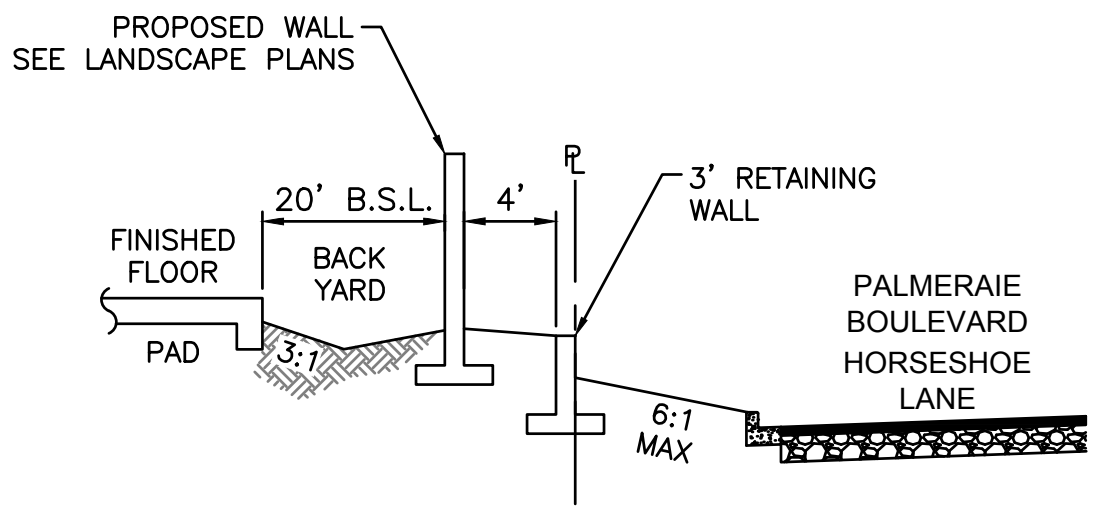

**REAR YARD TO
PALMERAIE BLVD./HORSESHOE LANE
OPTION 2**

**NOT FOR
CONSTRUCTION**

SCALE = N.T.S.	RITZ - PARCEL C	 CELEBRATING 60 YEARS
EXHIBIT		
4550 North 12th Street Phoenix, Arizona 85014 Phone 602-264-6831 http://www.cvlci.com	GRADING SECTIONS	3 OF 3

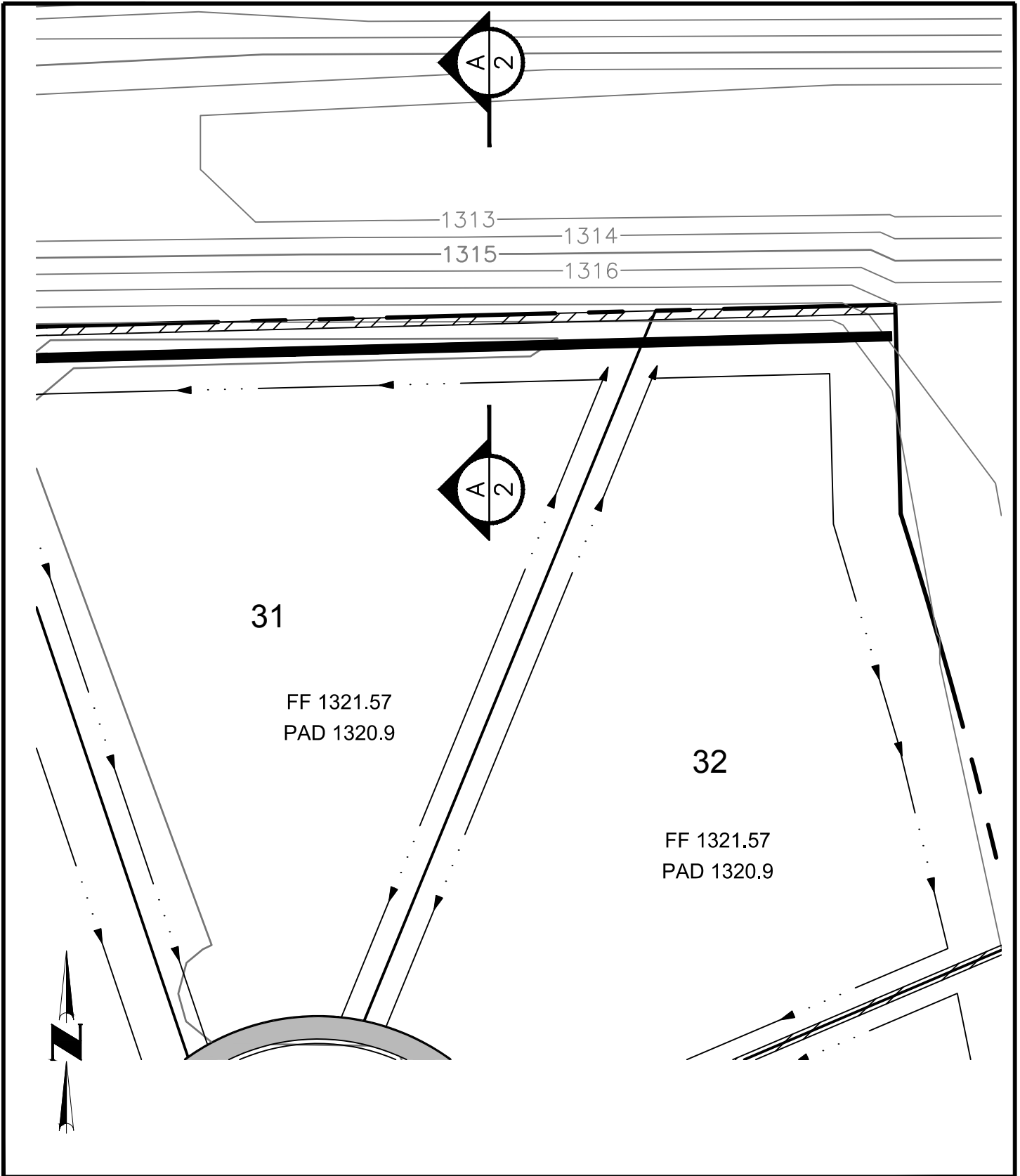

SCALE 1" = 30'
 EXHIBIT
 4550 North 12th Street
 Phoenix, Arizona 85014
 Phone 602-264-6831
<http://www.cvlci.com>

RITZ - PARCEL C

RETAINING WALL EXHIBIT

1 OF 2

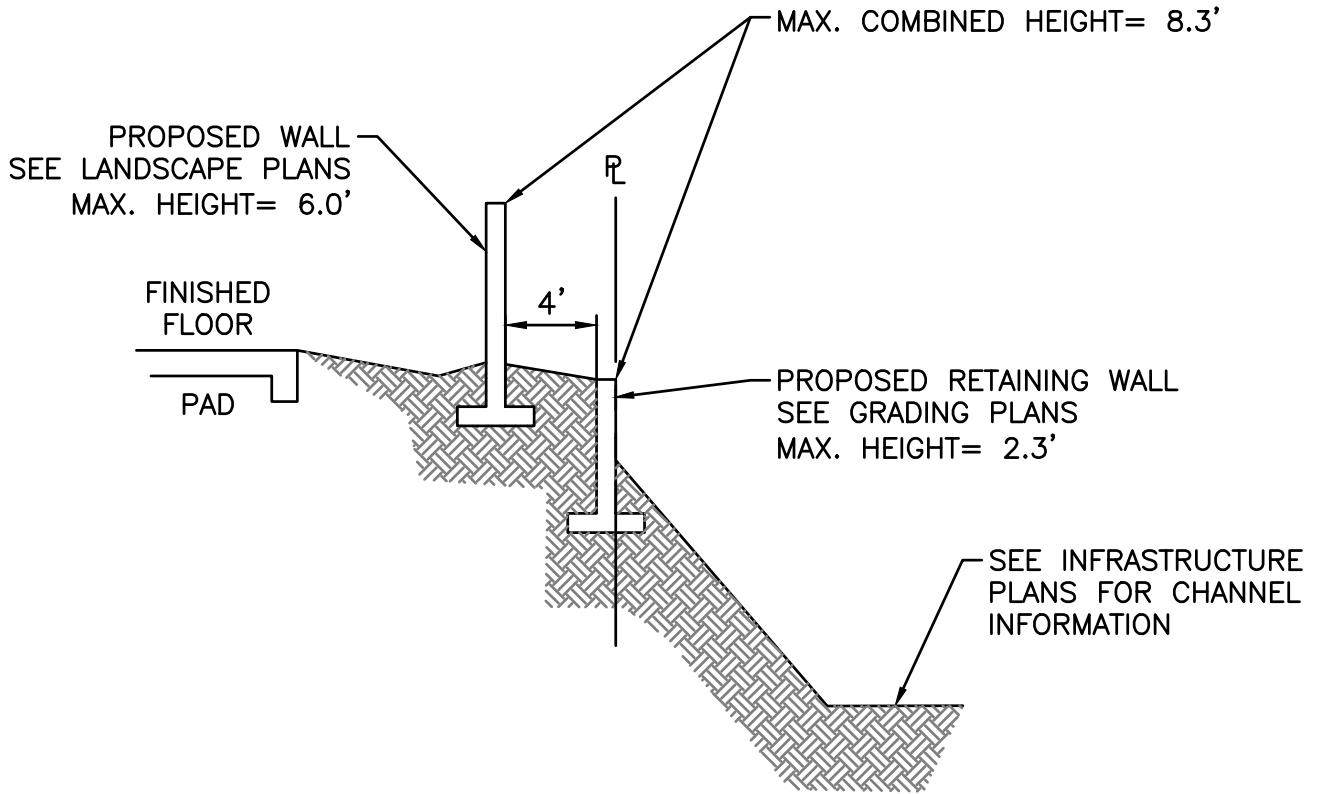

SECTION A-A
N.T.S.

SCALE = N.T.S.	RITZ - PARCEL C	 CELEBRATING 60 YEARS
EXHIBIT		
4550 North 12th Street Phoenix, Arizona 85014 Phone 602-264-6831 http://www.cvlci.com	RETAINING WALL EXHIBIT	2 OF 2