

**ORDINANCE NUMBER 2018-08**

**AN ORDINANCE OF THE TOWN OF PARADISE VALLEY,  
ARIZONA AMENDING THE PARADISE VALLEY ZONING  
ORDINANCE, Article XXII, HILLSIDE DEVELOPMENT  
REGULATIONS AND CHAPTER 5 OF THE TOWN CODE,  
BUILDING AND CONSTRUCTION**

**BE IT ORDAINED BY THE MAYOR AND TOWN COUNCIL OF THE TOWN OF  
PARADISE VALLEY, ARIZONA:**

Section 1. Article XXII, Hillside Development Regulations, Section 2200- 2209, are hereby amended (with deletions shown as ~~strikethroughs~~ and additions shown in **bold type**):

**Article XXII. HILLSIDE DEVELOPMENT REGULATIONS** <sup>110 112 181 193 194 409 425 533 558</sup>  
654580

**Section 2200. INTRODUCTION**

As valuable scenic resources, Camelback Mountain, Mummy Mountain and the Phoenix Mountains provide a permanent visual presence that exemplifies what is unique about Paradise Valley. They define the location and character of the Town, shape our sense of place and contribute to the Town's identity. These land forms, their foothills, and other areas over a 10% slope, offer a desirable setting visible to the entire metropolitan area and an intrinsic aesthetic value to the Town; therefore they require unique standards resulting from the characteristics of hillside terrain.

**Section 2201. PURPOSE**

- I.** This article exists to establish provisions to: a) regulate the intensity of development; b) preserve and protect the hillside environment; c) provide for the safety and welfare of the Town and its residents; and d) establish rules and procedures for review by the Hillside Building Committee for hillside development, building and construction plans through the implementation of the following:
1. Require building massing to adapt to the natural hillside topography thereby reducing the scarring effects of roads, drives, Building Pads and Cut and Fill slopes.
  2. Encourage all improvements to be designed and constructed in a manner that minimizes the impact of Development from viewpoints on the valley floor and adjacent slopes.

3. Prevent unnecessary Grading or stripping of vegetation, preserve drainage patterns, protect the public from natural hazards of storm water runoff and erosion, and require re-vegetation in order to maintain the natural landscape environment.
  4. Preserve visual open space, unique natural features, wildlife habitats and retain the integrity and natural states of the identified dominant peaks and ridges.
  5. Provide Development and construction practices and methods to ensure greater fire protection in hillside Development areas.
  6. Require limited and efficient use of exterior lighting to maintain minimal night-time lighting levels and preservation of the dark sky.
- II.** Conservation Easements. Hillside property owners are encouraged to donate a “conservation easement area.” A property owner may dedicate all or a portion of the undeveloped property as conservation easement area in order to preserve and protect the hillside environments. Development will be prohibited in the conservation easement area; however, areas in the easement can be used for “land use rights” (including, but not limited to, floor area ratio calculations, setback measurements, disturbance area, and other uses). Actual construction on, access to, or rights to occupy the conservation easement area would not be allowed on the conservation easement area.

This Article endeavors to enhance design quality so that the resulting Development maintains the essential natural characteristic and context of the hillside consistent with the goals and policies of the Town's General Plan.

FIGURE 1 – HILLSIDE DEVELOPMENT AREA

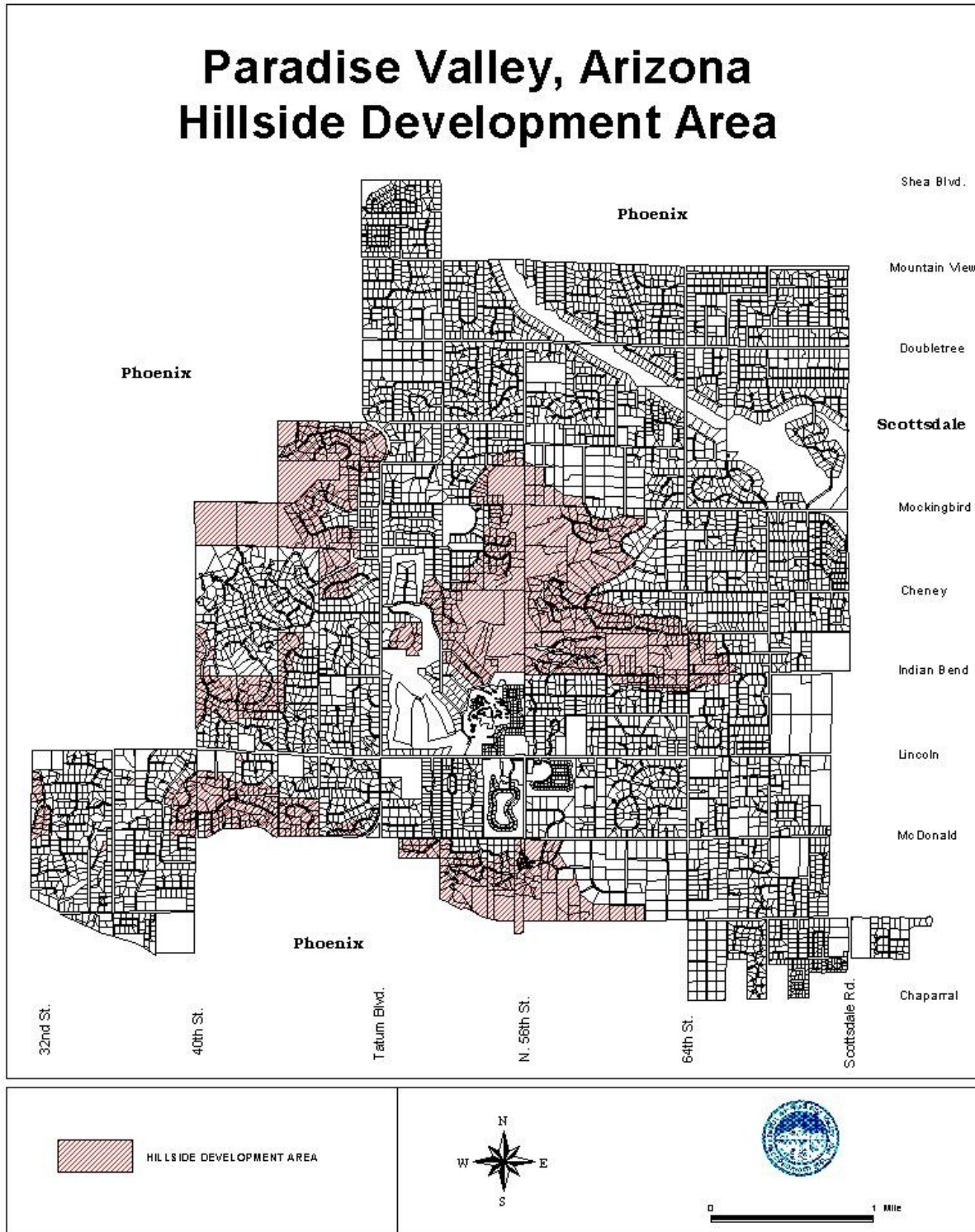

**Section 2202. IMPLEMENTATION**

The provisions of this Article shall apply to all land within a Hillside Development Area as denoted on **FIGURE 1 – HILLSIDE DEVELOPMENT AREA** and to all lands where the natural terrain under the Building Pad has a slope of ten percent (10%) or greater (see example below in Figure 2), whether shown in Figure 1 or not. However, a 10% or greater slope, in an area not denoted on Figure 1, created by a natural wash on land that would otherwise not be classified as hillside land, shall be exempt from the hillside regulations. Hillside lands are also subject to special provisions relating to Lot split and subdivision development as set forth in the subdivision code. If there is a conflict between the Hillside Development provisions and another section of this Ordinance or the Town Code, these provisions shall prevail.

**FIGURE 2 –10% SLOPE**

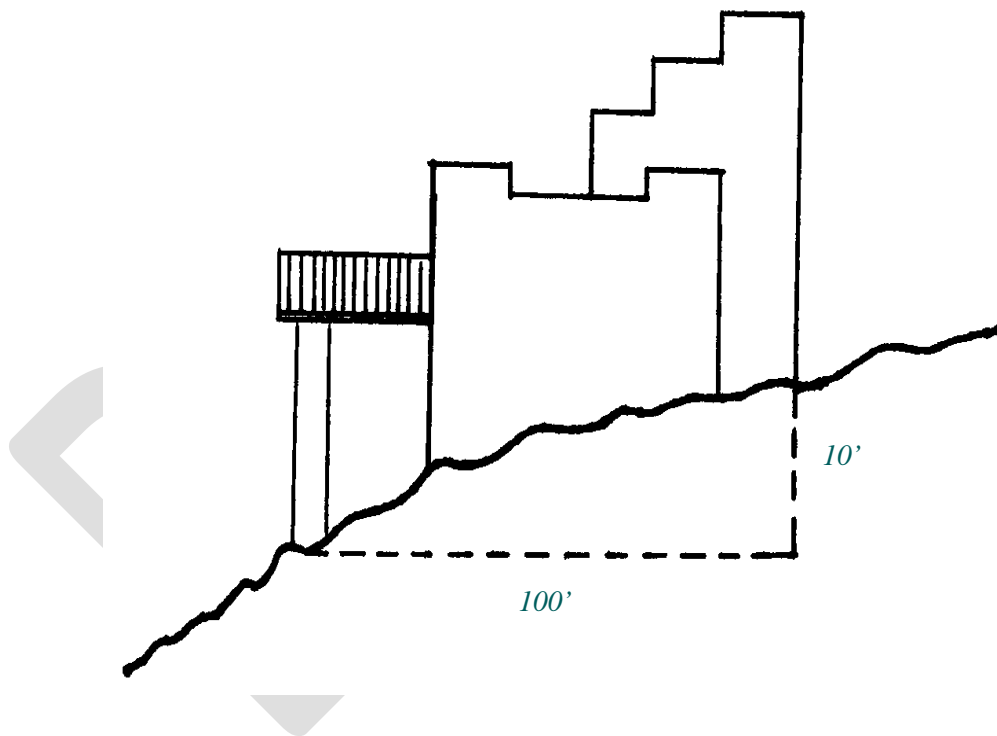

**Section 2203**      **HILLSIDE DEFINITIONS.** Where definitions are not defined in this section, the definitions in Article II shall control. For purposes of this Article, the terms contained in the Article shall have the following meanings:

Acre - 43,560 square feet as measured on the horizontal plane.

Alter the Mountain Top Ridge Line –Any Development on the Primary Ridge Line shown on **FIGURE 3** that disturbs or alters the natural mountain top profile.

Applicant – The person or entity desiring to improve or otherwise engage in any Development of property in the Hillside Development Area, including the owner of the property and any agents acting on behalf of the owner.

Boulders - A rock fragment that has been detached from a bedrock mass whose size in the least dimension is 10 inches.

Building Pad – The total area under roof of all structures proposed for the property.

Building Pad Slope - The percent of slope measured at right angles to the natural contours along a line passing through the center of the proposed building and terminating at the ends of the Disturbed Area limits of the Building Site.

Building Site - That portion of the Lot or parcel, excluding driveways, upon which a building and appurtenances are to be placed or are already existing, including but not limited to; adequate areas for parking, turnaround areas not separated by driveways, sewage disposal, clearance, and proper drainage which conforms to the requirements of the provisions of this Article and the Town Code.

Cantilever – A rigid structural element of a building, deck, or walking surface that is anchored at one end of a support from which it protrudes ~~greater~~ more than two feet. This excludes roof overhangs that do not have a walking surface above them.

Code - The Code of Ordinances of the Town of Paradise Valley, Arizona in effect as of the date of these Regulations and as may be amended.

Commission - The Planning and Zoning Commission of the Town of Paradise Valley.

Committee - The Hillside Building Committee of the Town of Paradise Valley.

Conservation - Retention or acquisition of land for the purpose of preservation in a natural state.

Conservation Easement - A permanent open space easement granted to the Town or to a public land trust to prohibit Development of property including roads and utilities and to retain and preserve the land for the scenic enjoyment of the general public.

Council - The Town Council of the Town of Paradise Valley.

Cut - The land surface which is shaped through the removal of soil, rock, or other materials.

Development - Any Grading, excavation or construction.

Disturbed Area - That area of natural ground excluding the Footprint of the residence that has been or is proposed to be altered through Grading, Cut and Fill, removal of natural vegetation, placement of material, trenching, or by any means that causes a change in the undisturbed natural surface of the land or natural vegetation (Please reference Section 2207.III).

Driveway – A paved or unpaved area providing access to the property, located between the right-of-way and the parking area or garage of the property.

Fill - The deposit of soil, rock, or other materials placed by man.

Finished Grade - The final grade and elevation of the ground surface after Grading is completed.

Footprint - That area of the residence measured from the outside walls (excluding any overhanging portions) which includes indoor uses such as attached garage, carports, utility room, laundry, etc., but excludes outdoor uses such as patios and breezeways.

Grading - Any excavating, or filling or combination thereof, including the conditions resulting from any excavation or Fill.

Hillside Development Area - Those areas marked in **FIGURE 1** and to all lands where the natural terrain under the building pad has a slope of ten percent (10%) or greater, whether shown in FIGURE 1 or not. However, a 10% or greater slope, in an area not denoted on Figure 1, created by a natural wash on land that otherwise would not be classified as hillside land shall be exempt from the hillside regulations.

Hillside Wash – A Natural watercourse at least two feet deep from the top of the bank and measuring at least five feet wide at the top of the bank.

Lot - A legally subdivided parcel of land occupied or intended for occupancy by one main building, together with any accessory buildings including the open spaces required of the Hillside Regulations and having adequate frontage on a public or private street.

Natural Grade - The undisturbed natural surface of the land, including washes.

Off-Site Storm Water – Water that originates during precipitation events that comes from other parcels and flows onto the subject Lot.

On-Site Storm Water - Water that originates during precipitation events that falls directly onto the subject Lot.

Primary Ridge Line - That line running from the highest point along the mountain top downward along a divide to the 1500 foot mean sea level elevation as shown on **FIGURE 3**.

Raised Outdoor Living Area – Uncovered areas such as porches, decks, platforms, and retained areas which extend three (3) feet or more above grade.

Retaining Wall - A wall or terraced combination of walls, including, planters, negative edge pools, used solely to retain more than eighteen inches (18") of material, water, or to support or to provide a foundation or wall for a building.

Raw Spill Slope – An area created by causing or allowing earth or other material to fall, flow or run down the slope, thereby creating a change in the natural appearance and topography.

Sheet Flow – A shallow and wide overland flow of water.

Significant Natural Features - Include Hillside Washes, Significant Vegetation, and Significant Rock Outcroppings provided these features are in their undisturbed natural state.

Significant Rock Outcroppings - Any surface rock or group formation of rocks covering an area of 200 square feet or larger or any surface rock formation with a height greater than ten feet from the lowest surrounding grade.

Significant Vegetation - A living single tree or cactus having a height greater than 15 feet or three or more trees or cacti, located within a radius of 15 feet, each having a height greater than 12 feet.

Steep Slopes – Slopes 20% or greater within a 200' radius of the proposed Building Site.

Subsurface or Seismic Damage - Knowledge of subsurface or seismic damage that may have resulted from adjacent or previous development and should be verified through seismic refraction survey.

Subterranean - That space which lies totally underground, and which cannot be seen from outside the exterior perimeter of the structure on the same horizontal plane which originates at that point where the building intersects the ground.

Town - The Town of Paradise Valley.

Unique Topography - Non-uniform grades throughout the lot.

Veneered Rock Slope – A group formation of rocks of similar colors that blend in with the surrounding natural setting.

View Fencing (View Fence) – Fencing that is constructed in such a manner as to achieve ~~70~~ 80% overall openness.



**FIGURE 3 – PRIMARY RIDGE LINE DESIGNATION**

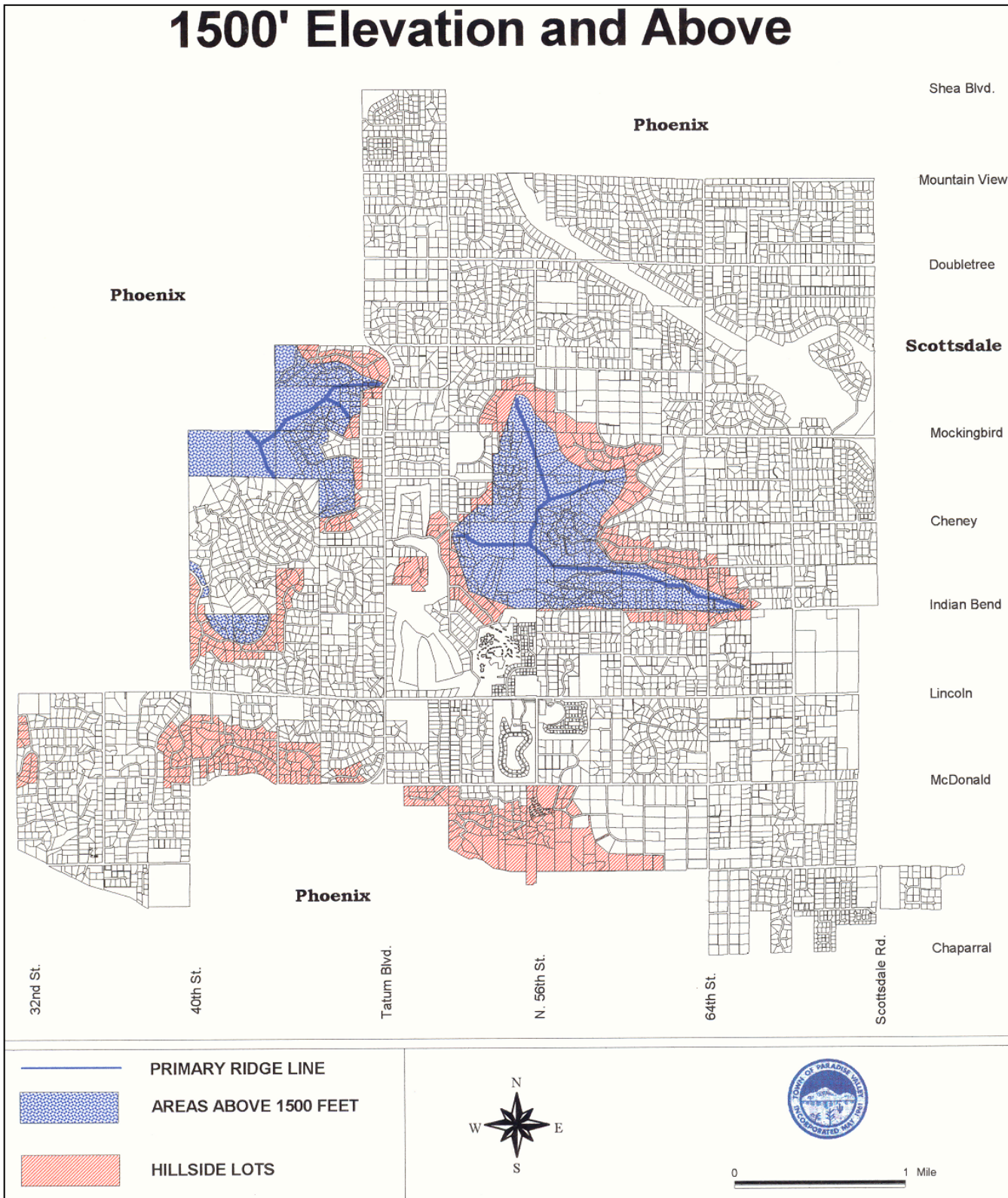



**Section 2204 HILLSIDE BUILDING COMMITTEE.**

- A. The Hillside Building Committee or Hillside Building Committee Chair as established in Chapter 2 of the Town Code shall review all new applications submitted to the Town for Development and related construction within a Hillside Development Area. No building permit shall be issued for such application until approved by the Committee and then such issuance shall only be in accordance with the plans and specifications approved by the Committee.
- B. The Hillside Building Committee may review applications for additions to existing structures in accordance with Section 2207 (VII)(A) of this Ordinance.
- C. The Hillside Building Committee may review applications for accessory construction (e.g. fences, Retaining Walls, pools etc.) if the Town Manager or designee, in consultation with the Hillside Building Committee Chair, determines that the proposed construction creates a significant visual impact or proposes an additional disturbance area.
- D. The Hillside Building Committee approval process may consist of the following stages:
  - 1. An Administrative Hillside Chair Review.
  - 2. A Combined Hillside Building Committee Review Meeting.
  - 3. A Conceptual Plan Review Meeting.
  - 4. A Formal Hillside Building Committee Review Meeting.

**Section 2205 REVIEW AND DEVELOPMENT PROCESS.** The Hillside Building Committee shall review Development plans, as outlined in Section 2204, prior to the issuance of a building, Grading or other Development permit. The review and development process consists of up to four stages, depending upon the nature and scope of the proposed Development. In addition, safety reviews and measures may be required as outlined in Section 2205.V.

- I. Administrative Hillside Chair Review: The Applicant shall submit a completed application and the required fees to the Town. Proposed accessory structures and additions may be reviewed by the Hillside Building Committee Chair provided the proposed improvements do not: (i) exceed or increase the building height of the main residence greater than six(6) feet; (ii) increase the existing building Footprint by more than 100 square feet; (iii) create more than 100 square feet of additional Disturbed Area; (iv) increase the length of walls by more than 15 lineal feet; (v) propose a significant addition of exterior lighting; or (vi) create a significant adverse visual impact. The Chair shall review the submittal for compliance with the goals, purposes, and specific criteria of this ordinance.
- II. Combined Hillside Committee Review Meeting: The Applicant shall submit all materials outlined in Section 2206 (III) to the Town. The Hillside Building Committee shall then review the submittal for compliance with the goals, purposes, and specific criteria of this ordinance and either approve, approve with stipulations or changes, or deny the

submittal. ~~Average~~ Minor remodel/additions, site improvements (such as, but not limited to, solar panels, pool and spa additions), shall be reviewed as a Combined Hillside Committee Review.

- III. Concept Plan Review Meeting: The Applicant, along with their architect and engineer shall submit a completed application and the required fees, to the Town Manager or designee, at the time they request a concept plan review meeting (pre-hillside meeting) with the Hillside Building Committee. All new single-family residences and major remodel/additions require a Concept Plan Review Meeting. The purpose of this meeting is to discuss, review, and give suggestions and guidance to the Applicant regarding the proposed development including: the location of the building pad and accessory uses; how these relate to Significant Natural Features; the preservation of existing vegetation; Grading concepts and their adaptation to the natural hillside topography; and how the requirements pursuant to these hillside regulations and purpose statement will guide the proposed Development.
- IV. Formal Hillside Committee Review Meeting: At this stage, in addition to those materials previously submitted, the Applicant shall submit all materials outlined in Section 2206 (III) to the Town Manager or designee. The Hillside Building Committee shall then review the submittal for compliance with the goals, purposes, and specific criteria of this ordinance and either approve, approve with stipulations or changes, or deny the submittal. All new single-family residences and major remodel/additions require a Formal Hillside Committee Review Meeting.
- V. Safety Measures and Reviews. Reference Chapter 5 of the Town Code for a Safety Measure and Review Requirements.
- VI. Building Permit Review: The final construction plans submitted to the Town Community Development Department for review and approval shall comply with the final approval of the Hillside Building Committee. Any variation from excavation and Grading requirements within the Town Code must be accompanied by a soils engineering report from a testing laboratory or geological engineer approved by the Town Engineer. No site preparation or construction shall commence until the Town has issued a Grading, demolition, or building permit.
  - A. The plans, including any safety measures and reports, for any Development in the Hillside Development Area, must be approved by the Town and appropriate legal permit(s) issued before any clearing and grubbing, Grading, bulldozing, blasting, or movement of earth is commenced. Building permit application must be submitted within a twelve month period after the date of approval from the Hillside Building Committee or Hillside Building Committee Chair. If a building permit application is not submitted within a twelve month period, the approval shall be null and void. If appropriate, based upon circumstances outside the control of the Applicant, a one-time six (6) month extension may be granted by the Town Manager or designee. If the permit expires, at no time after that expiration period does the applicant have any vested prior approval rights.
  - B. When a building, demolition, or Grading Permit is required under the provisions of these regulations or any other provision of the Town Code for new single

family residences, major remodels or additions, major site improvements, and minor remodel/additions and minor site improvements, the Applicant shall first provide the Town with a form of financial assurance, and a right of entry and temporary construction easement agreement, acceptable to the Town Attorney.

The financial assurance shall be in an amount sufficient to place the Town in an assured position to do or to contract to be done the necessary work to cover, restore, and landscape exposed fills and cuts to blend with the surrounding natural terrain and to restore the property back to natural grade to the extent possible. The financial assurance shall be calculated in a dollar amount equal to thirty-five (35) times the Grading Permit Fee specified in the Town's Master Fee Schedule or in such greater amount as deemed appropriate by the Hillside Building Committee and Town Manager or designee with the Committee to evaluate a higher fee when there is demolition (with or without Cut and Fill) or the building site has loose fill or Boulders, significant washes or drainage ways, or steep and difficult to access terrain that would dictate the need for a higher assurance amount in order to complete restoration of a particularly difficult hillside property site.

The Grading Permit for new single-family residences, major remodel/additions, and major site improvements shall be based upon the total number of cubic yards of Cut and Fill needed to restore the property back to Natural Grade. The Grading Permit for minor remodel/additions and minor site improvements shall be based upon the total number of cubic yards of Cut and Fill associated with the project that is needed to restore the affected portions of the property back to Natural Grade.

In the event that work or Development on the site has commenced and then subsequently been abandoned for more than six (6) months the building, demolition, or Grading Permit shall be revoked and become void; the financial assurance shall be forfeited to the Town at that time; and the financial assurance may be used by the Town, in its discretion, in such amounts as are necessary to restore the hillside property construction site to its original condition (based upon the scope of work - new single family residence, major remodel/additions, major site improvements or minor remodel/additions and minor site improvements).

Further, in the event that at any time during building, demolition, or Grading (or other construction at the site), unhealthy or unsafe conditions arise or are created by the Applicant and are not promptly addressed or remediated so as to cure the unsafe condition, the financial assurance may be used by the Town to address any remediate , unhealthy or unsafe condition. The Applicant or property owner shall, upon reasonable notice from the Town, provide access to the property for the purpose of restoration of the construction site to its original condition (based upon the scope of work - new single-family residence, major remodel/additions, major site improvements or minor remodel/additions and minor site improvements) or to address any health or safety conditions that arise or are created by the Applicant. In the event that building, demolition, or Grading has not commenced within six months from the date of issuance of the building, demolition, or Grading Permit,

the plan approval and permit shall expire and the financial assurance shall be returned or cancelled.

VII. Issuance of Certificate of Occupancy: Prior to the issuance of any Certificate of Occupancy for any building constructed pursuant to these Regulations, the applicant shall obtain from the Town certification of compliance with this Article.

For projects that are ready for Certificate of Occupancy (C of O) or Certificate of Completion (C of C) between the months of May 15<sup>th</sup> and September 15<sup>th</sup>, the applicant may request a temporary deferment on the installation of the landscaping (in which the C of O or C of C may be released without the installation of the landscaping). The temporary landscape deferment is subject to the following conditions:

1. The landscaping shall be installed in accordance with the approved plan,
2. The Town will hold the Financial Assurance until the landscaping is installed, and
3. The landscaping must receive an approved inspection by the Town within five (5) months from the issuance of the C of O or C of C.

**Section 2206**      **DOCUMENTARY REQUIREMENTS AND CERTIFICATION** <sup>558 580</sup>

- I.      **ADMINISTRATIVE HILLSIDE CHAIR REVIEW.** The applicant shall submit plans and documents based upon the scope of the improvement and as determined by the Town Manager or Designee and the Hillside Committee Chair.
  
- II.     **CONCEPT PLAN REVIEW MEETING.** The applicant shall submit the following:
  - A.      **Notification Letters.** At least three (3) weeks prior to the scheduled conceptual Hillside Building Committee meeting the applicant shall submit to the Town a neighbor notification letter complete with address labels, with appropriate postage, for all property owners within 1,500 feet of the perimeter of the subject property. This notification letter shall include the following information; a) type of proposed development (addition, remodel, new construction), b) the scheduled hearing date and time, c) that the letter is only a courtesy notification and that their attendance at the meeting is not required. d) the purpose of the meeting, and e) the goals of the meeting.
  - B.      Seven (7) copies of a preliminary site plan that includes, but is not limited to, the building Footprint, Driveway, swimming pool, and accessory use locations along with topographic information for the Lot.
  - C.      A 3-dimensional representation of the general massing of all proposed structures (e.g. a mass model, a 3-D scaled rendering or a scaled computer-generated model in relation to topography – not a detail model).
  - D.      A recent aerial photo of the site (less than 1 year old), with topography, Lot lines, and the building Footprint superimposed on it, identification of Significant Natural Features, as well as adjacent Lots and structures within 100 feet of the perimeter of the subject property (minimum 24"X 36"), and the location of the Driveway access in relation to the nearest roadway.
  - E.      Preliminary calculations on land disturbance and Cut and Fill methods.
  
- III.    **FORMAL AND COMBINED HILLSIDE COMMITTEE REVIEW MEETING.** All plans submitted to the Town for review shall be stamped and sealed by the appropriate registered or licensed professional (e.g. civil engineer, land surveyor, geologist, architect). All plans shall be reviewed by the Hillside Building Committee. In addition, once the plans have been approved by the Committee the applicant shall submit final plans, in accordance with the Hillside Building Committee's approved plans, to the Community Development Department for review. Plan review fees for each such submittal shall be paid at the time of the submittal of such plans in the amount specified in the Town of Paradise Valley fee schedule, as such may be amended from time to time. The following plans and material shall be required:
  - A.      **Notification Letters.** At least three (3) weeks prior to the scheduled Formal Hillside Building Committee Meeting the applicant shall submit to the Town a neighbor notification letter complete with address labels, with appropriate

postage, for all property owners within 1,500 feet of the perimeter of the subject property. This notification letter shall include the following information; a) type of proposed development (addition, remodel, new construction), b) the scheduled hearing date and time, c) that the letter is only a courtesy notification and that their attendance at the meeting is not required, d) the purpose of the meeting, and e) the goals of the meeting.

- B. Seismic Refraction Survey. Unless waived by the Town Manager or designee, all proposed Cuts shall require a seismic refraction survey, performed by a registered geologist or registered geotechnical engineer. If the geological report, geotechnical report, or seismic refraction survey indicates fractured or unstable rock, then the proposed location of the Building Site (or appurtenances) shall be changed to a stable location unless the unstable condition(s) can be mitigated by an engineered design that creates a stable location and complies with the provisions of this Article and other Articles of this Zoning Ordinance. The geological report and results of the seismic refraction survey shall be submitted to the Town.
- C. Site Plan. A detailed site plan (minimum 24" X 36"), sealed by a registered engineer or land surveyor, with topographic information for the entire Lot including under the Footprint of the building. This site plan shall depict: the limits of disturbance; the building envelope including the building Footprint, Driveway(s), swimming pools, mechanical equipment, sanitary sewer or septic systems; location, size and type of mechanical screen walls and pool barrier fencing; length and height of Retaining Walls; all accessory buildings; and Significant Natural Features.
- D. Photographs. Photographs of the site looking out from the property in all directions and of the property from several different views.
- E. Grading and Drainage. A detailed Grading, drainage plan (minimum 24" X 36"), and on-site retention, sealed by a registered civil engineer, with topographic information for the entire Lot. This plan shall show proposed finished contours at 1-foot intervals within a perimeter of 20 feet from the building, a maximum 2 foot intervals elsewhere, and shall show existing and proposed contours. This plan shall show the limits of excavation and Fill; slope of Cut and Fill; total cubic yards of excavation and Fill; method of concealment for each Fill or exposed Cut; and the calculations for the amount of disturbance for the total development. This plan shall show original drainage pattern (natural course) and proposed changes. If any structures or culverts are involved, it will be necessary to include an estimate of peak flows for a 100-year 2-hour frequency storm event to establish drainage facility cross-sections. The plan shall show the type and location of on-site storm water retention and the retention volume for each location.
- F. Landscaping. A detailed landscape plan that includes, but is not limited to the following: the building envelope; building Footprint; all accessory structures and locations; all Significant Natural Features; plant materials list with type, quantity and size; plant location; location and species of salvaged plant materials; and methods for re-vegetation of all Disturbed Areas. Native desert vegetation shall



be identified and preserved to the maximum extent reasonably possible. A landscape salvage plan shall be provided.

- G. Cross Sections. Cross sections of new buildings and appurtenances at a scale equal to or greater than the site plan scale at three or more locations perpendicular to the contours through the Building Site shall be clearly shown on the topographic map and sealed by a registered professional, or other professionals as determined by the Town Manager or designee.
- H. Lighting. A detailed outdoor lighting plan indicating the proposed luminaire locations on the building and on the site (if applicable); the type of illuminating devices including; the manufacturer's catalog cut sheets and drawings; and photometrics that describe the illuminating devices; the fixtures, lamps, lumens, supports, beam angles, and other devices.
- I. 3-Dimensional (3D) Scaled Computer Model or a 3D Scaled Study Model: The applicant shall submit a 3D computer model or a scaled study model for Hillside Building Committee review.
  - a. **3D Computer Model: A computer generated 3D model, with accurate points of reference superimposed on it; showing the appearance of the building, Lot, landscaping, and skyline. The model must accurately represent the massing of all structures and roof forms as well as the following:**
    - i. All windows, exterior doors and skylights.
    - ii. A sufficient area of the property to visually relate the proposed structure and accessory uses to the natural terrain.
    - iii. The location of the Driveway access in relation to the nearest roadway.
  - b. 3D Scaled Study Model: Including all proposed improvements, at not less than (1/16) inch = (1) foot showing the relationship of all proposed improvements to the contours of the Lot. The model must accurately represent the massing of all structures and roof forms as well as the following:

All windows, exterior doors, and skylights (showing the location of all proposed skylights and their orientation to neighboring properties), and the location of the Driveway access in relation to the nearest roadway.

1. The model shall include enough of the property to visually relate the proposed structure and accessory uses to the natural terrain.
2. The Applicant's name, architect's name, builder's name, Lot number, scale, and north arrow.

- J. Rendering. An accurate oblique view architectural rendering in color or a computer generated 3-dimensional picture shall be submitted showing the appearance of the building, Lot, landscaping, and skyline. The rendering or computer-generated picture, and the model may remain in the custody of the Town until a Certificate of Occupancy is issued or until released by the Town.
- K. Exterior Material Samples: Include samples of all colors, materials, and material specifications mounted on rigid board with all materials identified with the manufacture's name, color, and LRV number where applicable. Material samples or color specifications are required for all exterior materials and finishes including but not limited to:
- Roof
  - Metal
  - Hardscape
  - Stone
  - View fencing
  - Wall color and texture (8½" x 11" sample size)
  - Masonry
  - Glass
  - Driveway and terrace paving
  - Garage doors
  - Patio, deck area including second story structures, pool, and breezeways
- L. The Applicant's Engineer or Surveyor shall install a marker to designate the location of the house at the major building corners. The markers should be at least 3 feet in height with a colored ribbon at the top of the marker. The applicant shall install markers at least two (2) weeks prior to the Formal Hillside Committee meeting and remove immediately following the Formal Hillside Committee meeting.

**Section 2207**      **DEVELOPMENT STANDARDS** <sup>558 654</sup>

**I. MOUNTAIN PROFILE INVIOATE**

- A.      At and above an elevation of 1500 feet mean sea level, no Development shall occur which will Alter the Mountain Top Ridge Lines as shown on **FIGURE 3** . A model must be submitted pursuant to Section 2206 III (I) showing compliance with this paragraph together with complete plans showing the appearance of the mountain top profile, as part of the submittal for the Formal or Combined Hillside Committee Review. Further, no structure may extend above a plane that originates on the Primary Ridge Line and angles downward from the Primary Ridge Line by twenty degrees (See **FIGURE 4**).

**FIGURE 4 – RIDGE LINE TWENTY DEGREE DELINEATION**

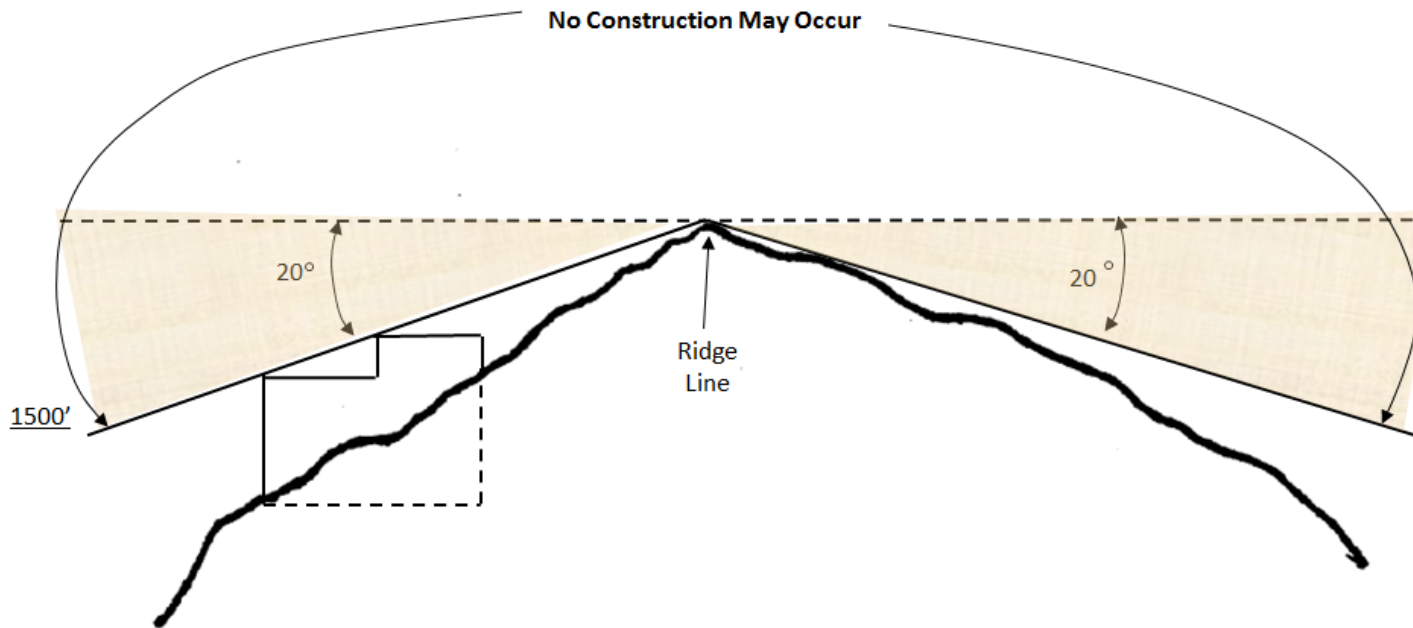

**II. ARCHITECTURAL STANDARDS.**

A. For development within the Hillside Development Areas, the height of structures shall be determined by the following four (4) sub-sections and not by the zoning district regulations that apply to Lots or parcels outside the Hillside Development Area.

1. Primary Building

- a. The height of a primary building or primary structure is limited to a twenty-four (24) foot imaginary plane that parallels the existing pre-development Natural Grade. (see **FIGURE 5**).
- b. In the case where the Natural Grade has been Cut and is not restored back against the building, no exposed face in any vertical plane shall exceed a twenty-four (24') foot height measured from the lowest, Finished Grade. The maximum height of any deck support shall not exceed twelve (12') feet tall measured from the adjoining grade.

2. Accessory Structures

- a. The height of an accessory building or accessory structure is limited to a sixteen foot (16') imaginary plane that parallels the existing pre-development Natural Grade. (see **FIGURE 5a**)
- b. In the case where the Natural Grade has been Cut and is not restored back against the building, no exposed face in any vertical plane shall exceed a sixteen (16') foot height measured from the lowest, Finished Grade. The maximum height of any deck support shall not exceed twelve (12') feet tall measured from the adjoining grade.

**FIGURE 5 – BUILDING HEIGHT IN HILLSIDE**

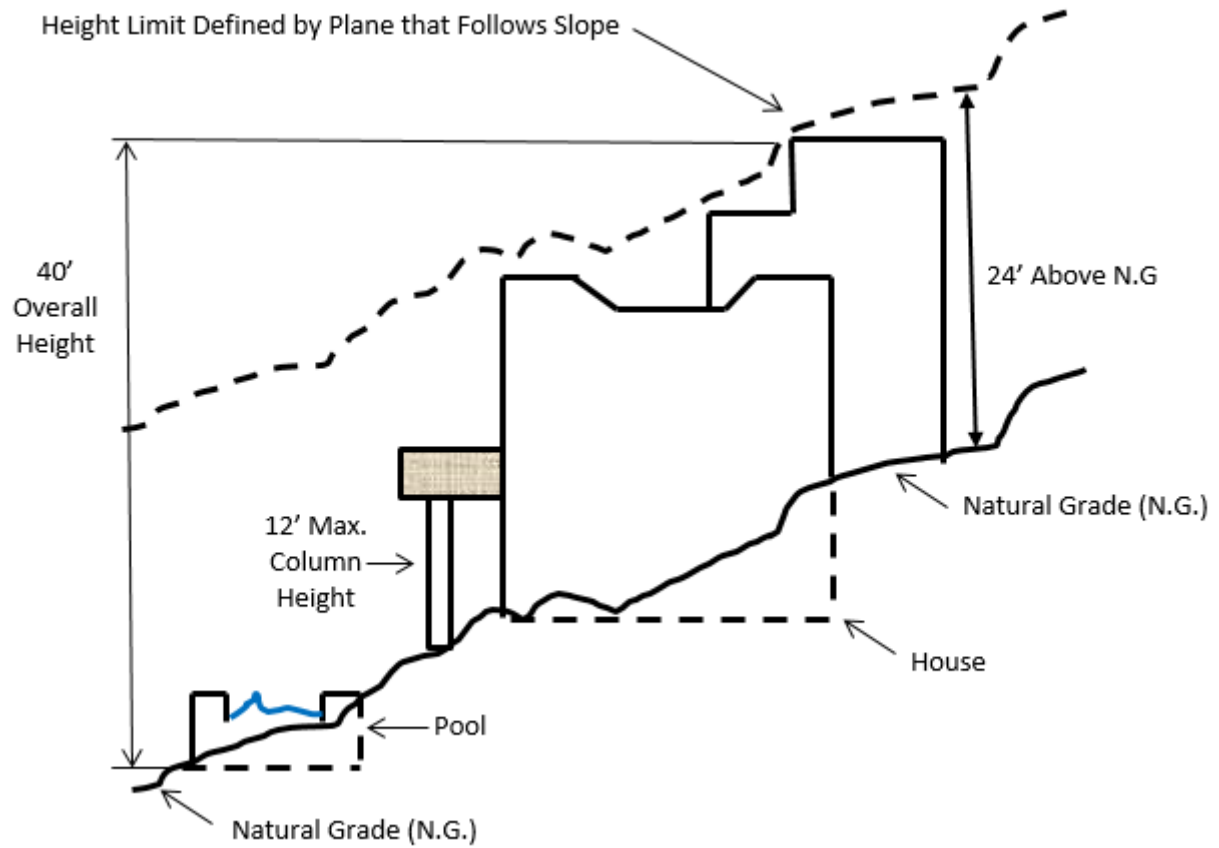
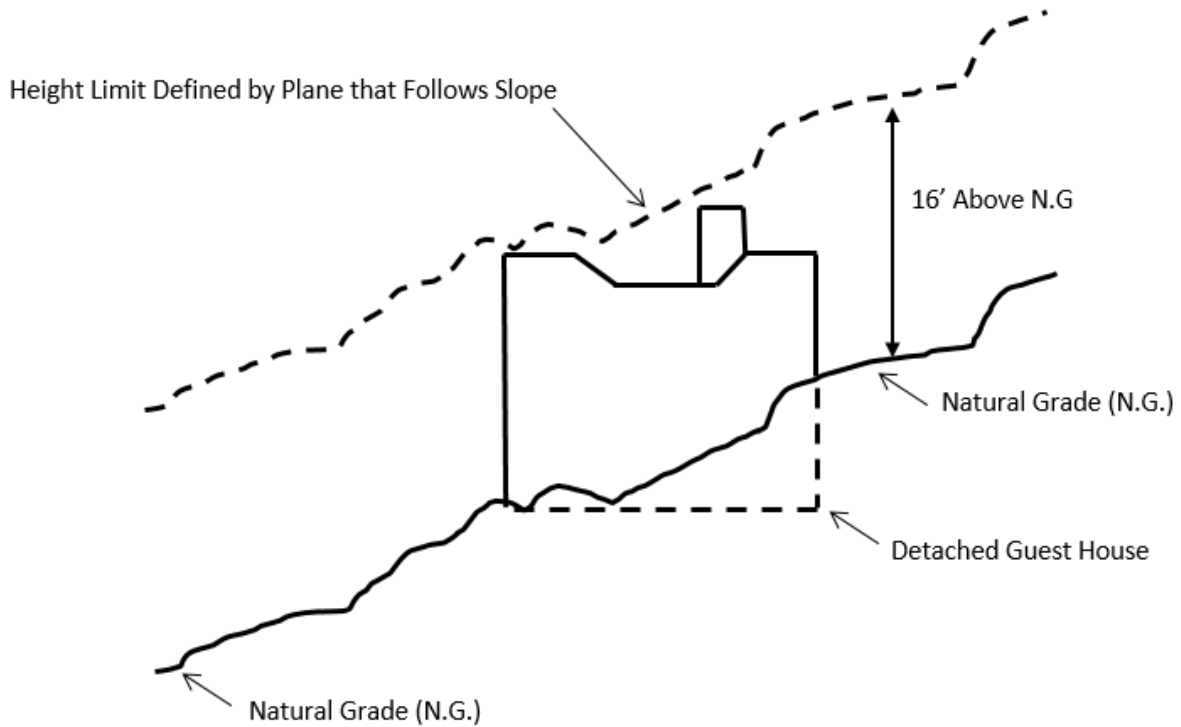

FIGURE 5A – ACCESSORY BUILDING HEIGHT LIMIT



3. The maximum overall height of the building or structure, including chimneys and accessory buildings, shall not exceed forty (40) feet from the highest point of of a building or structure to the lowest point of Natural Grade at the lowest building or structure (excluding Driveway Retaining Walls, Driveway Entry Gates, and Retaining Walls needed to prevent erosion or flooding in Accordance with Section 2207.VI) -see **FIGURE 5**).



**FIGURE 5 – BUILDING HEIGHT IN HILLSIDE**

4. Where a building spans a wash the maximum height of twenty-four (24') feet shall be measured vertically from that point where the visible structure and the side of the wash intersect. See-**FIGURE 6**.

**FIGURE 6 – BUILDING HEIGHT WITH A HILLSIDE WASH CROSS SECTION**

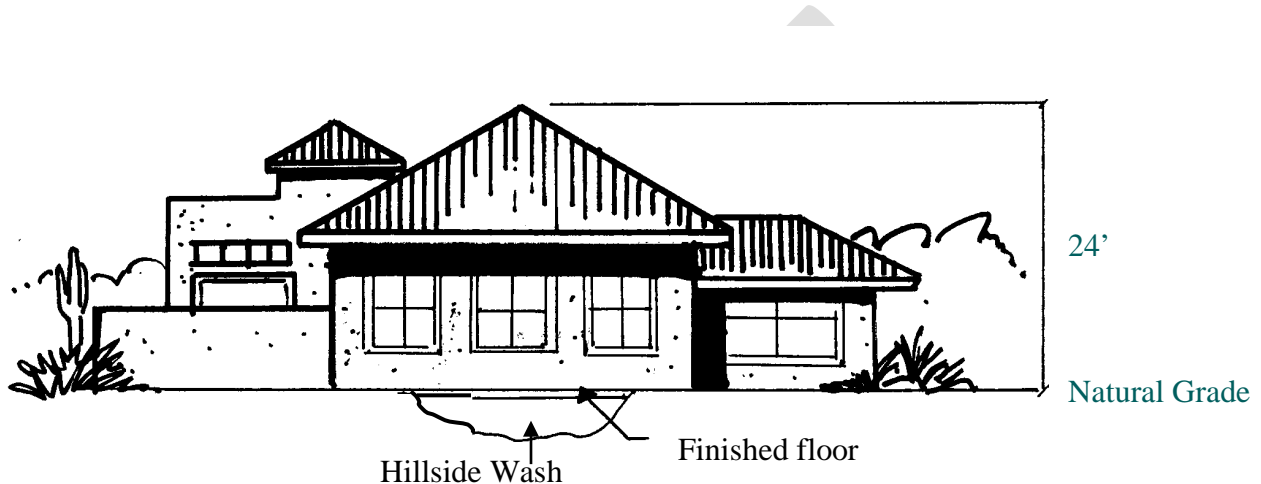

- B. Cantilevers. The primary residence, accessory buildings, and other structures (such as pool decks) may employ the use of Cantilevers, subject to the following limitations:
1. Primary residence and accessory buildings. Cantilevered elements of the building must comply with the applicable setbacks and heights of the building. Buildings employing the use of a Cantilever may extend the cantilever a maximum horizontal length of 4 feet and a maximum vertical height of 8 feet from adjoining grade. All of the area above the Cantilevered element shall be calculated as floor area and shall be included in the floor area ratio. All of the area underneath the Cantilevered element shall be calculated as Disturbed Area and shall be included in the Disturbed Area calculation (See FIGURE 7).
  2. All other structures (such as pool decks). Cantilevered elements of the structure must comply with the applicable setbacks and heights of the structure. Structures employing the use of a Cantilever may extend the Cantilever a maximum horizontal length of 4 feet and a maximum vertical height of 8 feet from adjoining grade. All of the area underneath the Cantilevered element shall be calculated as Disturbed Area and shall be included in the Disturbed Area calculation (See FIGURE 7).
  3. The visible area under a Cantilever must be finished with colors or materials that match the adjoining structures or blend in with the surrounding natural setting. The materials or colors used shall not have a LRV (Light Reflective Value) greater than thirty-eight (38) percent.
  4. Driveways. Cantilevered Driveways shall not be allowed.  
. (See **FIGURE 7** below).

**FIGURE 7 - HEIGHT FOR A CANTILEVERED ELEMENT**

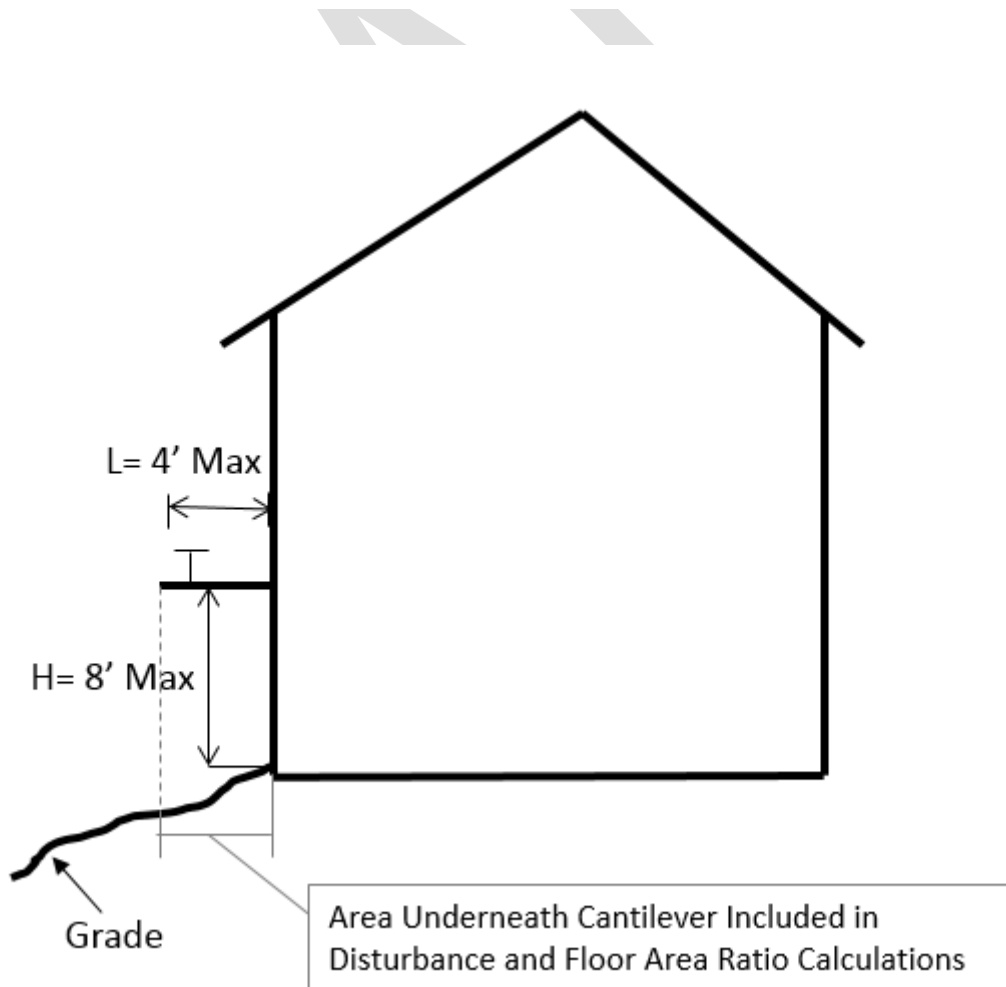
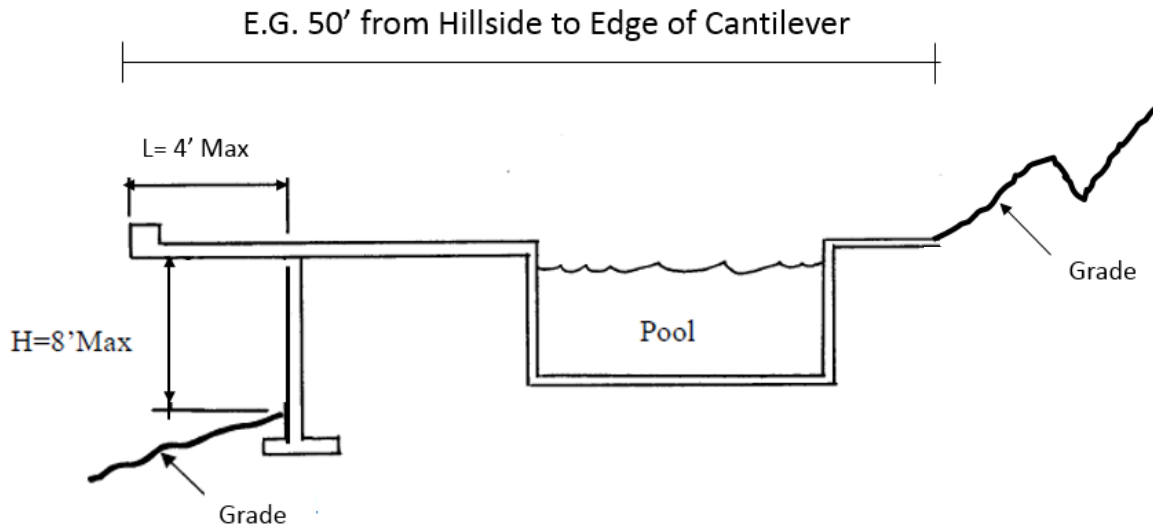

5. All of the setback requirements of the underlying zoning district shall apply in the Hillside Development Area (see Article X).
- C. Raised Outdoor Living Areas are subject to the setback requirement of pools and spas and are limited to a maximum height of eight (8') feet tall.
- D. Materials used for exterior surfaces such as structures, walls, roofs and fences shall blend with the surrounding natural setting and avoid high contrasts. There shall be no paint or material colors used which have a LRV (Light Reflecting Value) greater than thirty-eight (38) percent. Materials and color used for exterior surfaces are subject to Hillside Building Committee review and approval. The applicant must demonstrate how the materials and colors used for the exterior surfaces blend in with the natural surroundings and settings. Limited use of contrasting accent colors (in excess of 38% LRV) for small elements, including, but not limited to items such as doors and window mullions, may be allowed upon explicit approval of the Hillside Building Committee.
- E. All electrical service equipment and subpanels and all mechanical equipment including, but not limited to, air conditioning, evaporative cooling, and antennas greater than 24" inch by 36 inch oval shall not be allowed on the roof.

Solar panels may be allowed if they are integrated into the building design and hidden from view when viewed from the same or a lower elevation and approved by the Hillside Building Committee by a Combined Review. Solar panels may be allowed on pitched roofs when screened from the same or a lower elevation by the adjoining hillside or hillside Cut and approved by the Hillside Building Committee by a Combined Review.

Stealth solar technology may also be used on roofs and may not be required to be hidden from view. Stealth solar technology shall be limited to solar shingles and solar tiles that are integrated to blend in with the building design, do not have a shiny metallic finish, have a light reflective value of 38% or less, and must be approved by the Hillside Building Committee by a Combined Review.

All mechanical, electrical, and natural gas equipment along with pool equipment and antennas shall be screened in such a manner that they are not visible from outside the property when viewed from the same or a lower elevation. Vegetation does not constitute a screen.
- F. Mirrored surfaces or reflective treatments that change or enhance ordinary glass into a mirror surface are prohibited. Permanently reflective metallic surfaces shall be prohibited.

- G. The building design should minimize the reflection of daytime glare from glass and the emission of light from within the structure during evening hours.
- H. The quantity and orientation of skylights shall be designed to minimize night time emission of light and may be allowed upon approval of the Hillside Building Committee.
- I. Shake shingle roofs are prohibited. Existing shake shingle roofs on residential structures may be allowed only until such time that it is determined, during the course of normal maintenance, that a new roof (re-roof) is necessary and/or the extent of maintenance or repair work requires a building permit from the Town.

### **III. LAND DISTURBANCE STANDARDS.**

- A. The limits of construction, demolition, or proposed Disturbed Areas shall be clearly staked in the field, with a minimum barrier of visible roping, prior to and during construction and shall conform to the approved plans. Both during and after construction, no disturbance shall be permitted beyond the areas designated as the limits of disturbance on the plans. If land disturbance in violation of this ordinance occurs, the illegally-Disturbed Area(s) shall be restored to its Natural Grade and re-vegetated with plant material of the same species, size, and at a similar density present prior to the illegal disturbance.
- B. All disturbed land that is not otherwise used for approved development shall be restored to the Natural Grade and re-vegetated with plant material native to the hillside and pursuant to a landscape plan that is appropriate for the site and approved by the Hillside Building Committee or Town Manager or designee.
- C. All buildings, structures, roads, and drives shall, to the fullest extent practicable, follow and utilize the natural contours of the land to minimize disturbance. The maximum height of any Cut used to establish a Building Site shall not exceed 30 feet.
- D. All surplus excavated material shall be removed from the Lot prior to the issuance of the Certificate of Occupancy.
- E. After final Grading, not more than 5% of the Lot shall be steeper than the Natural Grade of the Lot.
- F. The total Disturbed Area shall not exceed the allowed percentage of the Lot area as shown in **TABLE 1** below.
- G. Grading within street rights-of-way or tracts of land for private roads is exempt from the disturbance calculations. Any roadway Grading beyond the limits of the dedicated rights-of-way or private road tracts shall be placed in slope easements and included within the calculations for land disturbance limitations.

- H. A legally pre-existing Disturbed Area may be excluded from Disturbed Area calculations when the applicant complies with all of the following restoration conditions:
1. The restored area shall follow original natural contours.
  2. The restoration shall be treated with an aging agent approved by the Town Manager or Designee and planted with native desert material that is consistent in density with the area surrounding the undisturbed areas abutting the pre-existing Disturbed Area.
  3. The restoration process plan shall be sealed by a landscape architect and/or a registered professional.
- I. On-site storm water retention shall be included in the allowable Disturbed Area. Retention methods (i.e. basins) not employing the use of Retaining Walls, vegetated with native plant material, and designed in accordance with the Town's Storm Drain Design Manual shall count as fifty (50%) percent Disturbed Area.

- J. The livable portion of the main residence including garage and livable portions of detached accessory buildings shall not be counted as Disturbed Area provided that all buildings are within the required setbacks and do not exceed the building height limitations as specified in Section 2207 (II) (A) of this Ordinance.

**TABLE 1 – Slope Category / Lot Disturbance Limitations**

Bldg. Site Slope	% Allowable Land Disturbance	Bldg. Site Slope	% Allowable Land Disturbance	Bldg. Site Slope	% Allowable Land Disturbance
10%	60.0	41%	9.90	72%	6.80
11%	53.66	42%	9.80	73%	6.70
12%	47.94	43%	9.70	74%	6.60
13%	42.81	44%	9.60	75%	6.50
14%	38.21	45%	9.50	76%	6.40
15%	34.11	46%	9.40	77%	6.30
16%	30.48	47%	9.30	78%	6.20
17%	27.27	48%	9.20	79%	6.10
18%	24.46	49%	9.10	80%	6.00
19%	22.01	50%	9.00	81%	5.90
20%	19.88	51%	8.90	82%	5.80
21%	18.04	52%	8.80	83%	5.70
22%	16.48	53%	8.70	84%	5.60
23%	15.16	54%	8.60	85%	5.50
24%	14.05	55%	8.50	86%	5.40
25%	13.13	56%	8.40	87%	5.30
26%	12.37	57%	8.30	88%	5.20
27%	11.76	58%	8.20	89%	5.10
28%	11.28	59%	8.10	90%	5.00
29%	10.90	60%	8.00	91%	4.90
30%	10.62	61%	7.90	92%	4.80
31%	10.41	62%	7.80	93%	4.70
32%	10.25	63%	7.70	94%	4.60
33%	10.15	64%	7.60	95%	4.50
34%	10.08	65%	7.50	96%	4.40
35%	10.04	66%	7.40	97%	4.30
36%	10.02	67%	7.30	98%	4.20
37%	10.01	68%	7.20	99%	4.10
38%	10.00	69%	7.10	100%	4.00
39%	10.00	70%	7.00		
40%	10.00	71%	6.90		



IV. DRIVEWAYS <sup>558</sup>

- A. Driveways that only serve a new single residence shall be: (1) a minimum of 12 feet wide; (2) surfaced with paving brick, textured integral colored concrete (i.e. stamped or exposed aggregate etc.) or other similar decorative paving materials specifically colored to blend with the existing natural color of the site (asphalt Driveways are prohibited); (3) designed with an overall grade that does not exceed 30%; (4) constructed in full conformance with the Fire Code; and (5) developed only as specifically approved by the Hillside Building Committee, Hillside Chair, or Town Manager or designee. The Driveway shall be included in the calculations for land disturbance limitations at a ratio of 50% of the total Disturbed Area of the Driveway, if the Driveway is constructed at a grade plus or minus (6) inches from Natural Grade. Driveways with Cut and Fill in excess of (6) inches and under (18) inches from Natural Grade shall be charged with 75% of the total Disturbed Area of Driveway surface. Driveways with Cut and Fill in excess of (18) inches from Natural Grade shall be charged with 100% of the total Disturbed Area of the Driveway (See Table 2). The entire Driveway must be within the Natural Grade limit to be subject to the disturbance ratios noted above.
- B. Driveways that serve an existing home undergoing renovation, remodel, or an addition shall be included in the calculations for land disturbance limitations subject to the following conditions:
1. Existing Driveways reconstructed or resurfaced with paving bricks, textured integral colored concrete (e.g. stamped or exposed aggregate etc.) or other similar decorative paving materials, specifically colored to blend with the existing natural color of the site, shall be excluded from the land disturbance calculations.
  2. Existing asphalt or uncolored concrete Driveways not reconstructed with paving bricks or textured integral colored concrete (e.g. stamped or exposed aggregate etc.) shall be calculated as Disturbed Area at a ratio of 150% of the total Disturbed Area of the Driveway.
  3. Any new portions of the Driveway beyond the layout of the existing Driveway shall be included in the calculations for land disturbance limitations at a ratio of 50% of the total Disturbed Area of the Driveway, if the Driveway is constructed at a grade plus or minus (6) inches from Natural Grade. Driveways with Cut and Fill in excess of (6) inches and under (18) inches from Natural Grade shall be charged with 75% of the total Disturbed Area of Driveway. The Driveways with Cut and Fill in excess of (18) inches from Natural Grade shall be charged with 100% of the total Disturbed Area of the Driveway (See Table 2). The entire Driveway must be within the Natural Grade limit to be subject to the disturbance ratios noted above.

- C. The minimum standard turning radius for a Driveway is 40 feet; except that a minimum 35-foot radius may be used provided all structures are protected with an approved fire extinguishing system or as deemed necessary by the Town Fire Marshal.
- D. Any street or Driveway Cut greater than 8 feet shall not have a length greater than 100 feet. The applicant must mitigate means of breaking-up the mass of the Cut and blending the Cut in with the surrounding natural terrain.
- E. A twenty (20) foot by thirty (30) foot Driveway apron may be required by the Fire Marshall or the Building Official at or near the garage or another location deemed necessary by the Fire Marshal, with no more than a 5% grade, to serve as a staging platform to fight a fire.
- F. The maximum height, measured vertically, of any Cut used to establish a street or Driveway shall not exceed 30 feet.

**Table 2 – Summary of Decorative Driveway Disturbance**

Decorative Driveways for Remodeled Homes	Decorative Driveways for New Homes
<p>100% Disturbance Credit for Existing Driveway Area</p> <p>New Driveway Beyond the Existing Layout/Driveway Area Receives Partial Credit:</p> <ul style="list-style-type: none"> <li>▪ 50% credit within 6” of Natural Grade</li> <li>▪ 25% credit over 6” and under 18” of Natural Grade</li> <li>▪ 0% credit if 18” or greater from Natural Grade</li> </ul>	<p>50% credit within 6” of Natural Grade</p> <p>25% credit over 6” and under 18” of Natural Grade</p> <p>0% credit if 18” or greater from Natural Grade</p>

**V. GRADING AND DRAINAGE STANDARDS.**

- A. There shall be no clearing, grubbing, Grading, importing or stockpiling of Fill material on, or to, any site prior to approval of such Development by the Hillside Building Committee and approval of a Grading plan by the Town, unless such clearing, grubbing, or Grading, is required by the Town for public safety purposes. If applicable, approval of a Grading plan and drainage report prepared by a registered Engineer may be required for Town review and approval.
- B. The maximum depth of Fill shall not exceed 7.5 feet except beneath the Footprint of the main residence. All exposed Disturbed Area Fill shall be contained behind

Retaining Walls or covered with a natural rock veneer and treated with an aging agent and landscaped with indigenous plant material.

- C. Veneered Rock Slopes may be allowed provided that they are approved by the Hillside Building Committee, and:
  - 1. The vertical height of the Veneered Rock Slope does not exceed the vertical height of the exposed Cut with the base of the Veneered Rock Slope structurally engineered for stability.
  - 2. The Veneered Rock Slope does not exceed a one to one slope.
  - 3. Retaining Walls used to limit the height of the Veneered Rock Slope are color treated or veneered to blend in with the surrounding natural colors.
- E. Raw Spill Slopes are prohibited. Any violation will be subject to a stop work order until the spill slope is removed, restored to its Natural Grade, re-vegetated and approved by the Town.
- F. Storm water requirements for Off-Site and On-Site Storm water shall be per the Town of Paradise Valley Storm Drainage Design Manual.
- G. A Hillside Wash shall not be diverted, relocated or moved from its present position to another location, however, a Hillside Wash may be bridged by a structure so long as such structure does not impede the flow of the Hillside Wash.
- H. Washes located on a property shall be maintained in accordance with Chapter 5 and Chapter 8 of the Town Code and the Town's Storm Drainage Design Manual.

**VI. WALLS AND FENCES.** <sup>558</sup>

- A. Curbs 8 inches or less in height above Finished Grade are not considered walls.
- B. No more than 300 total linear feet of wall shall be visible from any point on the property line. All pool barriers shall be View Fencing. View Fencing is not calculated in the 300 foot maximum allowable wall length.
- C. Walls that are otherwise permissible in Article XXIV are prohibited in the Hillside Development Area. Retaining Walls, pool barriers, walls used to screen mechanical equipment, Driveway columns and entry gates, and tennis/sport court fencing are allowed provided that they are of minimum lengths and heights, as further specified below, and are approved by the Hillside Building Committee.
  - 1. Retaining Walls:

- a. The intent of the Retaining Wall requirements is to mitigate the massing and impact of walls on the hillside and preserve the characteristics of the desert. The objective is to allow only the minimum amount of Retaining Walls needed to access the property, retain Cut and Fill, and screen mechanical equipment and windows of interior bathroom areas.
- b. Where Retaining Walls are provided, they shall meet the setback requirements of Article XXIV, Height and Setback Regulations, unless needed to access the property (such as Driveway Retaining Walls) or deemed necessary by the Town Engineer and the Community Development Director to prevent erosion or flooding.
- c. The maximum length of any continuous Retaining Wall shall not be more than 100 linear feet. The maximum height of any Retaining Wall shall not be more than 8 feet. The height of a Retaining Wall is measured from the low side of Natural Grade when retaining Fill slopes and from Finished Grade when retaining Cut slopes to the top of the wall; whether the top is retaining earth or not.
- d. Retaining Walls shall be used for the purpose of containing Fill material or for minimizing Cut or Fill slopes. The Retaining Wall may only extend six (6) inches above the material it is retaining.
- e. A terraced combination of Retaining Walls shall be measured as a single Retaining Wall provided the combined walls are: 1) no more than eight (8) feet total vertical height; 2) terraced with a minimum distance between of four (4) feet and a maximum separation of eight (8) feet; and 3) contain appropriate vegetation between the walls so as to soften the visual impact of the combined walls (see **FIGURE 8**). These separation requirements apply to any single Lot and do not apply to adjoining walls on neighboring properties.
- f. When a safety fence, on top of a Retaining Wall, is required by code it shall be a View Fence, with a minimum height per building code and a maximum height up to 42" (as determined by the Hillside Building Committee), and shall be painted to blend with surrounding natural colors.
- g. Where Retaining Walls are provided they shall be color treated, textured, or veneered to blend in with the surrounding natural colors and textures of the native rock and soils at the site.

**FIGURE 8 –TERRACED VERTICAL RETAINING WALLS**

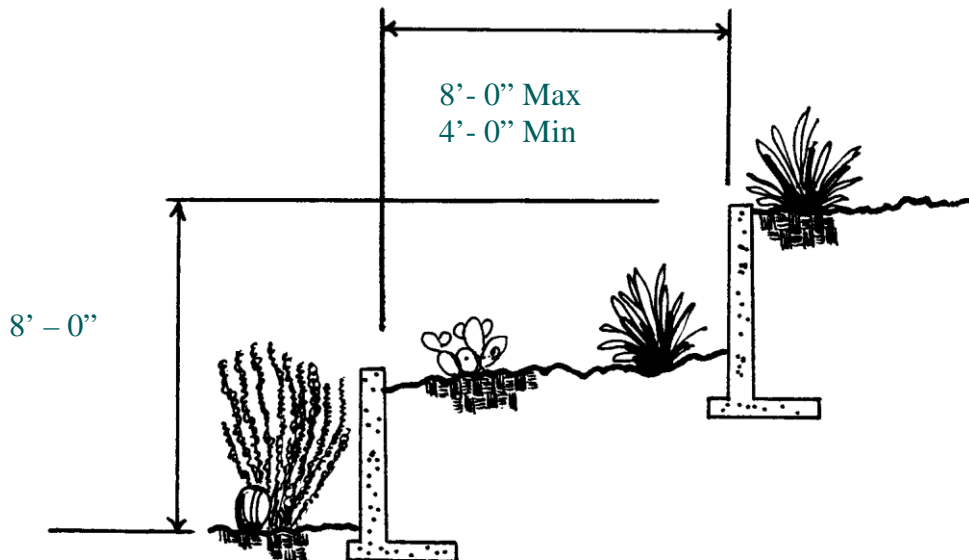

2. Pool Barriers. All pool barriers shall be View Fencing. The pool barrier shall be the minimum amount that is needed to secure the pool and that is appropriate for the site.
3. Screen Walls: These walls may be solid walls provided they are of minimum height and length needed to screen the mechanical equipment, garbage cans, or windows of interior bathroom areas, and shall not exceed six (6) feet in height. Screen walls over 6 feet in height may be allowed, at the discretion of the Hillside Building Committee, to properly screen the mechanical equipment or windows of interior bathroom areas; provided, 1) such walls meet the allowable setbacks and height of an accessory structure, and 2) screening area surrounded by screen walls is calculated as part of the allowable floor area.
4. Tennis/Sport Courts: Fences surrounding a Tennis Court or Sport Court shall be View Fencing no greater than 10 feet high as measured from the playing surface and shall be colored to blend in with the surrounding area. The enclosed area of the Fencing and the Tennis/Sport Court shall be counted as Disturbed Area.
5. Driveway columns and entry gates may be located ten (10) feet or more from the property line. The columns and gate are limited to six (6) feet in height and the columns may be a maximum size of two (2) feet by two (2) feet. Electrically controlled gates must be equipped with an approved key switch located as far as possible from the right-of-way.
6. Driveway Retaining Walls. Driveway Retaining Walls may extend 18 inches above the driving surface provided the Retaining Wall does not exceed the 8-foot height limit. When a safety fence on top of a Driveway Retaining Wall is required by code, it shall be a View Fence with a minimum height per building code and a maximum height of 42" (as

deemed appropriate by the Hillside Building Committee) and shall be painted to blend with surrounding natural colors. The Retaining Wall must comply with the 8-foot height limit; however, the view guard is not limited to the 8 foot Retaining Wall height limit.

DRAFT



**VII. ACCESSORY STRUCTURES AND ADDITIONS TO EXISTING STRUCTURES.** <sup>558</sup>

- A. Any proposed accessory structure or improvements to existing hillside structures which require additional Disturbed Area shall be accompanied by calculations of prior Disturbed Area to determine if the entire site is within the allowed limits for hillside construction. When the Disturbed Area equals that allowed, no further construction involving additional Disturbed Area will be permitted.
- B. Accessory buildings and structures shall not occupy more than one-half of the total ground area of the main building. No accessory building or structure shall exceed the height specified in Table 1001B of Article 10 of the Town Zoning Ordinance or elsewhere in this ordinance.

**VIII. SEWERS AND UTILITIES.**

- A. Grading for septic systems, evapotranspiration systems, and alternative systems shall be included in the calculations for land disturbance limitations unless:
  - 1. The Disturbed Area is brought back to original Natural Grade contours, treated with an approved aging agent and planted to blend with surrounding natural growth,
  - 2. Special landscape plans for evapotranspiration systems shall be submitted to the Town Engineer. Plans shall show the appropriate vegetation and supplemental irrigation systems approved by the Town Engineer.
- B. Grading for utility lines, including water and sewer lines and lateral lines, electric, gas, telephone and cable services, shall be included within the calculations for land disturbance limitations unless:
  - 1. Trenches are placed under a Driveway, under paving or in other areas already counted as disturbed,
  - 2. Trenches and related Disturbed Areas are restored to appear as original ground, color treated and planted to blend with surrounding natural growth.

**IX. FIRE PROTECTION.**

- A. Washes must be maintained as easements as described in Section 8-7 of the Town Code and other applicable codes to minimize the risk and spread of fire.

- B. Grasses known to be highly flammable, such as fountain grass, *Pennisetum setaceum*, and buffel grass, *Pennisetum ciliare* are not allowed in a Hillside Development Area.

**Section 2208**      **OUTDOOR LIGHTING** <sup>558</sup>

- A. Purpose: The intent of these lighting requirements is to preserve the low light level conditions that are inherently characteristic of the desert. The objective is to allow only the quantity and level of lighting necessary for safety, security and the enjoyment of outdoor living while protecting against direct glare and excessive lighting; protecting the ability to view the night sky; and preventing light trespass.
- B. Definitions: For the purposes of this section, exterior lighting is defined and regulated by the following definitions and categories:
1. Footcandle (fc) - A unit of illuminance of equal to 1 lm/ft<sup>2</sup> (lumen / sq. ft.) or 10.76 lx (lux).
  2. Fully Shielded (Full Cut-Off) - A fixture shielded with an opaque material so that light rays emitted by the fixture are projected only below a horizontal plane running through the lowest point on the fixture where light is emitted.
  3. Lumens – The Standard International (SI) unit of luminous flux.
  4. Luminaires (Light Fixtures) - A complete lighting unit consisting of a lamp or lamps and ballast(s) (when applicable) together with the parts designed to distribute the light, position and protect the lamps, to connect the lamps to the power supply.
  5. Lux - A unit of measure of the intensity from light of a candle illuminating a one meter square surface, one meter from the candle. One foot-candle equals approximately 10 Lux.
  6. Opaque - Impervious to the passage of light.
  7. Partially Shielded (Partial Cut-Off) - A fixture that allows light rays to be emitted up and down and shielded with an opaque material in such a manner to prevent the bulb from being seen.
  8. Safety Lighting - Low-level lighting used to illuminate vehicular and pedestrian circulation.
  9. Security Lighting - Lighting that is fully shielded that is intended to provide bright illumination during emergency situations only.

10. Spill Light - The amount of light that illuminates beyond the range or primary area that the fixture is intended to light.
11. Translucent – A material through which light can pass but the light source cannot be seen.
12. Trespass Lighting - Spill light that encroaches onto neighboring properties.
13. Visual Enjoyment Lighting - Lighting intended to illuminate outdoor living areas.

C. Design Standards:

1. All building mounted light fixtures shall be fully shielded. Recessed lights in exterior soffits, eaves, or ceilings shall have a 45° cutoff. At the main entry of the primary structure, a maximum of two (2) translucent fixtures may be permitted as long as the total lumens, per fixture, do not exceed a maximum of 750 lumens. All other entrances, excluding garage doors, shall be limited to no more than one (1) fixture.
2. All fixtures, unless otherwise allowed, shall be directed downward and properly aimed on the targeted areas to maximize their effectiveness and minimize the total number of lighting fixtures.
3. Building mounted lighting must be directed downward away from adjacent Lots, streets, undisturbed Areas, and open spaces, and may not be used to light walls or building elements for decorative purposes.
4. There shall be no lighting permitted in areas identified as “undisturbed areas” of the property pursuant to the plans submitted under Section 2207 III.A.
5. The maximum lighting intensity shall not exceed 0.25 footcandle when measured at the property line.
6. A repetitive line up of lights along Driveways or walkways accessing public streets shall not be allowed. Some random lighting of Driveways or walkways accessing public streets may be allowed by the Hillside Building Committee. Driveway lights must be located on the "downhill" side and aimed toward the "uphill" side, must be fully shielded from below and only light the driveway surface. Driveway and walkway lights shall not exceed a maximum of 0.25fc at any point beyond 10 feet from the fixture.
7. Each lighting or illuminating device shall be set back from the nearest property line a minimum of ten (10) feet or a distance equal to or greater than the height of the device above natural or excavated grade, whichever is greater. As an exception a lighted entry marker may be placed on each

side of the Driveway entrance. The entry marker shall not be placed within the Town right-of-way or private road areas and the total height of the marker and light shall not exceed four (4) feet above Finished Grade adjacent to the Driveway. The light source shall not exceed the equivalent projected brightness of 250 lumens.

D. Luminaires (Light Fixtures) All luminaires shall be subject to the following limitations:

1. Shall not exceed 750 lumens when attached to a structure and confined to the immediate vicinity of a building entrance or outdoor living area of the residence.
2. Shall not exceed 250 lumens for all other uses.
3. Shall not exceed 150 lumens for landscape up-lighting.
4. Motion sensor/detector light fixtures are permitted for security lighting. Security lighting must be controlled separately from all other lighting. Security lights must be on timers that regulate their operation time to a maximum of 10 minutes and limited to lamps with a maximum of 750 lumens.
5. Rope lighting shall not exceed 3.6 watts per lineal foot for an incandescent rope light.
6. Exterior light fixtures shall not exceed 3000 Kelvins.

E. Mounting Exterior fixtures shall be mounted:

1. In the ground or on a post not to exceed 36 inches above the ground. When exterior fixtures are affixed to existing trees, the height of the fixture shall not exceed 8 feet above the Finished Grade.
2. In or on a building wall not to exceed 8 feet above Finished Grade and shielded in such a manner as to avoid creating concentrated light (hot spots) on the structures to which they are mounted. Security lighting may be mounted on the structure to a height of not more than twelve (12) feet.

F. Landscape Up-lighting:

1. The number of fixtures is limited to one fixture per 1000 square feet of allowable Disturbed Area.
2. The lamp must be recessed to provide a minimum 45° cut-off from the vertical plane.

**FIGURE 9 - TYPICAL UPLIGHT WITH 45° CUT-OFF**

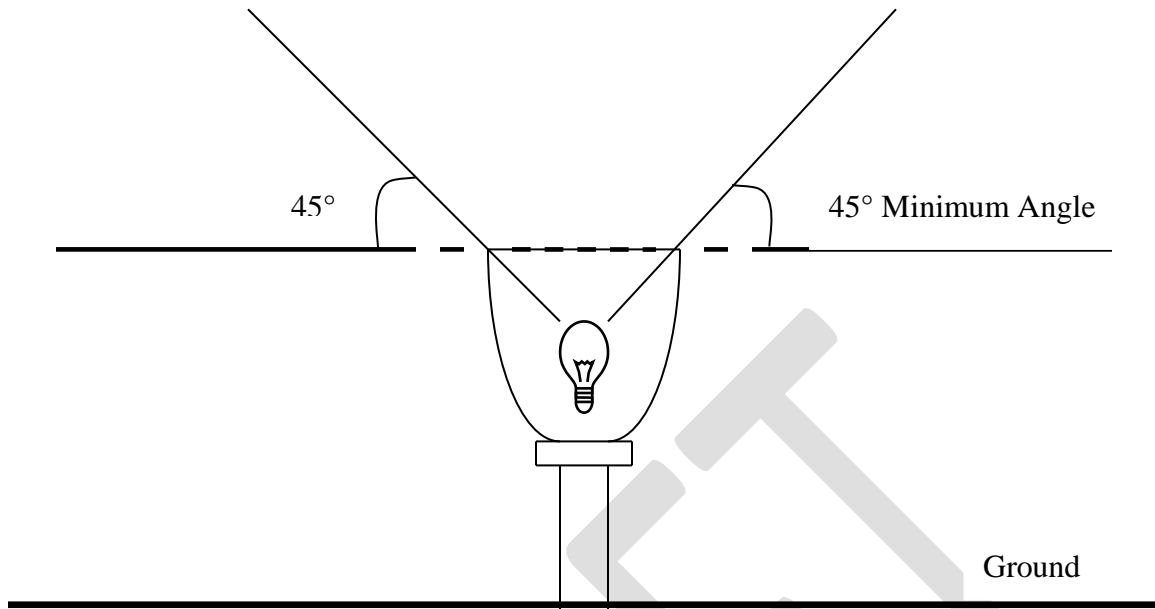

- G. Prohibitions In addition to the limitations noted above, the following lights or lighting effects are strictly prohibited:
1. Colored lamps or bulbs and string and unshielded rope lights; except that temporary holiday lighting shall be permitted between October 15<sup>th</sup> and January 15<sup>th</sup>.
  2. Tennis court and sport court lighting.
  3. Any temporary lighting that violates the provisions of this lighting section.
  4. Exterior lights, except security lighting, that illuminate the adjoining mountainside such that the mountainside is visible from off the property between sunset and sunrise.
- H. Amendments:
1. Should the applicant desire to substitute outdoor light fixtures or lamps after a permit has been issued, the applicant must submit all changes to the Town Engineer for approval, with adequate information to assure compliance with this ordinance.

**Section 2209. DENSITY and SUBDIVISIONS / LOT SPLIT STANDARDS**

- A. The maximum number of Lots into which Hillside Development Area land may be subdivided shall be the sum of the number of Lots allowed in each slope category of land as shown by the following **TABLE 3 – Density/Slope Category**.
- B. Slope shall be calculated using a minimum of 3 slope lines per Acre. The slope lines shall be perpendicular to the slope and at equal spacing across the Lot. The average slope is calculated by multiplying the length of each slope line by its slope, add all these values together, and then divide this amount by the total length of all the slope lines (see Figure 10).
- C. Each of the resulting Lots shall meet the minimum Lot size requirements based upon the average Lot slope shown on **TABLE3**.
- D. Building envelopes shall be conceptually indicated on preliminary plats and accurately shown on final plats.
- E. The subdivider shall provide plans and documents by a registered architect, civil engineer, or surveyor demonstrating that roads, public or private, and Driveway access and placement of residential structure will conform, for each Lot, to current hillside development regulations and without the need for a variance.

- F. All subdivision development and Lot split applications shall comply with the Hillside Development Requirements as outlined in the Town of Paradise Valley Subdivision Ordinance and Article XXII of this Ordinance.

**FIGURE 10 – SLOPE LINES PER ACRE**

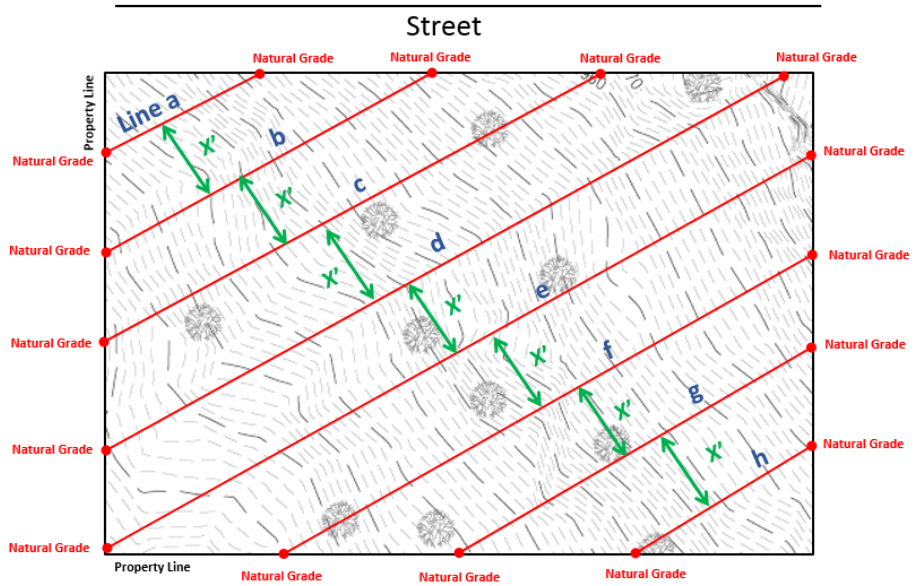

(2.5 acres) x (3 Slope Lines per Acre) = 7.5 Lines which Rounds Off to 8 Slope Lines

$((\text{Line a Length} \times \text{Slope}) + (\text{Line b length} \times \text{Slope}) + (\text{Line c Length} \times \text{Slope}) + (\text{Line d Length} \times \text{Slope}) + (\text{Line e Length} \times \text{Slope}) + (\text{Line f Length} \times \text{Slope}) + (\text{Line g Length} \times \text{Slope}) + (\text{Line h Length} \times \text{Slope})) / (\text{Summation of All the Slope Line Lengths}) = \text{Average Lot Slope}$

Use the Average Lot Slope % in Table 3 to Determine Minimum Allowable Lot Size

**TABLE 3 – Density / Slope Category**

Average Lot Slope %	Min. Lot Size Acres	Min. Lot Size –Sq. Ft.	Average Lot Slope %	Min. Lot Size Acres	Min. Lot Size – Sq. Ft.
10%	1	43,560	41%	6.8	296,208
11%	1.01	43,996	42%	7.6	331,056
12%	1.02	44,431	43%	8.4	365,904
13%	1.04	45,302	44%	9.2	400,752
14%	1.06	46,174	45%	10	435,600
15%	1.08	47,045	46%	11	479,160
16%	1.1	47,916	47%	12	522,720
17%	1.2	52,272	48%	13	566,280
18%	1.3	56,628	49%	14	609,840
19%	1.4	60,984	50%	15	653,400
20%	1.55	67,518	51%	16	696,960
21%	1.6	69,696	52%	17	740,520
22%	1.7	74,052	53%	18	784,080
23%	1.8	78,408	54%	19	827,640
24%	1.9	82,764	55%	20	871,200
25%	2	87,120	56%	21	914,760
26%	2.2	95,832	57%	22	958,320
27%	2.4	104,544	58%	23	1,001,880
28%	2.6	113,256	59%	24	1,045,440
29%	2.8	121,968	60%	25	1,089,000
30%	3	130,680	61%	26	1,132,560
31%	3.2	139,392	62%	27	1,176,120
32%	3.4	148,104	63%	28	1,219,680
33%	3.6	156,816	64%	29	1,263,240
34%	3.8	165,528	65%	30	1,306,800
35%	4	174,240	66%	32	1,393,920
36%	4.4	191,664	67%	34	1,481,040
37%	4.8	209,088	68%	36	1,568,160
38%	5.2	226,512	69%	38	1,655,280
39%	5.6	243,936	70%	40	1,742,400
40%	6	261,360			

**Section 2210. REMOVAL OF PROPERTY FROM HILLSIDE**

The Hillside Building Committee and Town Council shall review plans for any request to remove a property from the Hillside Development Area. This process applies to properties that are designated within a Hillside Development Area and have a slope of less than ten percent (10%). If a property owner elects to remove the property from the Hillside Development Area, the following applies:



1. The applicant must provide documentation that the property has a Building Pad Slope and site slope of less than ten percent (10%) in accordance with Section 2202 and Section 2209B.
2. The request will be reviewed by the Hillside Building Committee, which will make a recommendation of approval, approval with stipulations, or denial to remove the property from the Hillside Development Area.
3. The applicant shall have no other code violations;
4. The Town Council will either approve, deny, or approve the request with stipulations, which may include eliminating any non-conformities.

**FOOTNOTE:**

110 Ordinance # 220 – 7/12/84  
112 Ordinance #221 – 9/24/84  
181 Ordinance # 305 – 11/9/89  
193 Ordinance # 320 – 2/28/91  
194 Ordinance # 321 – 2/28/91  
206 Ordinance # 338 – 3/26/92  
382 Ordinance # 382 – 12/01/94  
409 Ordinance #409 - 7/13/95  
425 Ordinance # 425 – 9/12/96  
533 Ordinance # 533 – 10/09/03  
558 Ordinance # 558 – 06/09/05  
580 Ordinance # 580 – 10/26/2006  
654 Ordinance #654 – 03/13/2014

Section 2 If any section, subsection, sentence, clause, phrase or portion of this ordinance or any part of these amendments to the Town Code adopted herein by reference is for any reason held to be invalid or unconstitutional by the decision of any court of competent jurisdiction, such decision shall not affect the validity of the remaining portions thereof.

Section 3. This ordinance shall become effective in the manner provided by law.

PASSED AND ADOPTED by the Mayor and Council of the Town of Paradise Valley, Arizona, this \_\_\_\_ day of \_\_\_\_\_, 2018.

\_\_\_\_\_  
Michael Collins, Mayor

SIGNED AND ATTESTED TO THIS \_\_\_\_\_ DAY OF \_\_\_\_\_ 2017

ATTEST:

\_\_\_\_\_  
Duncan Miller, Town Clerk

APPROVED AS TO FORM:

---

Andrew M. Miller, Town Attorney

DRAFT