

TOWN OF PARADISE VALLEY

Paradise Valley Medical Plaza

Intermediate Special Use Permit Amendment

Town Council

Work Session

January 24, 2019



TODAY'S GOAL

- Review PV Medical Plaza Intermediate SUP Amendment for New Medical Building, New Covered Parking Canopies & New Signage
- Provide Staff with Input and Direction Regarding Request and Ordinance 2019-01



AGENDA

- Background/Summary of Request
- Statement of Direction
- Scope of Request
- Recommendation & Action



VICINITY MAP

Subject Property

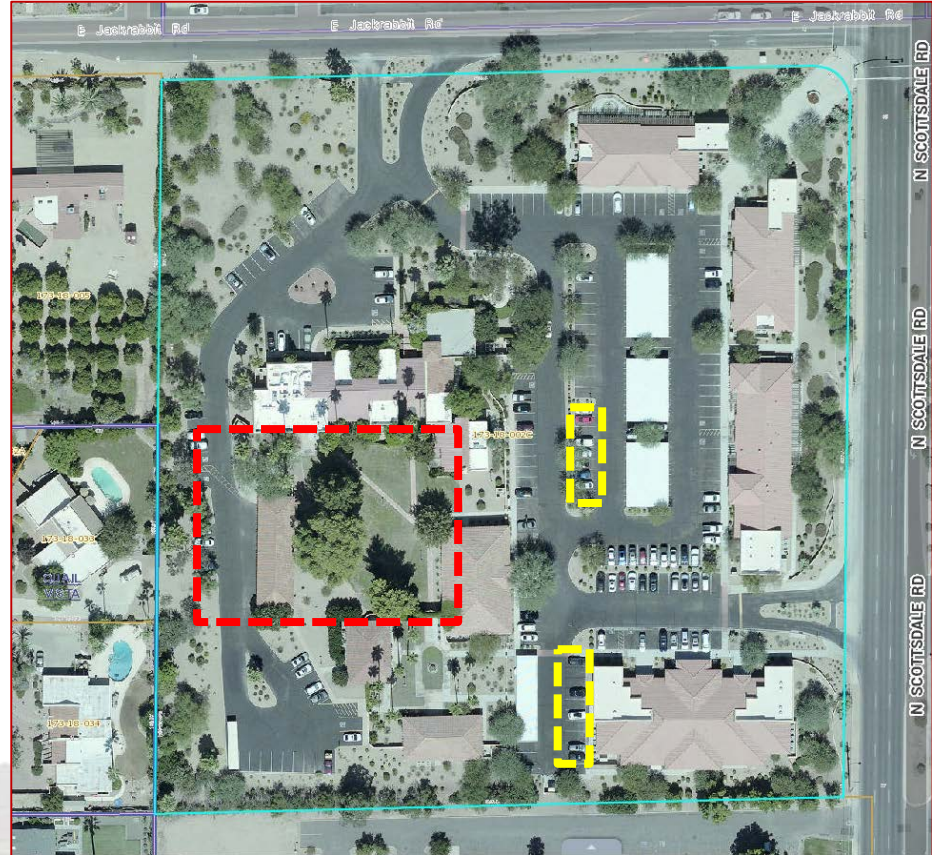
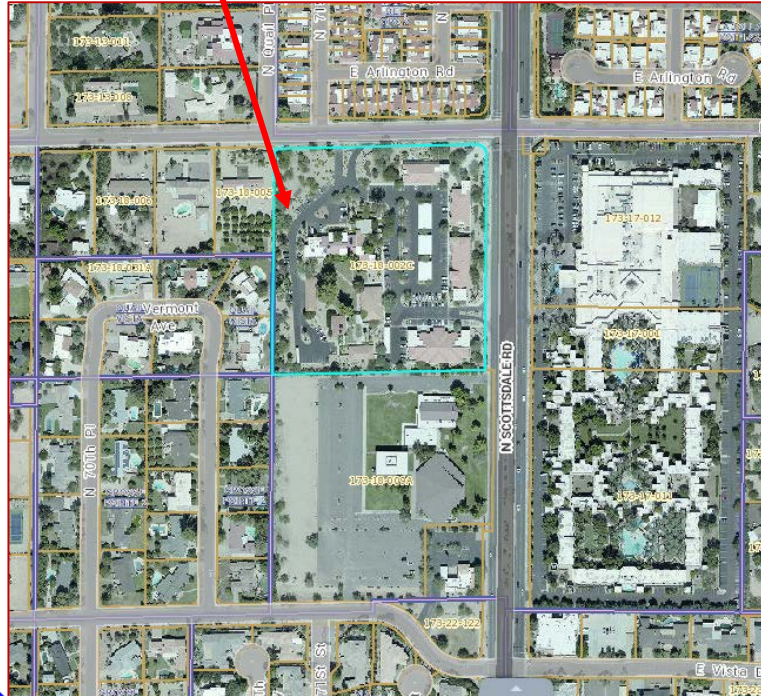

HISTORY

- Special Use Permit (SUP):
 - Issued 1979
 - 2003 Amendment to add 5 Bldgs, New Parking, Signage, Landscaping & Lighting
- Statement of Direction (SOD):
 - TC Issued SOD on November 15, 2018



BACKGROUND

- December 4th PC WS & December 18th PC PH:
 - Modified Ord. 2019-01 by removing reference to prior plans that no longer in effect and approval for monument sign which included property address and name of medical plaza on top of sign
 - Forward Ordinance 2019-01 to TC with Recommendation of Approval by vote of 6 to 0



SUMMARY OF REQUEST

- Intermediate SUP Amendment:
 - Medical Building
 - New Parking Area
 - 2 Covered Parking Canopies
 - Landscape/Hardscape Improvements
 - New Signage

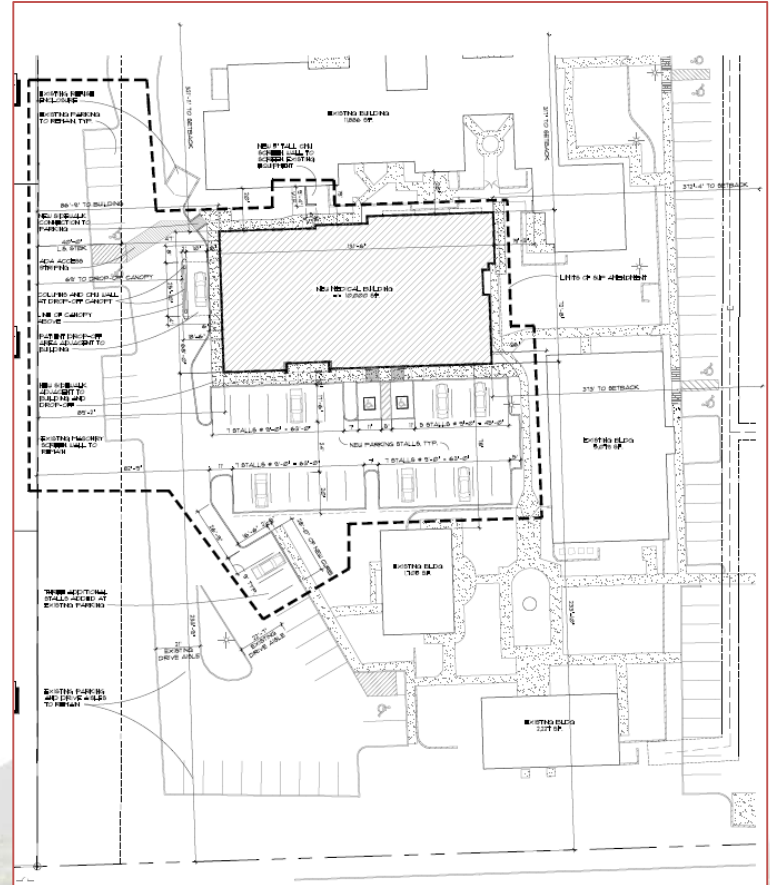

January 24, 2019



STATEMENT OF DIRECTION (SOD)

- PC shall focus review on visible, audible, and operational effects amendment may have on neighbors. In particular, PC shall focus their review on:
 1. **Use.** Current use is medical office and this use will not change. However, one additional surgical facility will be added to the center. The PC shall evaluate if additional changes or measures are needed to mitigate any adverse effects created by the patient drop-off area and/or the increased intensity of use.
 2. **Traffic, Parking, and Circulation.** Existing ingress/egress points and drive aisles will remain and 33 new parking spaces will be added to accommodate new medical building. Attention shall be given to parking lot location, number of parking spaces, and dimension of parking spaces. The PC shall evaluate the parking analysis to determine if total number of provided parking spaces will accommodate improvements.



SOD (CONT.)

3. **Signage.** PC shall evaluate any proposed signage associated with these improvements. Attention shall be paid to building mounted signage, directional signage, and resulting impact to neighbors including the location, dimensions, and illumination of any new signs.

4. **Impact to Adjacent Properties.** PC shall consider how proposed setbacks, heights, location of uses, and any other related design aspect (including, but not limited to noise and lighting) of improvements that may negatively impact nearby properties.
 - PC may request clarification and/or expansion of SOD based on additional information that has evolved

 - PC shall complete their review by **February 14, 2019**

MEDICAL BUILDING

- 10,000 sq ft
- Single Story - 20'1" Tall
- 69' setback from west/closest p.l.
- Uses:
 - Medical Office
 - Surgical Facility
- Screen wall at patient drop-off area
- Wall mounted sconces (0-ft candles at property line)
- Architecture to match existing on campus

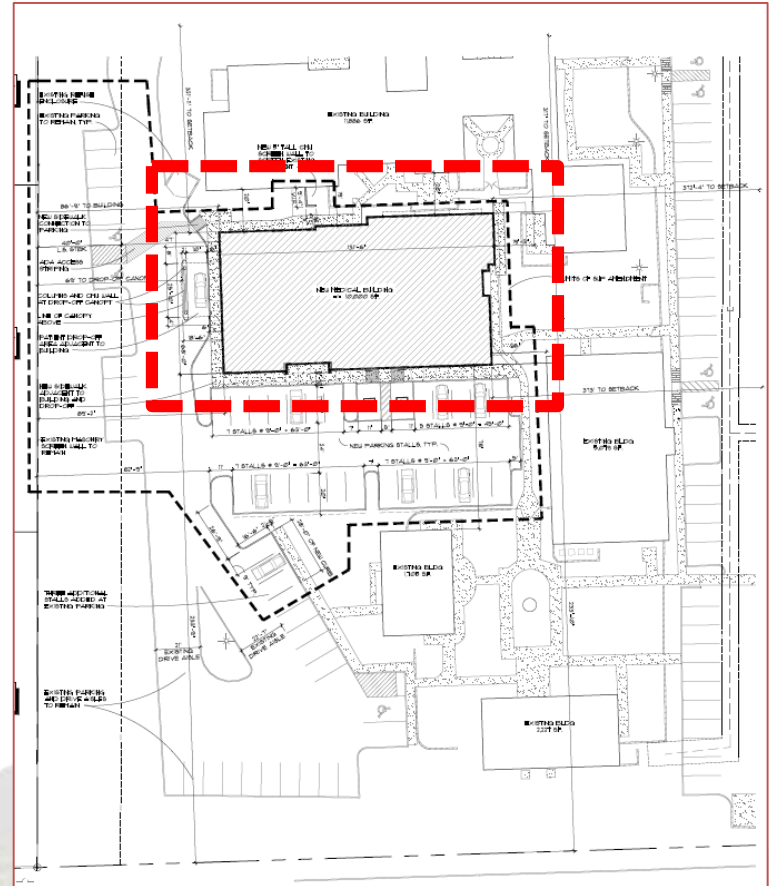

MEDICAL BUILDING

Site Plan

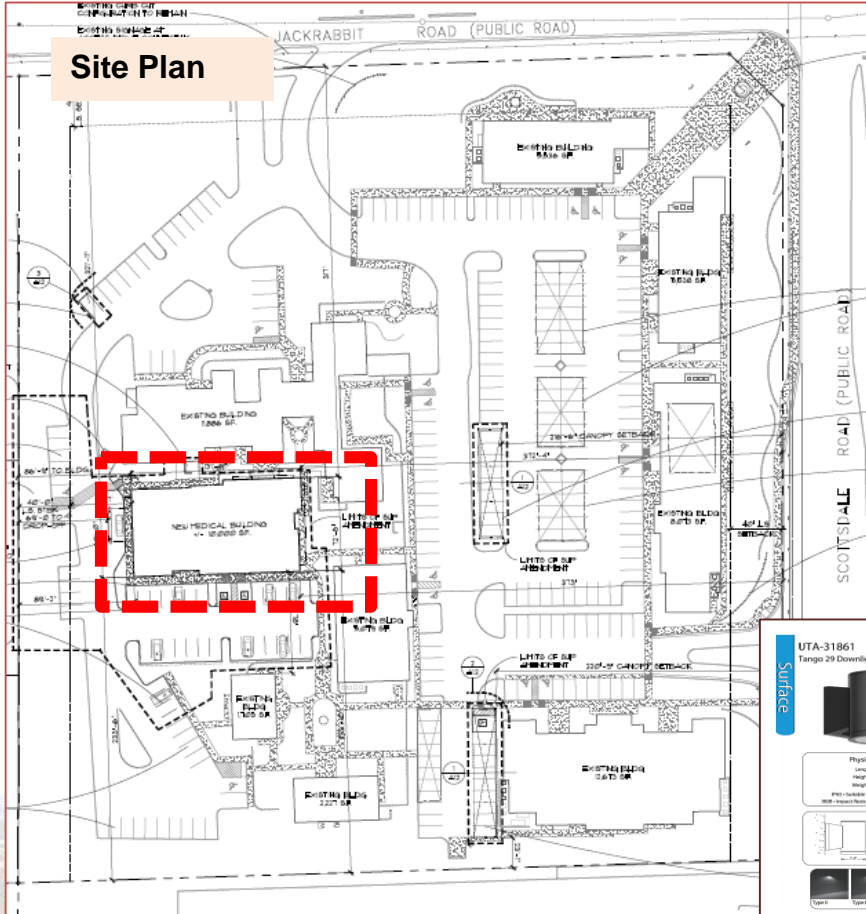

Building Elevation

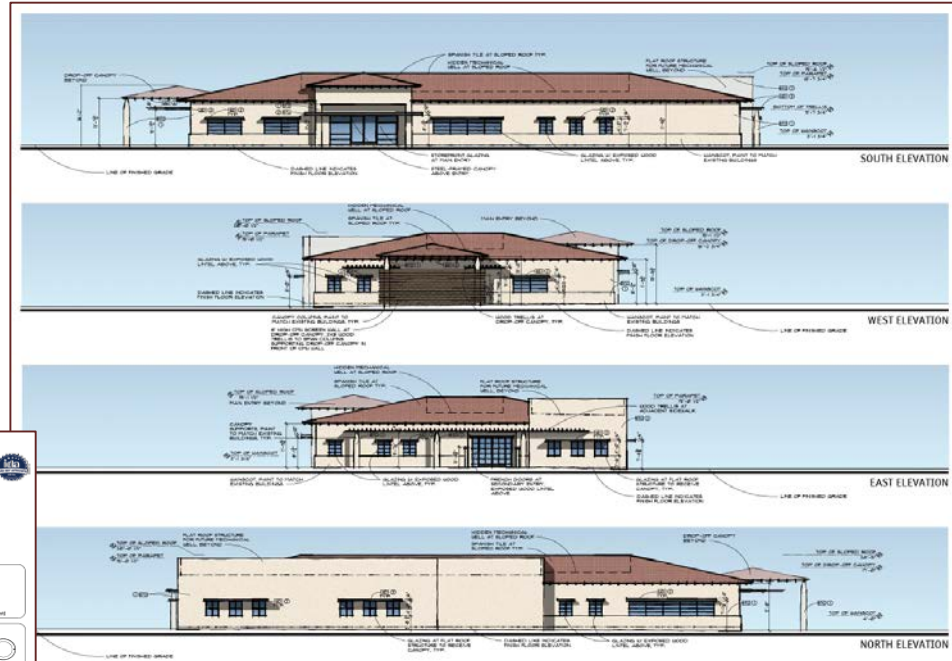

UTA-31861
Tango 29 Downlight

Physical Data
Length: 17"
Height: 107"
Depth: 4 1/2"

PHI - Qualified for Wet Locations
IP65 - Impact Resistant - Shatter Resistant

Type I Type II Type III

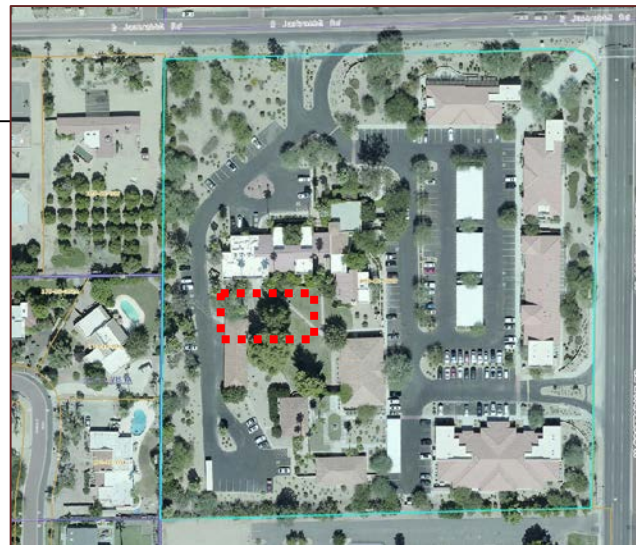

PHOTOS

January 24, 2019

NEW SCREEN WALL

- 5' tall screen wall around existing surgery building equipment
- Stucco and paint finish to match

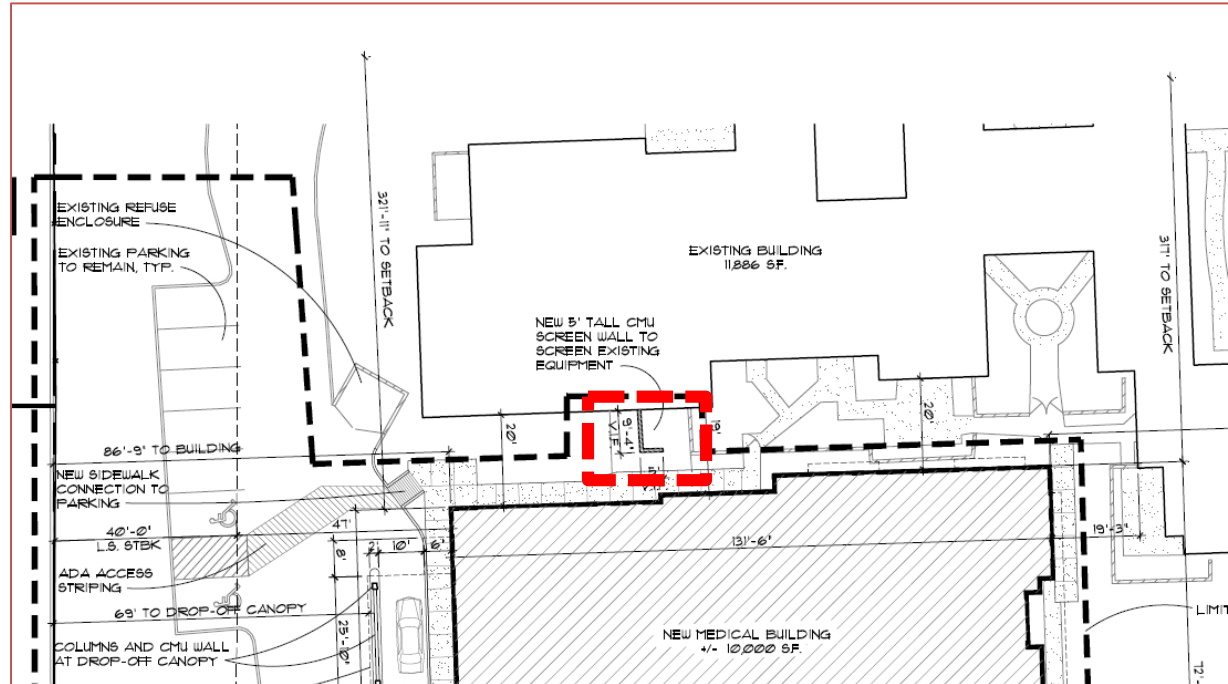

NEW PARKING

- 33 Spaces (243 exist to 276 proposed)
- Parking Analysis Provided:
 - 276 spaced needed
- 4 Pole Lights:
 - 8' tall
 - Match Existing Lights
 - 0-ft candles at p.l.

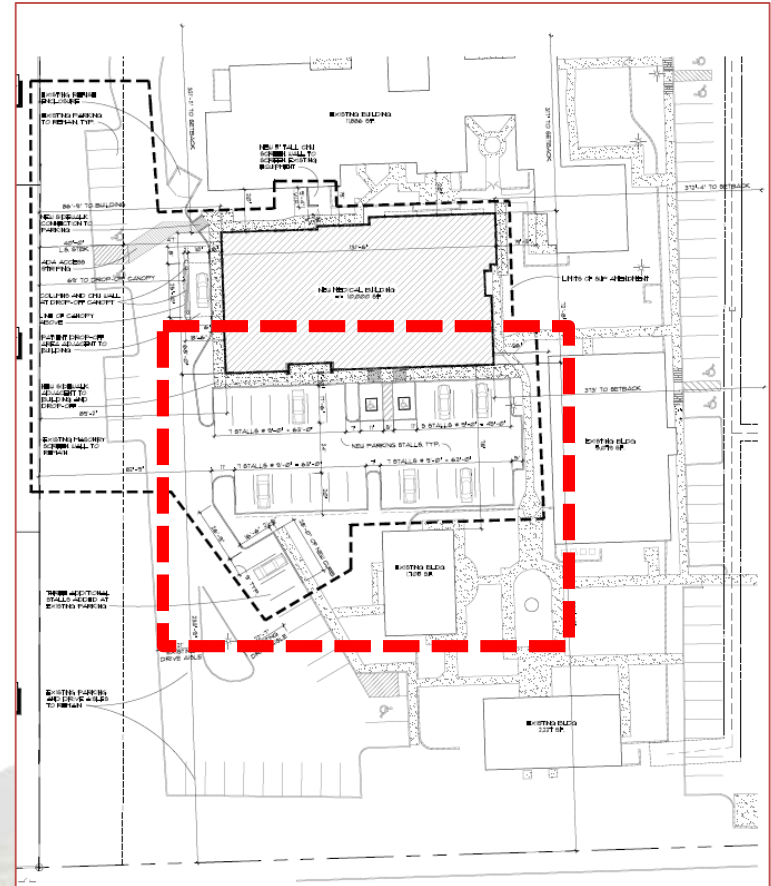
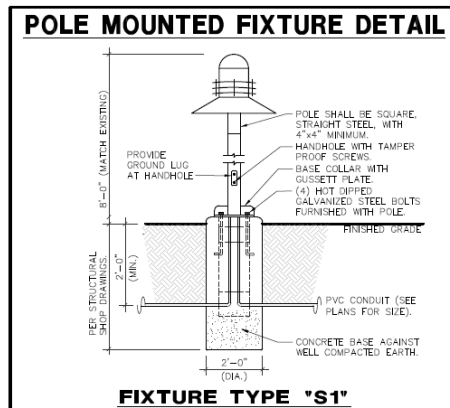

January 24, 2019



PHOTOS



PHOTOS



NEW LANDSCAPING

- Placed around new building and parking area
- No new landscape lighting
- Palette:
 - Palo Verde Trees
 - Red Yucca
 - Desert Spoon
- 9 More Palo Verdes Added

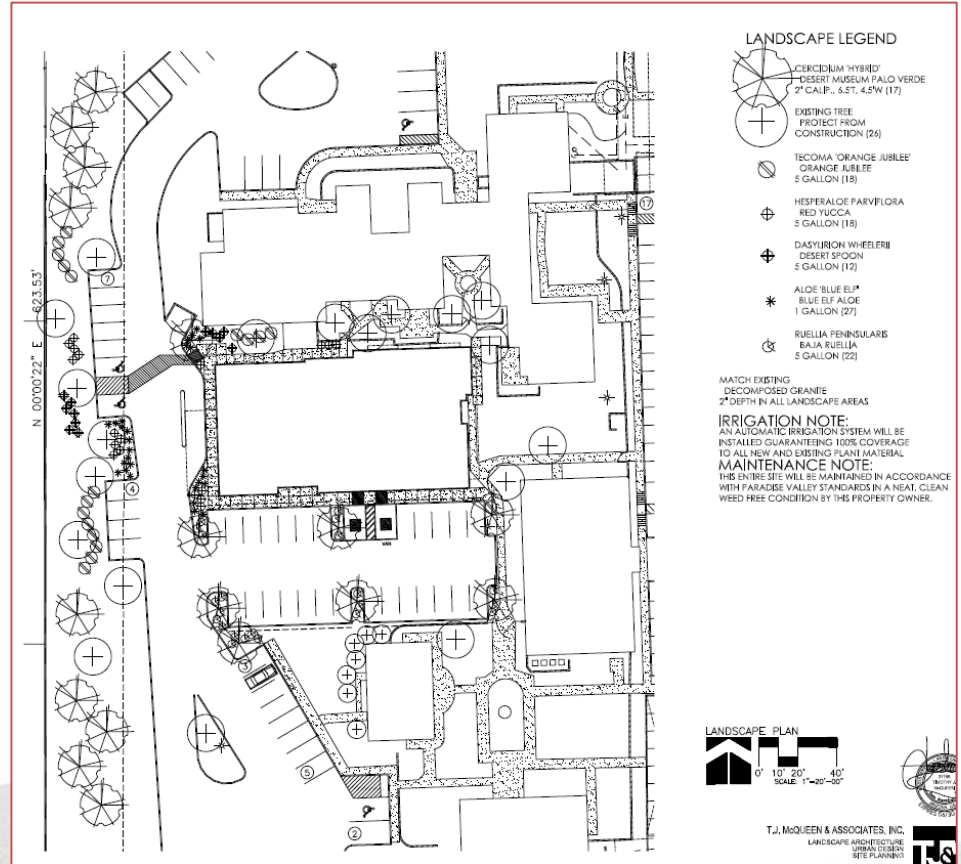

SIGNAGE

- 4 New Types of Signage:
 - Monument Sign
 - Tenant/Directional Sign
 - Tenant ID Signs
 - Building Sign

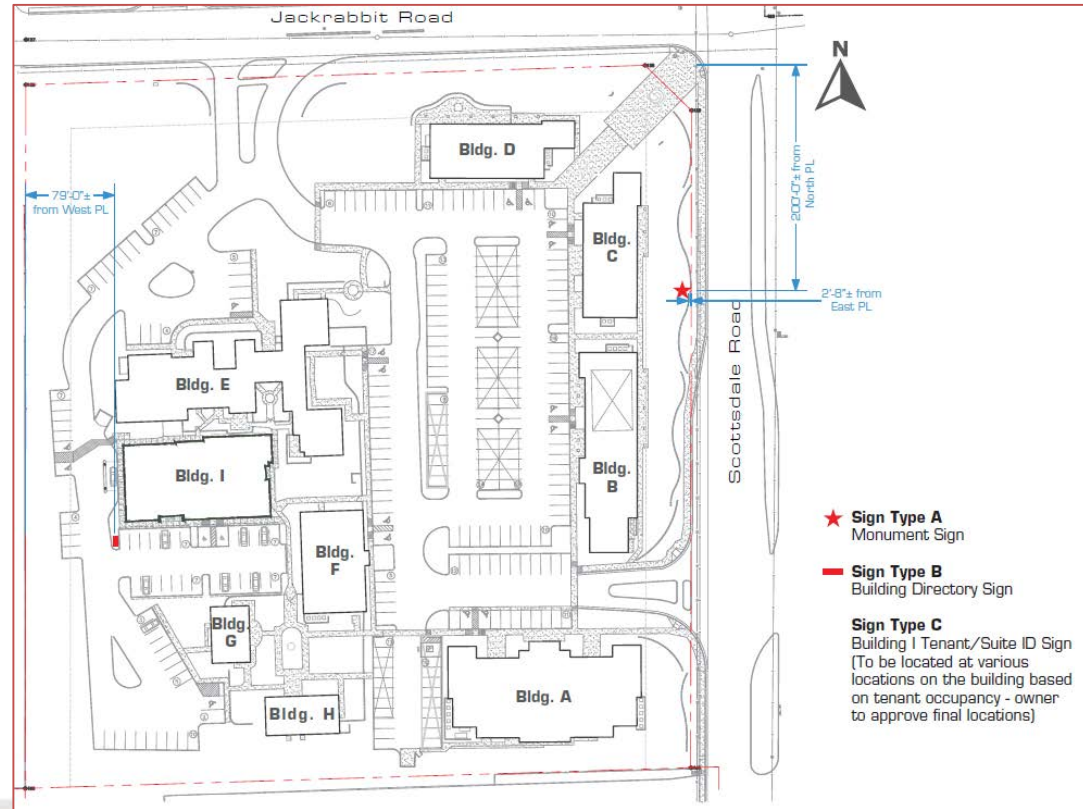

NEW MONUMENT SIGN

- Placed next to Scottsdale Road, near Building C
- Double-faced sign
- 8' tall and 8'4" wide (67.2 sq ft total area per side & 40 sq ft of copy per side)
- Finished to match buildings on campus
- Non-illuminated
- Identify address, name of plaza, and name of tenants

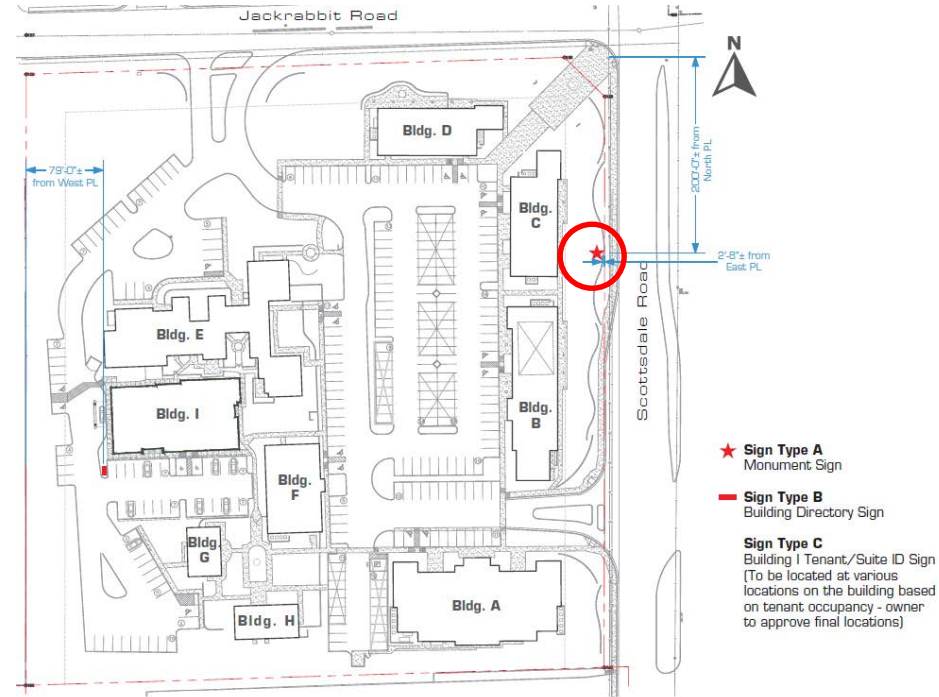

MONUMENT SIGN (CONT.)

- Existing Signs:
 - 2 wall mounted signs at each entrance
 - Combined area of 42 sq ft
- SUP Guidelines Recommend:
 - 1 ground sign at each entrance
 - Max 8' tall and no larger than 40 sq ft at each entrance
- New monument sign not placed at entrance and *exceeds* 40 sq ft limit
- Sign not illuminated and screened from western properties by existing buildings
- Reduced Tenant Names from 16 to 10

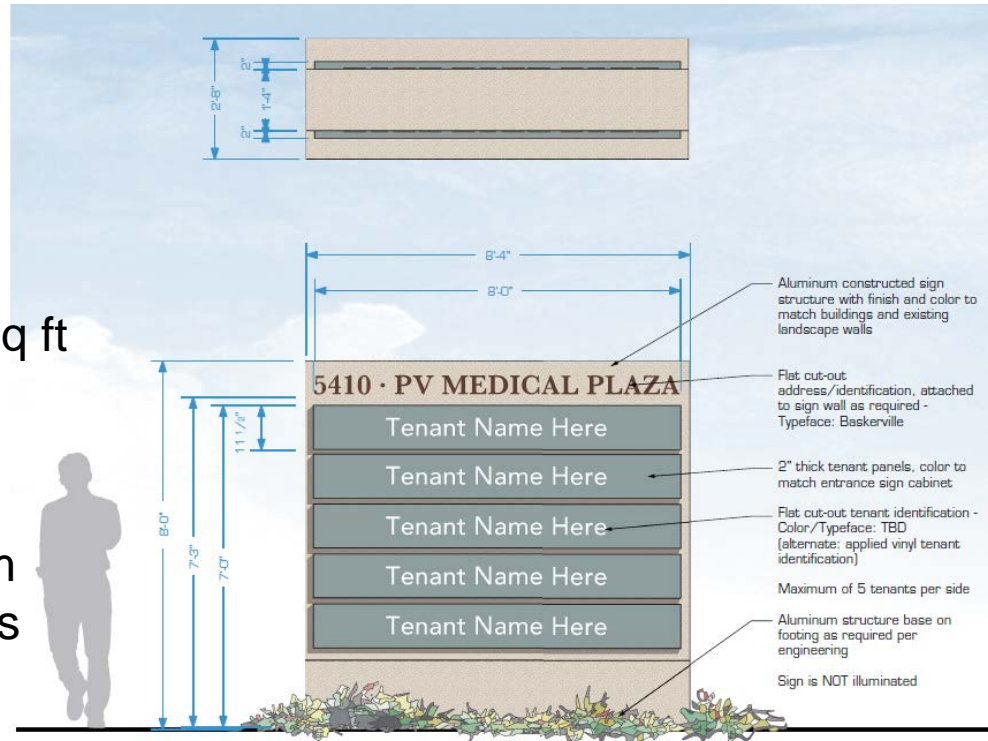

MONUMENT SIGN (CONT.)



Existing Conditions



Monument Sign Render

January 24, 2019

TENANT/DIRECTIONAL SIGNAGE

- Located between new medical building and new parking area
- Match existing directional signage on campus
- 5' tall and 4'6" wide (22.5 sq ft)
- Non-illuminated
- Identity tenant name and office/suite
- SUP Guidelines recommend 12 sq ft in and a 5' tall height
- Sign meets recommended height but exceeds the recommend size limit

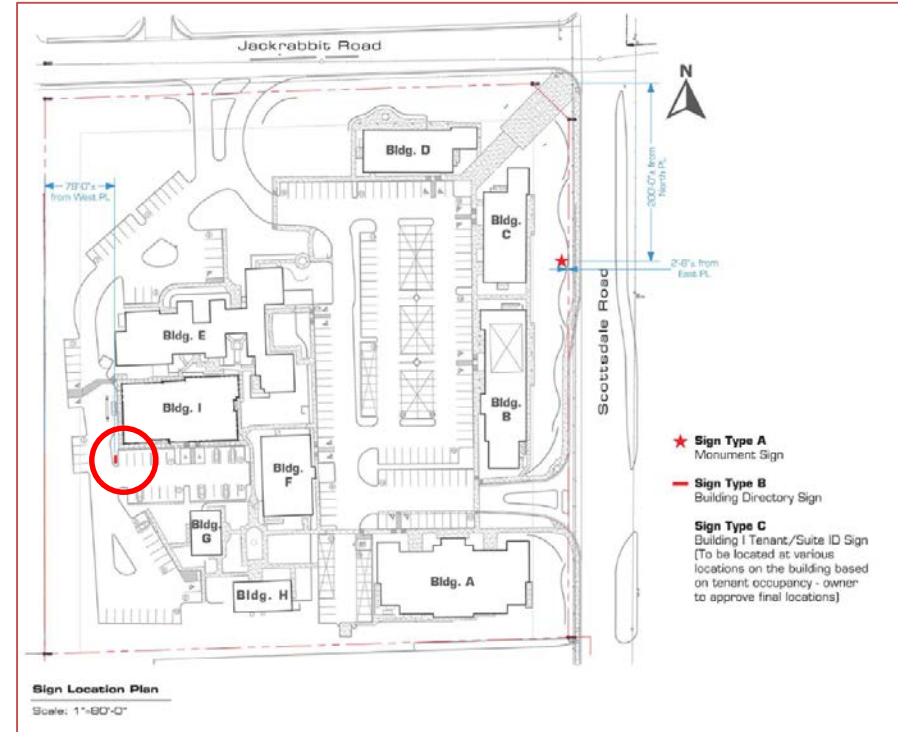

TENANT/DIRECTIONAL SIGNAGE

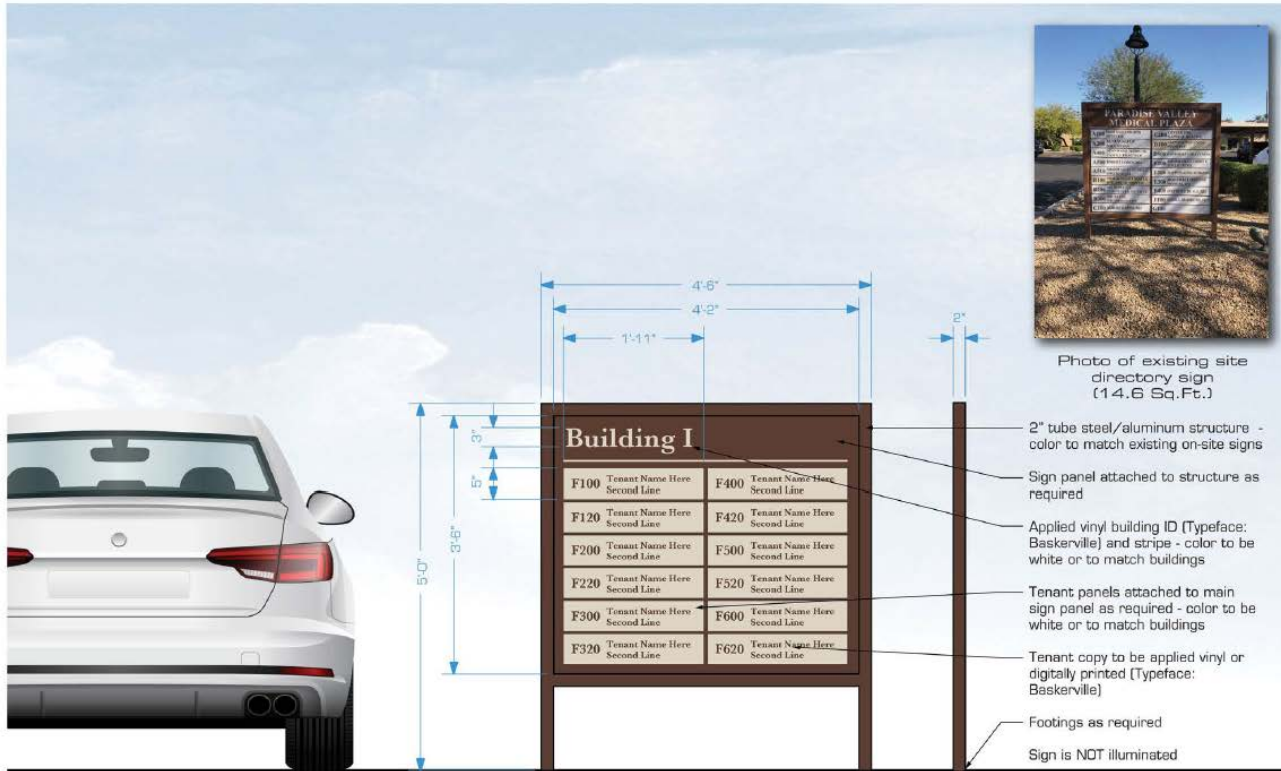

Sign Type B - Building Directory Sign

Scale: 3/4"=1'-0" Qty: 1 - 14.6 Sq.Ft.



TENANT I.D. SIGNAGE

- I.D. signs placed next to each office/suite
- Will match existing signs
- 1' tall and 2' wide (2 sq ft)
- Identify tenant name and suite number
- SUP Guidelines do not identify recommended size or height for tenant I.D. signs

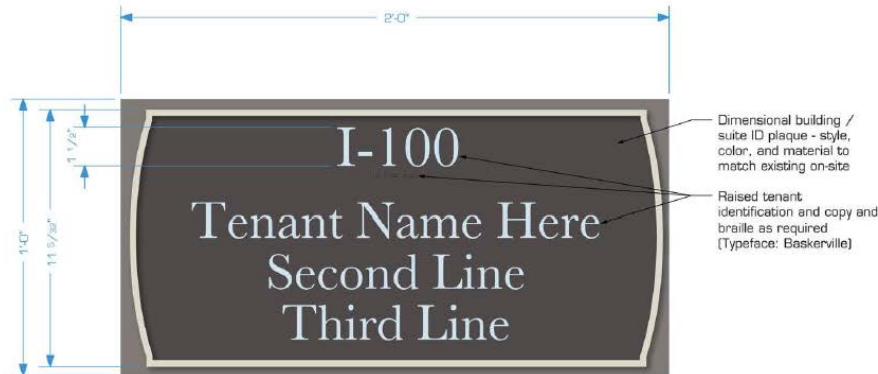

Sign Type C - Building | Tenant/Suite ID Sign

Scale: 3"=1'-0"

Qty: TBD - 2 Sq.Ft.



Photo of existing building / suite ID sign (2 Sq.Ft.)

January 24, 2019



BUILDING SIGNAGE

- Letter “I” will be placed on east and west elevations of building
- Non-illuminated
- Match existing building identifications signs
- SUP Guidelines do not identify a recommended size or height for building identification signs

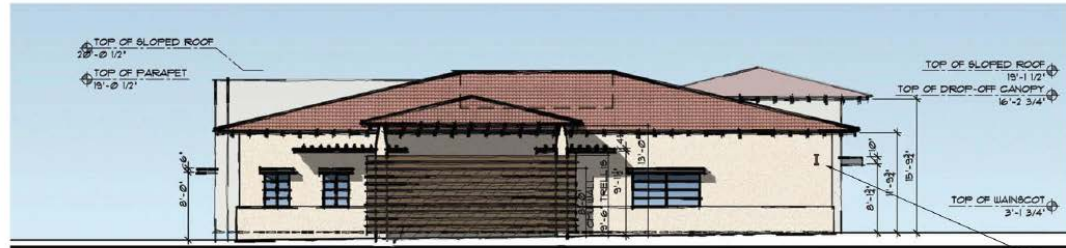

West Elevation

Dimensional building letter “I” identification on East and West elevations.

Color/Typeface to match existing identifications.



East Elevation

PUBLIC COMMENT

- 2 Neighbors in Support:
 - First Southern Baptist Church
 - Northwest Neighbor
- 2 Neighbors with Concerns:
 - Southern Neighbor
 - Western Neighbor
 - Concerns:
 - Drainage & On-site Retention
 - Patient Drop-Off Area
 - Hours of Operation
 - Traffic & Intensity of Use
 - Construction of Improvements (Timing & Duration)
 - Garbage Pick-Up, Landscape Maintenance, etc.

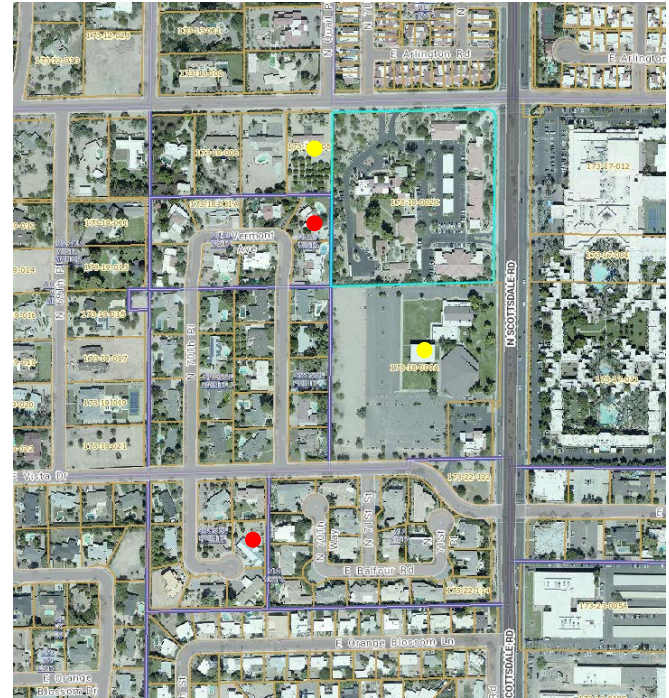

INTERMEDIATE SUP AMENDMENT

- Intermediate SUP Amendment:
 - Since adding more than 5,000 sq ft, request constitutes an Intermediate Amendment
 - Improvements match architecture of SUP
 - Improved patient drop-off with screen wall and roof
 - Monument sign located next to Scottsdale Rd and screened from west by existing bldgs.



ORDINANCE 2019-01

1. All improvements shall be in substantial compliance with Narrative and Plans
2. Property owner and Town shall sign and record a Waiver of Rights and Remedies agreement under A.R.S. § 12-1134 (Proposition 207 Waiver) in form provided by Town Attorney within 10 calendar days of approval of this SUP amendment
3. All existing SUP stipulations shall remain in full force and effect, unless changed or modified by Intermediate Amendment SUP-18-10.



NEXT STEPS

- February 14, 2019 TC Public Hearing:
 - Approve
 - Approve with stipulations (via Ordinance 2019-01)
 - Deny
 - Continue for further review



TODAY'S GOAL

- Input Regarding PV Medical Plaza Intermediate SUP Amendment

