



Smoke Tree Resort

Traffic Impact Analysis

7101 E. Lincoln Drive
Town of Paradise Valley, Arizona

November 2018
Project No. 18-0550

Prepared For:

Beus Gilbert, PLC
701 N. 44th Street
Phoenix, Arizona 85008

For Submittal to:

Town of Paradise Valley

Prepared By:



10605 North Hayden Road
Suite 140
Scottsdale, Arizona 85260
480-659-4250

SMOKE TREE RESORT TRAFFIC IMPACT ANALYSIS

7101 E Lincoln Drive
Town of Paradise Valley, Arizona

Prepared for:
Beus Gilbert PLLC
701 N 44th Street
Phoenix, Arizona 85008

For Submittal to:
Town of Paradise Valley

Prepared By:



CivTech, Inc.
10605 North Hayden Road
Suite 140
Scottsdale, Arizona 85260
(480) 659-4250



Expires 3-31-2019

November 2018

CivTech Project No. 18-0550

TABLE OF CONTENTS

EXECUTIVE SUMMARY	1
INTRODUCTION.....	1
EXISTING CONDITIONS	5
SURROUNDING LAND USE	5
EXISTING ROADWAY NETWORK	5
EXISTING INTERSECTION CONFIGURATION	5
EXISTING TRAFFIC VOLUMES	9
EXISTING CAPACITY ANALYSIS.....	11
PROPOSED DEVELOPMENT.....	13
SITE LOCATION	13
SITE ACCESS.....	13
TRIP GENERATION.....	15
TRIP DISTRIBUTION AND ASSIGNMENT	15
FUTURE BACKGROUND TRAFFIC.....	19
TOTAL TRAFFIC	19
TRAFFIC AND IMPROVEMENT ANALYSIS	24
INTERSECTION CAPACITY ANALYSIS.....	24
QUEUE LENGTH ANALYSIS	27
SIGHT DISTANCE ANALYSIS	28
CONCLUSIONS.....	30
LIST OF REFERENCES.....	32
TECHNICAL APPENDIX	33

LIST OF TABLES

Table 1: Level of Service Criteria.....	11
Table 2: Existing Peak Hour Levels of Service.....	12
Table 3: Trip Generation Summary.....	15
Table 4: Site Trip Distribution	16
Table 5: Growth Rate Expansion Factors	19
Table 6: Peak Hour Levels of Service.....	24
Table 7: Queue Storage Lengths	27
Table 8: AASHTO Sight Distance Requirements.....	28

LIST OF FIGURES

Figure 1 - Vicinity Map	4
Figure 2 - Existing Lane Configurations and Stop Control	8
Figure 3 - Existing Traffic Volumes	10
Figure 4 - Site Plan and Access	14
Figure 5 - Trip Distribution	17
Figure 6 - Site Generated Traffic Volumes	18
Figure 7 - 2020 Background Traffic Volumes	20
Figure 8 - 2025 Background Traffic Volumes	21
Figure 9 - 2020 Total Traffic Volumes.....	22
Figure 10 - 2025 Total Traffic Volumes.....	23
Figure 11 - Proposed Lane Configurations and Traffic Control.....	26

EXECUTIVE SUMMARY

This report documents a traffic impact analysis performed for the proposed Smoke Tree Resort south of Lincoln Road between Mockingbird Lane and Scottsdale Road in the Town of Paradise Valley. The proposed development will consist of maximum of 150 hotel rooms and a maximum of 30 residential units of 1,200 SF each above the hotel rooms.

CivTech, Inc. has been retained by Beus Gilbert PLLC to perform the traffic impact study for the proposed redevelopment. The purpose of this assessment is to address the traffic and transportation impacts of the proposed development on the surrounding streets and intersections.

The following conclusions have been documented in this study.

Existing Conditions

- The results of the existing conditions analysis indicates that all intersections currently operate at an overall acceptable level of service (LOS D or better), with the exception of the intersections of Apartment Driveway & Lincoln Drive and AJ's Driveway & Lincoln Drive under the existing lane configurations.
 - The intersections of **Apartment Driveway & Lincoln Drive and AJ's Driveway & Lincoln Drive** experience delays in the northbound left turn approach and southbound left turn. Both of these approaches and driveways are driveways for AJ's Fine Foods and existing Apartments. It is possible that a raised median will be installed along the length of Lincoln Drive.

Opening Year 2020 and Horizon Year 2025

- The results of the Synchro analysis indicates that all study intersections are anticipated to experience an acceptable level of service, with the exception of the intersections of **Apartment Driveway & Lincoln Drive, AJ's Driveway & Lincoln Drive, and Scottsdale Road & Lincoln Drive.**
 - The intersections of **Apartment Driveway & Lincoln Drive and AJ's Driveway & Lincoln Drive** experience delays in the northbound left turn approach and southbound left turn. Both of these approaches and driveways are driveways for AJ's Fine Foods and the existing Lincoln Apartments. The addition of Lincoln Medical Center is not the cause of these delays, which remains consistent with the existing condition. It is possible that a raised median will be installed along the length of Lincoln Drive. If this is true, then these movements would be restricted and no longer cause delay.
 - The intersection of **Scottsdale Road & Lincoln Drive** is expected to experience delay on the eastbound and westbound approaches during

both the AM and PM peak hours for both the 2020 and 2025 horizon years. The intersection operates at an acceptable level of service overall, except during the AM peak hour of the 2025 full build scenario, however, this delay is only 55.4 seconds which is just over the threshold of an acceptable level of service. Since the City of Scottsdale is planning on reconfiguring the intersection in the future, no mitigation measures for this intersection will be taken or are recommended at this time.

- The intersection of **Quail Run Road and Access A** reports a delay of zero seconds using the HCM 6th edition methodology. No LOS is reported in the included appendices, however zero seconds of delay would yield an LOS of A, shown in the table.

Queue Storage and Sight Distance

- According to the CivTech study done for the Ritz Carlton, the newly signalized intersection of Quail Run Road and Lincoln Drive will have eastbound/westbound left turn lanes and a westbound right turn lane striped with 150 feet of storage each. While 150 feet is being proposed due to the current development agreement with Five Star Development for the Ritz Carlton, less is required to meet the recommended AASHTO length. The recommended storage lengths are provided for horizon year 2025 using the total traffic projections.
- There are no existing obstructions to sight distance within the project intersections or along the included corners of the proposed intersection. Adequate site distance must be provided at the intersections to allow safe left and right turning movements from the development
 - The contractor should ensure that sight visibility is provided at all proposed intersections according to the distances and that sight triangles at public intersections are maintained according to the Town Code. All vegetation and trees should be maintained according to Town of Paradise Valley regulations.
- Smoke Tree Resort is requesting a full access at its eastern most entrance anticipating that the addition of a median will restrict the western most driveway to a right in/right out.
 - The required westbound left turn storage requirement for this movement is 50 feet, which is the minimum requirement based on AASHTO standards.
 - The design would require an exception to the standard 90 foot taper length in order to provide the required queue for the back to back left turns.
- Should all driveways for Smoke Tree Resort be restricted to right in/right out only, the proposed Access A on Quail Run Road would be highly utilized for vehicles egressing the site and travelling west or vehicles entering the site from the east.

INTRODUCTION

Smoke Tree Resort is currently 26 individual suites and bungalows. The site is being redeveloped and is proposed as a hotel with a maximum of 150 hotel rooms and a maximum of 30 residential units of 1,200 SF each above the hotel rooms. The site is located on the south side of Lincoln Drive between Mockingbird Lane and Scottsdale road.

Study Requirements

This study analyzes the traffic impact due to the proposed development on the surrounding street network. The study will be prepared in conformance with the Town of Paradise Valley's Traffic Impact Analysis (TIA) Criteria and Traffic Impact Statement (TIS) Criteria, May 2015. The specific objectives of the study are:

- ◆ To determine whether the planned street system in the vicinity of the site is adequate to accommodate the increased traffic that results from the proposed development.
- ◆ To recommend additional street improvements or traffic control devices, where necessary, and to mitigate the additional site-generated traffic

Study Area

This study is classified as a Category 1 TIA meaning the study area is defined as all signalized and major unsignalized intersections within a ¼ -mile radius of the site. The following study area intersections have been evaluated:

- Mockingbird Lane & Lincoln Drive
- Quail Run Road & Lincoln Drive
- Smoke Tree Driveway West & Lincoln Drive
- Smoke Tree Driveway East & Lincoln Drive
- Medical Office Driveway West & Lincoln Drive
- Medical Office Driveway East & Lincoln Drive
- Apartment Driveway & Lincoln Drive
- AJ's Driveway & Lincoln Drive
- Scottsdale Road & Lincoln Drive

Horizon Years

Per the study requirements, a Category 1 Traffic Impact and Mitigation Analysis is required. Analysis will be conducted on the current conditions, the opening year and opening plus five years.

It is assumed that development will open in October 2020. For purposes of this study, the development will be assumed fully built out by 2020. Therefore, the analysis years to be analyzed for this study include opening year 2020 and horizon year 2025. A location map of the study area is provided in **Figure 1**.

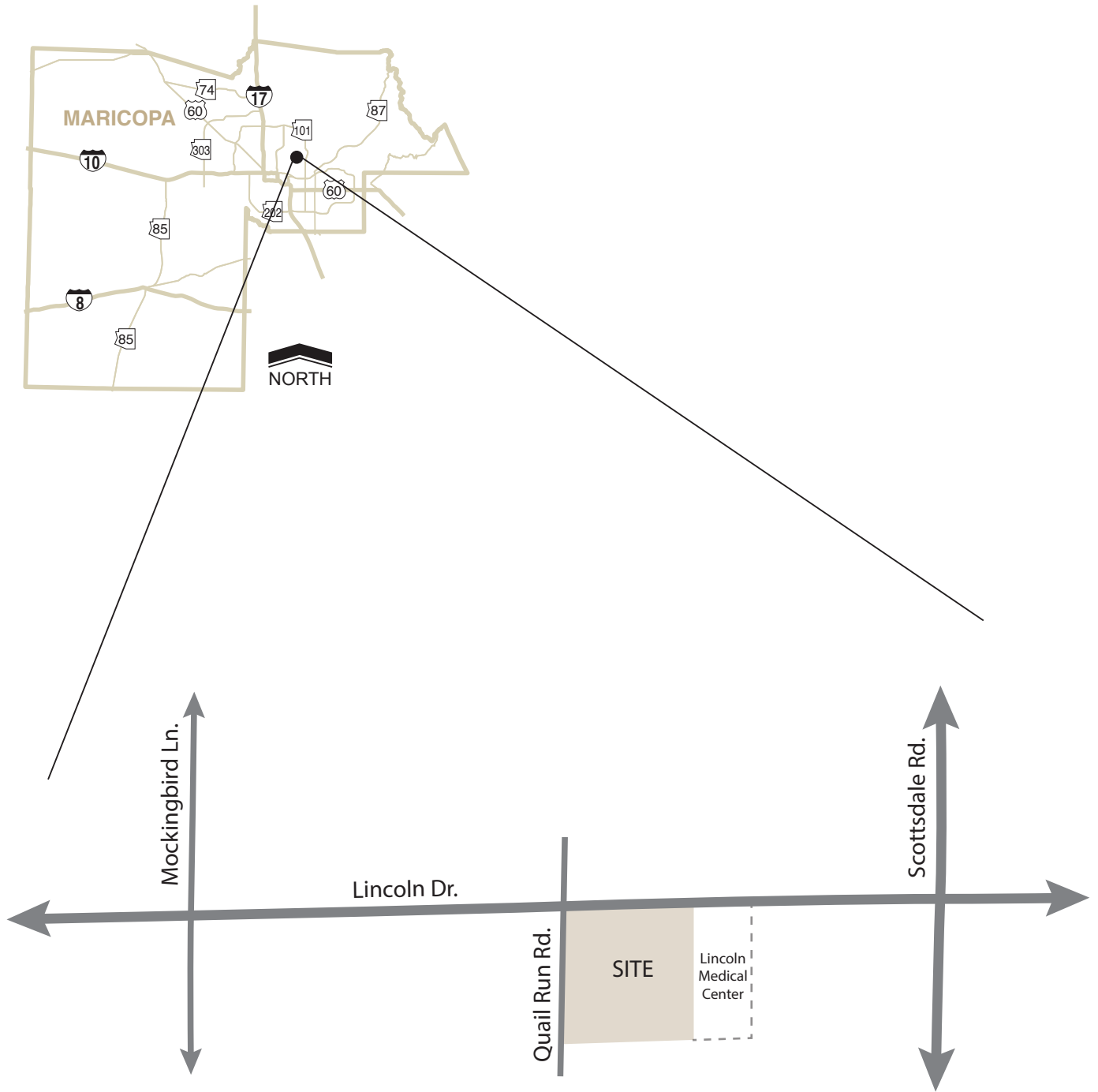

Figure 1: Vicinity Map

EXISTING CONDITIONS

SURROUNDING LAND USE

The surrounding area includes various land uses. Directly north of the site, on the north side of Lincoln Drive, is the site for the new Ritz Carlton luxury hotel. Bordering the site to the east is the site for the proposed Lincoln Medical Center expansion. West of the site are detached single-family homes. Northeast of the site is the Lincoln Scottsdale, multi-family apartment homes. Also within the vicinity of the site are many retail shops and restaurants.

EXISTING ROADWAY NETWORK

The existing roadway network analyzed in this study includes Mockingbird Lane, Lincoln Drive, Quail Run Road and Scottsdale Road.

Mockingbird Lane is a north-south three-lane road with one lane in each travelling direction and a continuous two-way-left-turn lane north of Lincoln Drive, and a two-lane road south of Lincoln Drive. Mockingbird Lane begins at the intersection with McDonald Road and continues north for approximately 2 miles before terminating at the intersection with Northern Avenue. The posted speed limit is 35 miles per hour (mph).

Lincoln Drive is an east-west four-lane road with two lanes in each travelling direction. Within the vicinity of the site, there are raised medians along portions of the road. Lincoln Drive begins just east of the State Route 51 freeway and continues east for approximately 7 miles before terminating at the intersection with Cattletrack Road, just west of the Arizona Canal. The posted speed limit is 35 mph within the vicinity of the site.

Quail Run Road is a north-south two-lane road with one lane in each travelling direction. Quail Run Road begins just north of a private property south of the site and continues north for approximately 0.15 miles before terminating at the intersection with Lincoln Drive. There is no posted speed limit.

Scottsdale Road is a north-south six-lane road with three lanes in each travelling direction within the vicinity of the site. There are broken, raised medians along the whole length of road. Scottsdale Road begins at the intersection with Rio Salado Parkway and continues north for approximately 18 miles before terminating at the intersection with Carefree Highway. The posted speed limit is 45 mph.

EXISTING INTERSECTION CONFIGURATION

The intersection of **Mockingbird Lane and Lincoln Drive** is a four-legged signalized intersection with protected left turns on the southbound and westbound approaches. The northbound and southbound approaches each have one dedicated left turn lane and a shared through and right turn lane. The eastbound and westbound approaches each have one dedicated left turn lane, one through lane, and one shared through and right turn lane. There are pedestrian crosswalks across all legs of the intersection.

The intersection of **Quail Run Road and Lincoln Drive** is a four-legged, stop-controlled intersection with free movements in the east and west directions. The northbound approach has one shared left turn/through/right turn lane. The eastbound approach has one through lane and one shared through and right turn lane. The westbound approach has two through lanes and a break in the median to allow for dedicated left turns. The southbound approach is currently a construction access point with one shared left turn/through/right turn lane.

The intersection of **Smoke Tree Driveway West and Lincoln Drive** is a three-legged, stop-controlled “T” intersection with free movements in the east and west directions. The northbound approach has one shared left turn and right turn lane. The eastbound approach has one through lane and one shared through and right turn lane. The westbound approach has two through lanes and a break in the median to allow for dedicated left turns.

The intersection of **Smoke Tree Driveway East and Lincoln Drive** is a three-legged, stop-controlled “T” intersection with free movements in the east and west directions. The northbound approach has one shared left turn and right turn lane. The eastbound approach has one through lane and one shared through and right turn lane. The westbound approach has two through lanes and a break in the median to allow for dedicated left turns.

The intersection of **Medical Office Driveway West and Lincoln Drive** is a three-legged, stop-controlled “T” intersection with free movements in the east and west directions. The northbound approach has one shared left turn and right turn lane. The eastbound approach has one through lane and one shared through and right turn lane. The westbound approach has two through lanes and a break in the median to allow for dedicated left turns.

The intersection of **Medical Office Driveway East and Lincoln Drive** is a three-legged, stop-controlled “T” intersection with free movements in the east and west directions. The northbound approach has one shared left turn and right turn lane. The eastbound approach has one through lane and one shared through and right turn lane. The westbound approach has two through lanes and a break in the median to allow for dedicated left turns.

The intersection of **Apartment Driveway and Lincoln Drive** is a four-legged, stop-controlled intersection with free movements in the east and west directions. The southbound approach consists of one dedicated left turn lane and one dedicated right turn lane. The eastbound approach consists of a two-way-left turn lane one through lane and one shared through and right turn lane. The northbound approach consists of one shared left turn and right turn lane. The westbound approach consists of a two-way left turn lane, on through lane and one shared through and right turn lane.

The intersection of **AJ’s Driveway and Lincoln Drive** is a four-legged, stop-controlled intersection with free movements in the east and west directions. The northbound approach has one shared left turn and right turn lane. The eastbound approach has a

two-way-left-turn lane, one through lane and one shared through and right turn lane. The southbound approach has one dedicated left turn lane and one dedicated right turn lane. The westbound approach has a dedicated left turn lane, one through lane and one shared through and right turn lane.

The intersection of **Scottsdale Road and Lincoln Drive** is a four-legged signalized intersection with split phasing on the eastbound and westbound approaches and protected left turns on the northbound and southbound approaches. The northbound approach has two dedicated left turn lanes, two through lanes and one shared through and right turn lane. The westbound approach has one dedicated left turn lane, one through lane and one shared through and right turn lane. The southbound approach has one dedicated left turn lane, three through lanes and one dedicated right turn lane. The eastbound approach has one dedicated left turn lane, one shared left turn and through lane and one dedicated right turn lane. There are pedestrian cross walks across all legs of the intersection.

The existing intersection configurations and traffic control is illustrated in **Figure 2**.

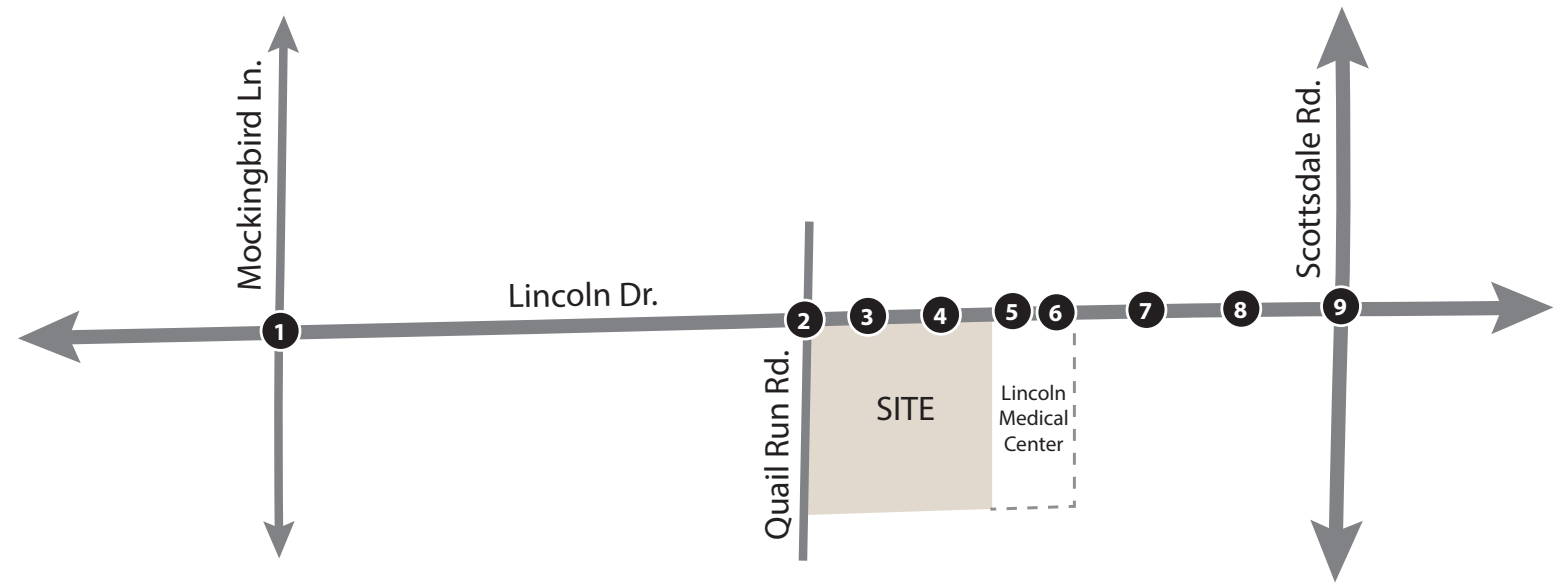
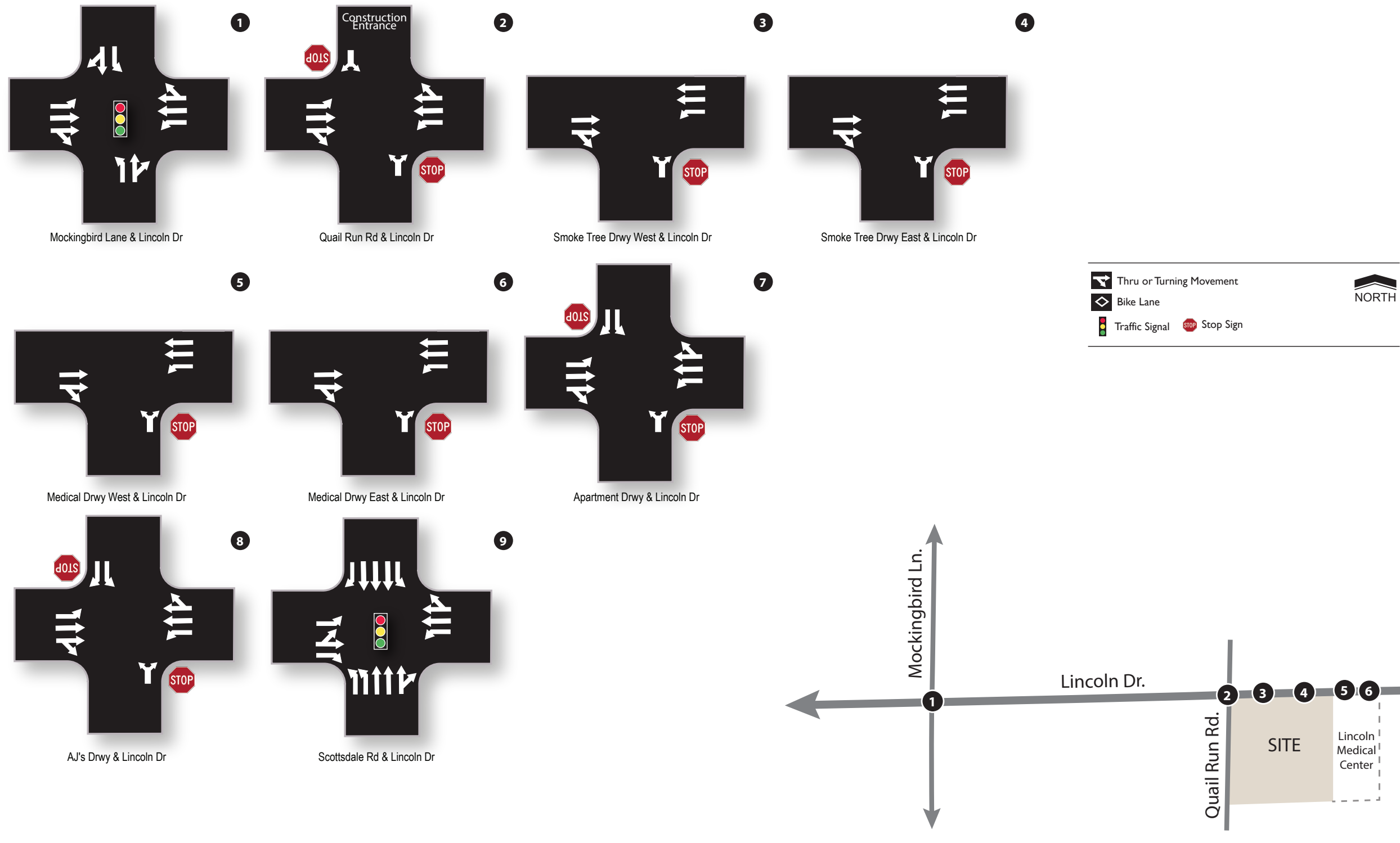

Figure 2: Existing Lane Configurations and Traffic Controls

EXISTING TRAFFIC VOLUMES

CivTech engaged Field Data Services of Arizona, Inc. to record traffic volumes at nine study intersections within the project vicinity. Peak hour volume turning movement counts were performed from 7:00-9:00 AM and 4:00-6:00 PM on Thursday, May 31, 2018. Peak hour turning movement counts were conducted at the following study intersections:

- Mockingbird Lane & Lincoln Drive
- Quail Run Road & Lincoln Drive
- Smoke Tree Driveway West & Lincoln Drive
- Smoke Tree Driveway East & Lincoln Drive
- Medical Office Driveway West & Lincoln Drive
- Medical Office Driveway East & Lincoln Drive
- Apartment Driveway & Lincoln Drive
- AJ's Driveway & Lincoln Drive
- Scottsdale Road & Lincoln Drive

The Town of Paradise Valley requires that a seasonal adjustment factor be applied to existing traffic counts taken outside of typical months. These traffic counts were conducted in May, and summer months typically have lower amounts of traffic due to school not being in session. The seasonal adjustment factor for the month of May is 1.01, however since they were conducted on the last day of the month, the adjustment factor for the month of June will be used to be more conservative. The seasonal adjustment factor for June is 1.03, this was applied to all traffic within the study area. Existing 2018 traffic volumes with the seasonal adjustment factor applied are presented in **Figure 3** for the weekday AM and PM peak hours. Raw traffic volume data obtained for this study have been included in **Appendix B**.

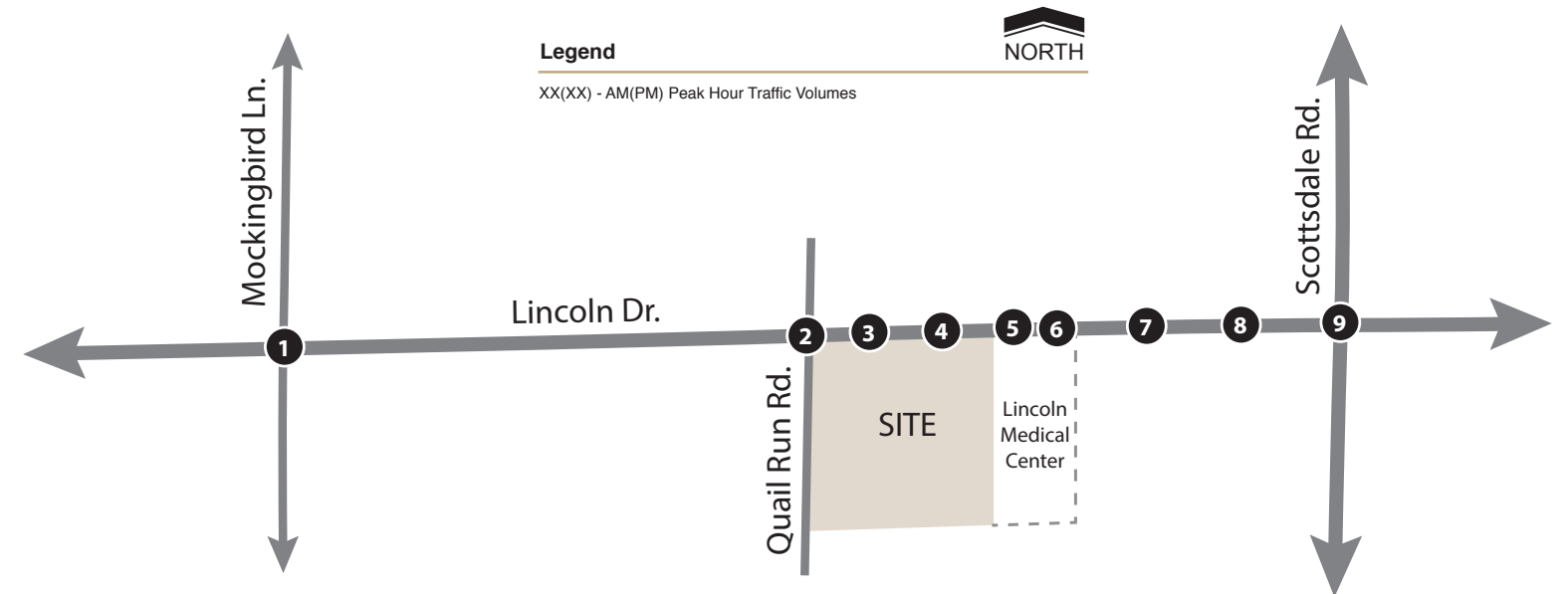
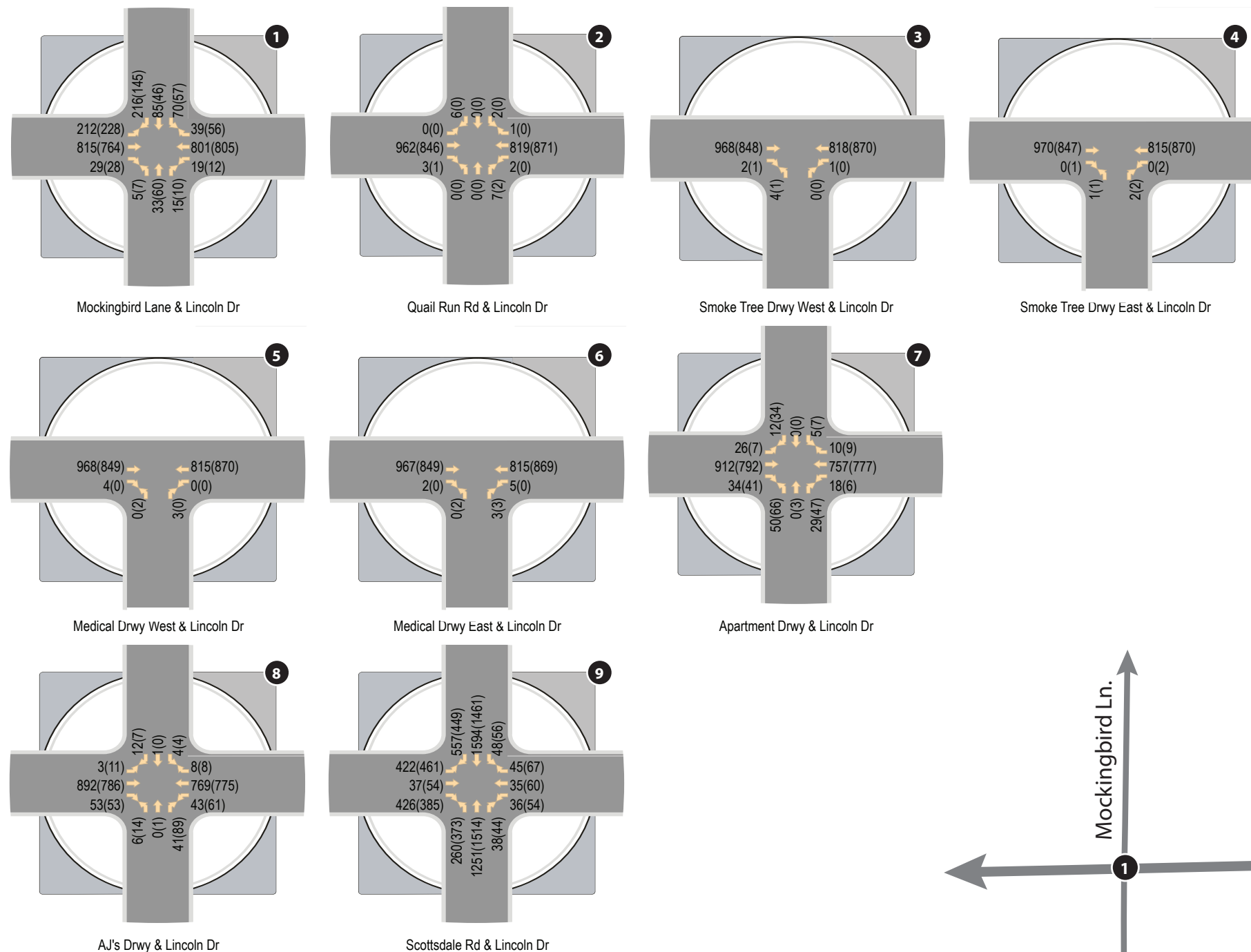

Figure 3: Seasonally Adjusted Existing Traffic Volumes

EXISTING CAPACITY ANALYSIS

Peak hour capacity analyses have been conducted for the study intersections based on existing intersection configurations and traffic volumes. All intersections have been analyzed using the methodologies presented in the *Highway Capacity Manual (HCM)*, *Special Report 209*, and Updated 2016 and using Synchro software, version 10.0 under the HCM 6th edition methodology.

The concept of level of service (LOS) uses qualitative measures that characterize operational conditions within the traffic stream. The individual levels of service are described by factors that include speed, travel time, freedom to maneuver, traffic interruptions, and comfort and convenience. Six levels of service are defined for each type of facility for which analysis procedures are available. They are given letter designations A through F, with LOS A representing the best operating conditions and LOS F the worst. Each level of service represents a range of operating conditions. Levels of service for intersections are defined in terms of delay ranges. **Table 1** lists the level of service criteria for signalized and unsignalized intersections, respectively.

Table 1: Level of Service Criteria

Level of Service	Control Delay (seconds/vehicle)	
	Signalized Intersections	Unsignalized Intersections
A	≤ 10	≤ 10
B	> 10-20	> 10-15
C	> 20-35	> 15-25
D	> 35-55	> 25-35
E	> 55-80	> 35-50
F	> 80	> 50

Source: Exhibit 19-8, Exhibit 20-2, Exhibit 21-8 and Exhibit 22-8, Highway Capacity Manual 2017

Synchro 10.0 software calculates the LOS per the HCM 6th edition methodology. The 6th edition HCM documents the signalized LOS calculation methodology which takes into account lane geometry, traffic volumes and cycle length/phasing to compute LOS. Synchro analysis worksheets report individual movement delay/LOS and overall delay/LOS for signalized intersections; unsignalized intersection worksheets report the worst-case delay/LOS and the average overall intersection delay. Signal timing data for the intersection of Mockingbird Lane and Lincoln Drive was provided by the Town of Paradise Valley. Timing for the intersection of Scottsdale Road and Lincoln Drive was provided by the City of Scottsdale. Results of the existing level of service analyses are shown in **Table 2** for both AM and PM peak hours. The existing conditions analysis worksheets have been included in **Appendix C**.

Table 2: Existing Peak Hour Levels of Service

ID	Intersection	Intersection Control	Approach/Movement	Existing LOS AM (PM)
1	Mockingbird Lane & Lincoln Drive	Signal	NB	D(E)
			SB	E(E)
			EB	B(A)
			WB	B(B)
			Overall	C(B)
2	Quail Run Road & Lincoln Drive	2-way stop (NB/SB)	NB Shared	B(B)
			SB Shared	C(A)
			EB Left	A(A)
			WB Left	B(A)
3	Smoke Tree Driveway West & Lincoln Drive	1-way stop (NB)	NB Shared	C(C)
			WB Left	B(A)
4	Smoke Tree Driveway East & Lincoln Drive	1-way stop (NB)	NB Shared	C(B)
			WB Left	A(A)
5	Medical Driveway West & Lincoln Drive	1-way stop (NB)	NB Shared	B(C)
			WB Left	A(A)
6	Medical Driveway West & Lincoln Drive	1-way stop (NB)	NB Shared	B(C)
			WB Left	B(A)
7	Apartment Driveway & Lincoln Drive	2-way stop (NB/SB)	NB Shared	F(F)
			SB Left	F(E)
			SB Right	B(B)
			EB Left	A(A)
			WB Left	B(A)
8	AJ's Driveway & Lincoln Drive	2-way stop (NB/SB)	NB Shared	C(D)
			SB Left	F(F)
			SB Right	B(B)
			EB Left	A(A)
			WB Left	B(B)
9	Scottsdale Road & Lincoln Drive	Signal	NB	C(C)
			SB	D(C)
			EB	E(E)
			WB	E(F)
			Overall	D(D)

The results of the existing conditions analysis summarized in **Table 2** indicates that all intersections currently operate at an overall acceptable level of service (LOS D or better), with the exception of the intersections of Apartment Driveway & Lincoln Drive and AJ's Driveway & Lincoln Drive under the existing lane configurations depicted in **Figure 2**.

The intersections of **Apartment Driveway & Lincoln Drive** and **AJ's Driveway & Lincoln Drive** experience delays in the northbound left turn approach and southbound left turn. Both of these approaches and driveways are driveways for AJ's Fine Foods and existing Apartments. It is possible that a raised median will be installed along the length of Lincoln Drive.

PROPOSED DEVELOPMENT

SITE LOCATION

The proposed redevelopment will be located 7101 East Lincoln Drive in the Town of Paradise Valley, Arizona.

SITE ACCESS

There are three access points proposed for this development, described as follows:

- The West Access is an existing full movement driveway on the eastern border of the Smoke Tree Resort property. By opening year 2020, this access point will be restricted to a right in/right out driveway only. This access will become restricted via a raised median proposed by the Town of Paradise Valley.
- The East Access is an existing full movement driveway on the western border of the Smoke Tree Resort property. This access will remain full access upon completion of the project.
- Access A is a proposed access from Quail Run Road to the Smoke Tree site. The intersection of Quail Run Road and Lincoln Drive will be signalized by build out year 2020, and it is expected that some vehicles will utilize Quail Run Road to access the Smoke Tree site. This access will be a full movement access on the western border of the site.

The proposed site plan is provided in **Figure 4**.



Figure 4: Site Plan and Access

TRIP GENERATION

The potential trip generation for the proposed development was estimated utilizing the Institute of Transportation Engineers (ITE) *Trip Generation Manual, 10th Edition* and *Trip Generation Handbook, 3rd Edition*. The ITE *Trip Generation Manual* contains data collected by various transportation professionals for a wide range of different land uses. The data are summarized in the report and average rates and equations have been established that correlate the relationship between an independent variable that describes the development size and generated trips for each categorized land use. The report provides information for daily and peak hour trips.

Since the Smoke Tree Resort is a proposed redevelopment of the current resort, some of the existing traffic counts are existing trips generated by the site. To be conservative, these trips were not subtracted from the existing traffic counts, meaning that there will actually be less “new trips” than mentioned in this study.

The proposed development will consist of a maximum of 150 standard hotel rooms, 30 residential units/condos and a 3,500 square foot quality restaurant. The restaurant will be on the resort site, but is not intended to serve guests of the resort completely. An internal capture reduction reduces the number of external trips being made to the site. It is assumed that approximately 50% of all visitors to the restaurant will be off site and the other 50% will be guests and residents of the resort. **Table 3** depicts the trip generation summary for the proposed development. Trip generation calculations are provided in **Appendix D**.

Table 3: Trip Generation Summary

Proposed Use	ITE LUC	Size	Units	Weekday Trips						
				Daily	AM			PM		
					Total	In	Out	Total	In	Out
Hotel	310	150	Rooms	778	42	17	59	32	43	75
Condos	220	30	Dwelling Units	186	3	12	15	13	7	20
Quality Restaurant	931	3,500	SF	294	0	3	3	18	9	27
Total Trips				1,258	45	32	77	63	59	122
<i>Internal Capture Reduction (Quality Restaurants 50%)</i>				<i>(148)</i>	<i>(0)</i>	<i>(2)</i>	<i>(2)</i>	<i>(9)</i>	<i>(5)</i>	<i>(14)</i>
Subtotals				1,110	45	30	75	54	54	108

As shown in **Table 3**, the proposed development is anticipated to generate approximately 1,110 weekday daily trips, with 75 trips occurring in the AM peak hour and 108 trips occurring in the PM peak hour.

TRIP DISTRIBUTION AND ASSIGNMENT

A single trip distribution pattern was assumed for the proposed development. It is expected that the resort development will generate trips based on future population

within a 7-mile radius of the site. Future total population within a 7-mile radius of the site, as predicted by the 2020/2030 socio-economic data compiled by the Maricopa Association of Governments (MAG), was used as a basis to estimate trip distribution for the resort development

The resulting trip distribution percentages for the study area are shown in **Table 4**. The trip distribution calculations are included in **Appendix E**.

Table 4: Site Trip Distribution

Direction (To/From)	Trip Distribution
North on Mockingbird Ln	6%
South on Mockingbird Ln	4%
West on Lincoln Dr	25%
North on Scottsdale Rd	35%
South on Scottsdale Rd	30%
Total	100%

Figure 5 illustrates the trip distribution percentages shown in **Table 4** on the existing roadway network with the study area. The percentages presented in **Figure 5** were applied to the site trips generated to determine the AM and PM peak hour site traffic at the intersections within the study area. The resulting site generated traffic for the proposed development are presented in **Figure 6**.

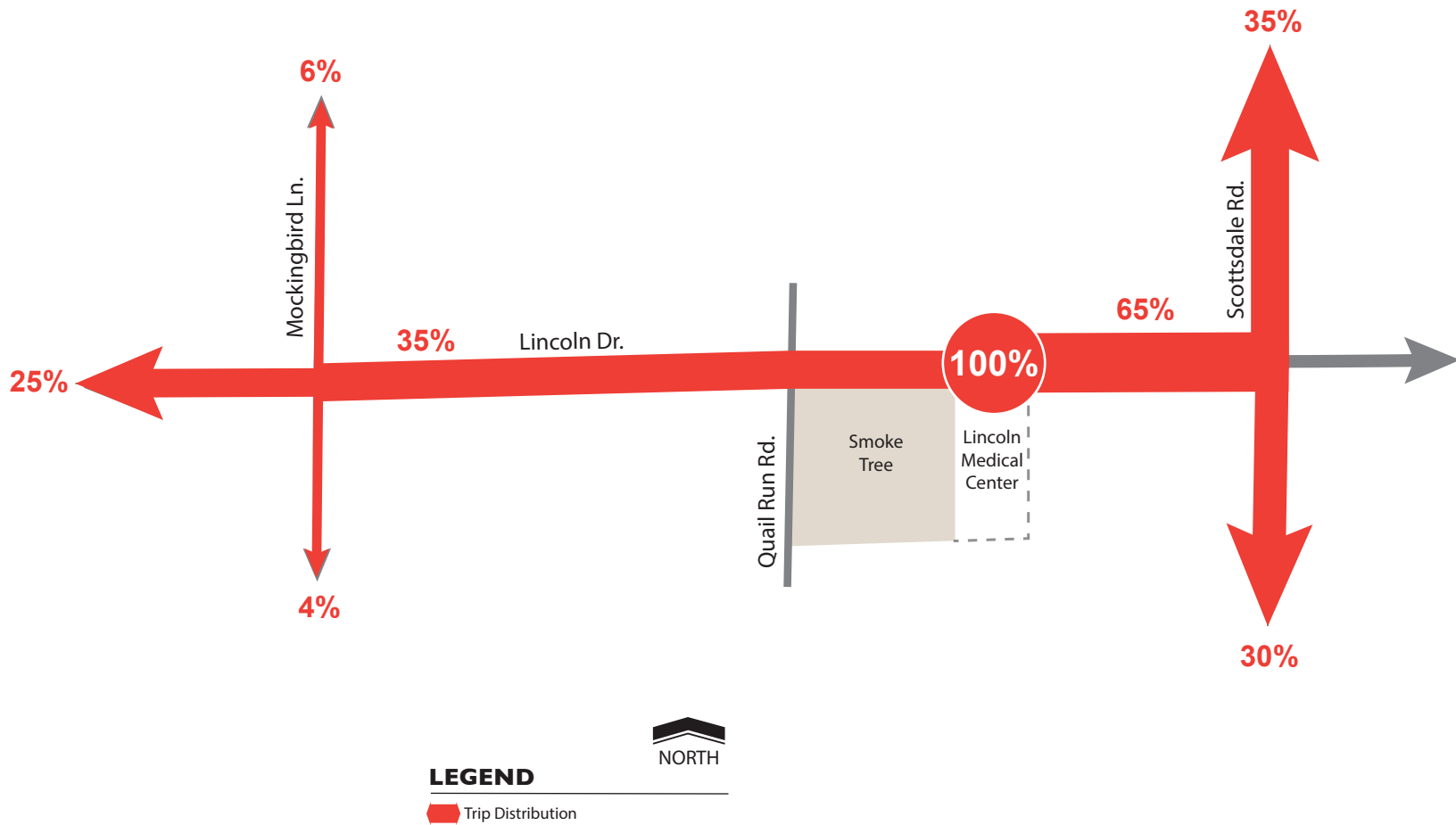

Figure 5: Trip Distribution

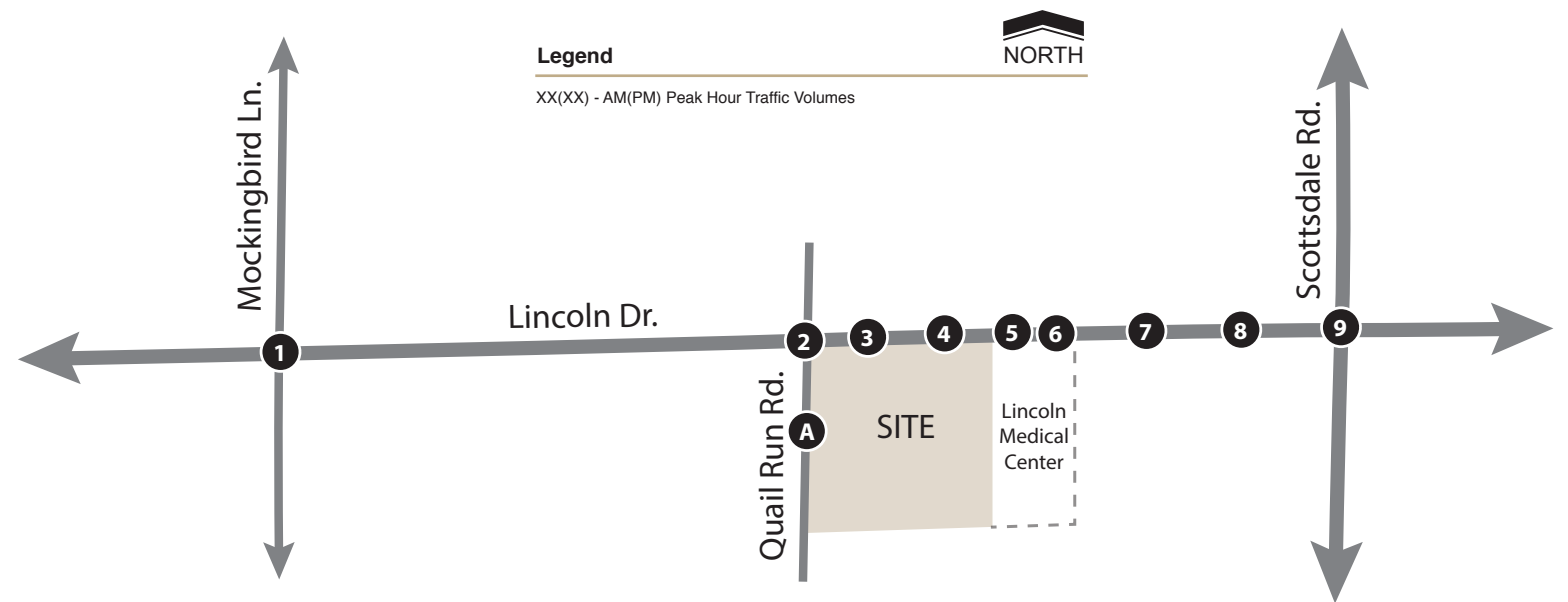
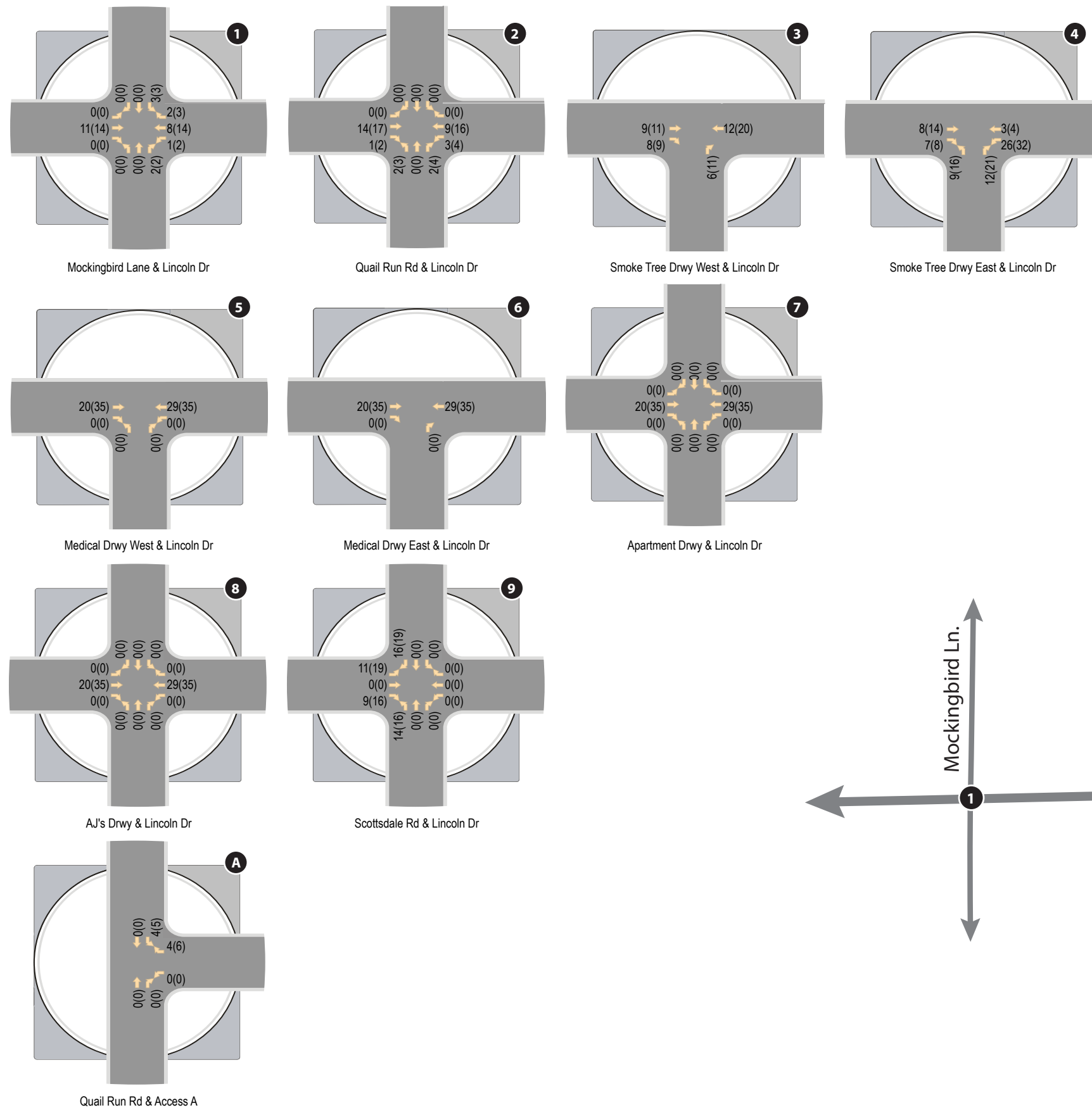

Figure 6: Site Generated Traffic Volumes

FUTURE BACKGROUND TRAFFIC

CivTech applied a growth rate to the seasonally adjusted traffic counts for this study in order to obtain the background traffic volumes along the adjacent roadway network. In reviewing the City of Scottsdale Traffic Counts Map, a 1.7% average growth rate was found within the proposed study area. **Table 5** shows the expansion factors used for the proposed opening year 2020 and horizon year 2025.

Table 5: Growth Rate Expansion Factors

Horizon Year	Expansion Factor
2020	1.034
2025	1.125

Applying the growth rate expansion factors to the seasonally adjusted existing traffic volumes predicts the volume of traffic anticipated on the surrounding area roads for opening year 2020 and horizon year 2025. Directly north of the proposed Smoke Tree Resort is the new Ritz Carlton Resort. Phase 1 of that development is expected to be open by 2020, meaning that it will be adding some site generated trips to the surrounding roadway network. Since CivTech was the company that performed the analysis for the Ritz Carlton in 2015, the site generated volumes expected for 2020 and 2025 were added to the grown existing volumes. Directly east of the proposed site is another proposed development, Lincoln Medical Center. It is expected that the Lincoln Medical expansion and the Smoke Tree Resort will begin and end construction at roughly the same time. Lincoln Medical Center is also expected to add additional traffic to the surrounding roadway network. The proposed site generated trips were assigned to the surrounding roadway network, and these trips were also added to the grown existing volumes.

The same methodology was used for both horizon years. Calculated background traffic for opening year 2020 and horizon year 2025 is presented in **Figure 7** and **Figure 8**, respectively. Seasonally adjusted existing traffic volumes, Ritz Carlton site volumes, Smoke Tree site volumes and more detailed background traffic calculations are included in **Appendix F**.

TOTAL TRAFFIC

Total traffic was determined by adding the site generated traffic to the projected background traffic. Total peak hour traffic volumes for the opening year 2020 and horizon year 2025 are shown in **Figure 9** and **Figure 10**, respectively.

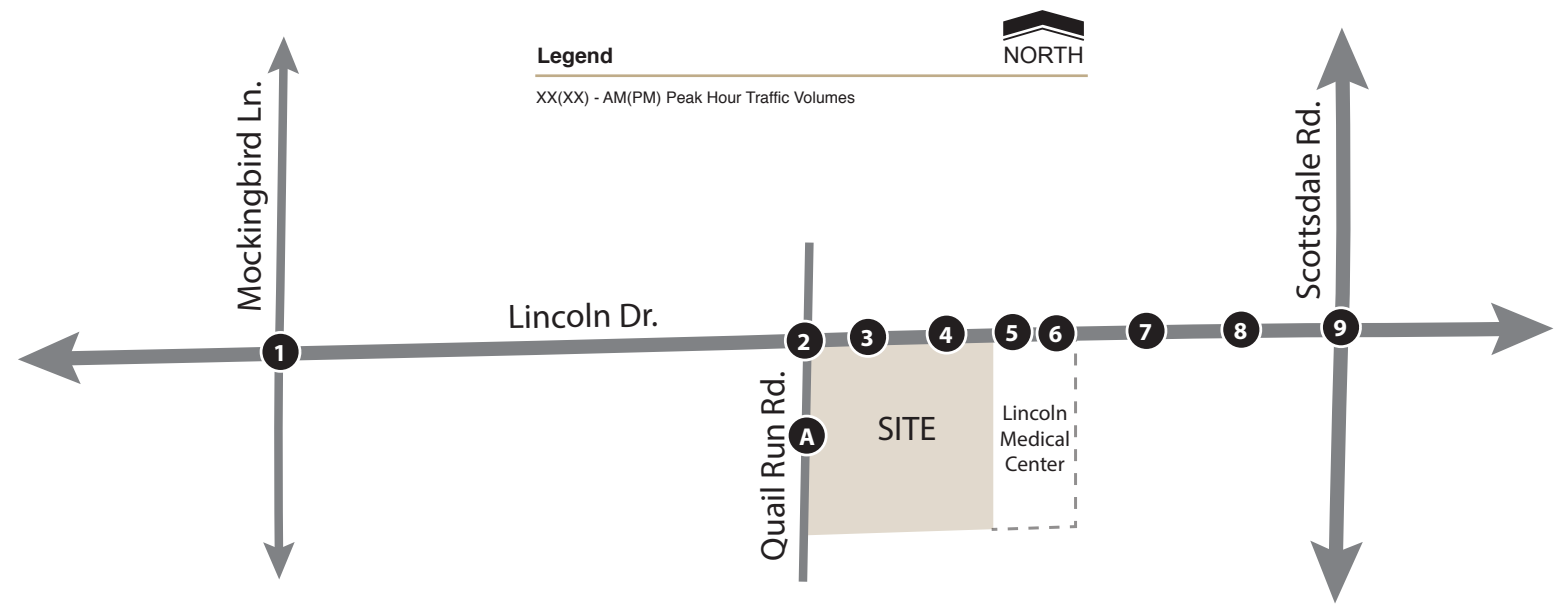
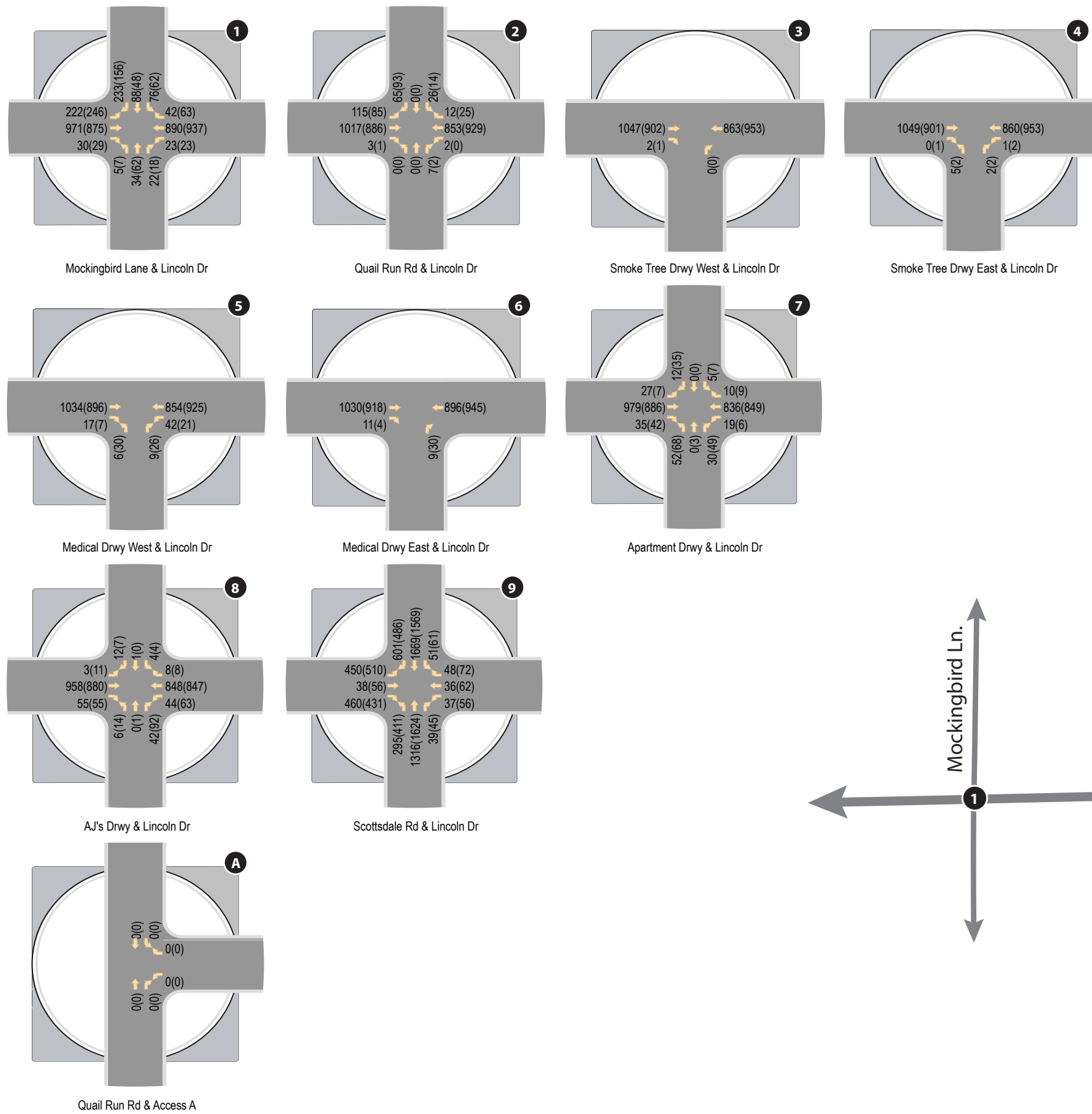

Figure 7: 2020 Background Traffic Volumes

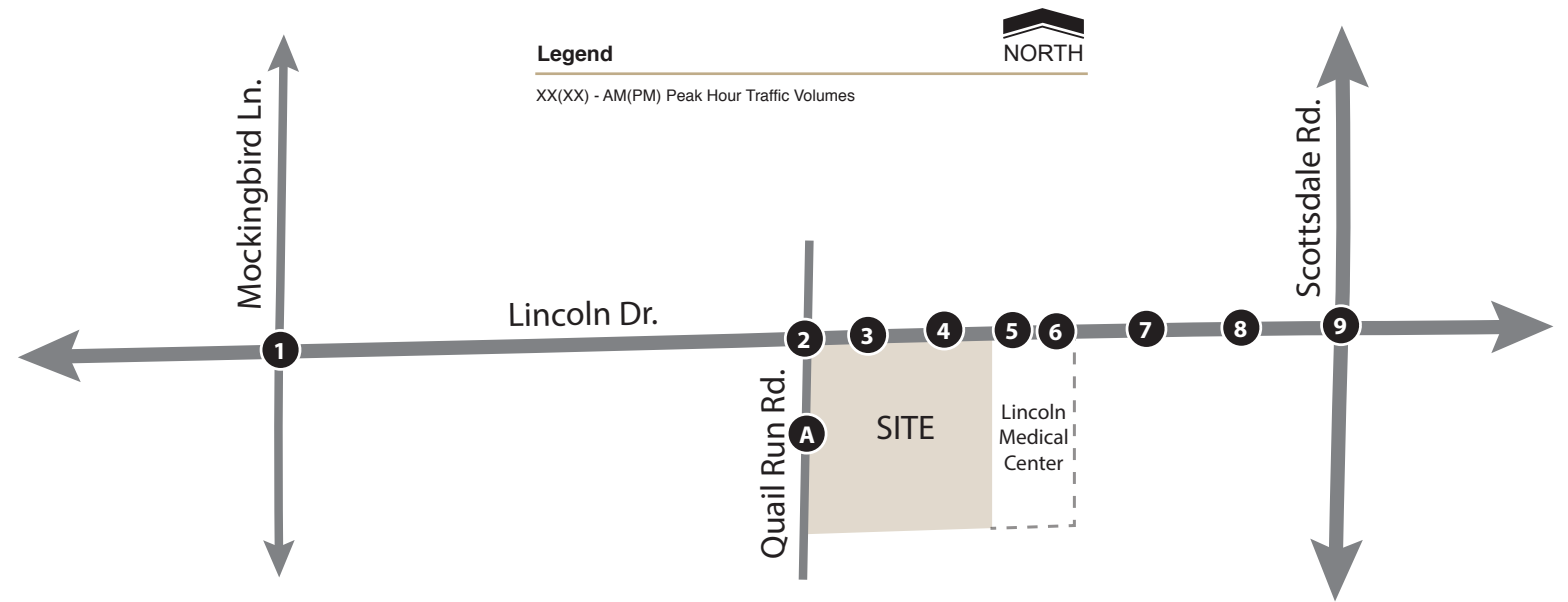
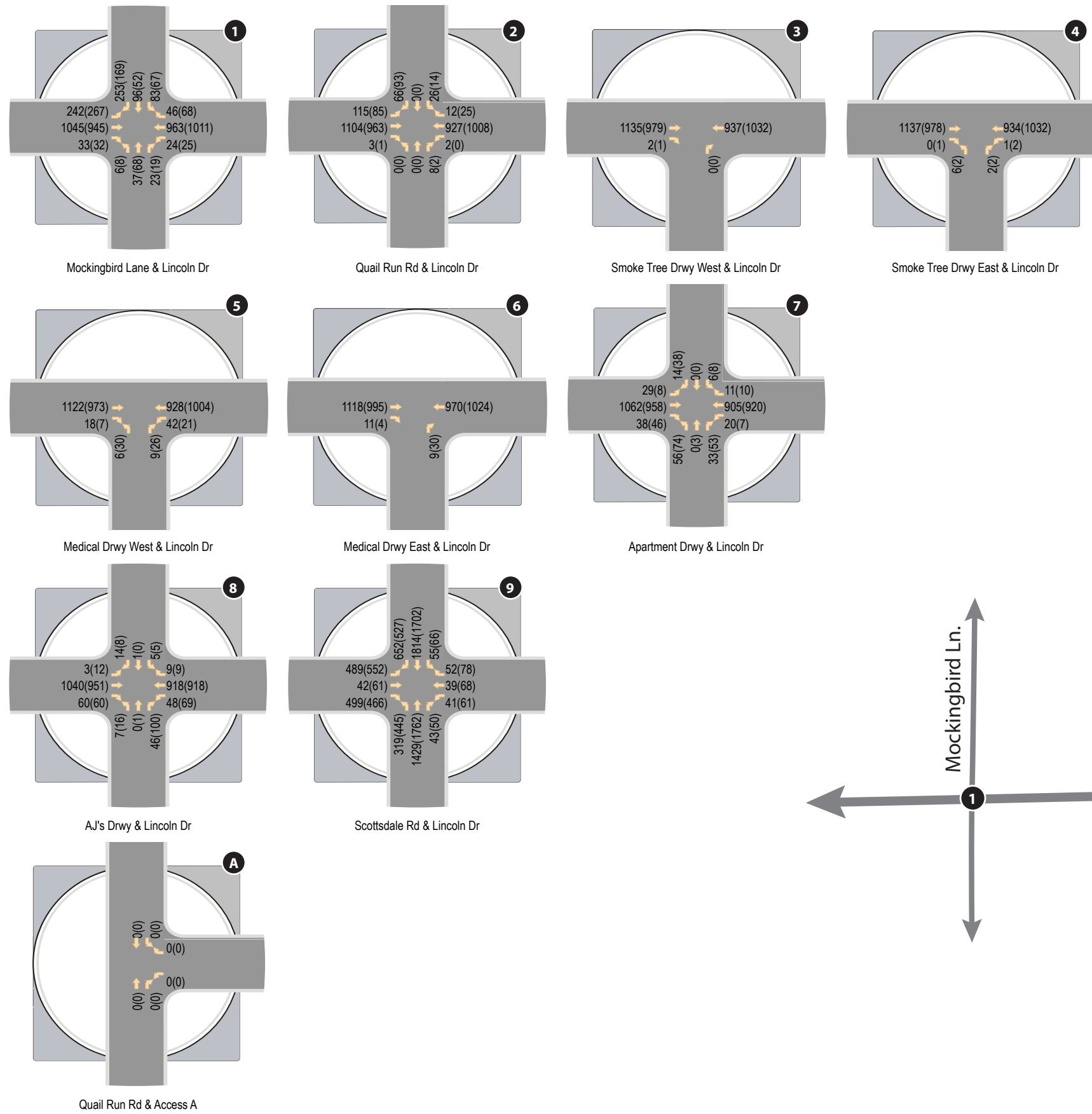

Figure 8: 2025 Background Traffic Volumes

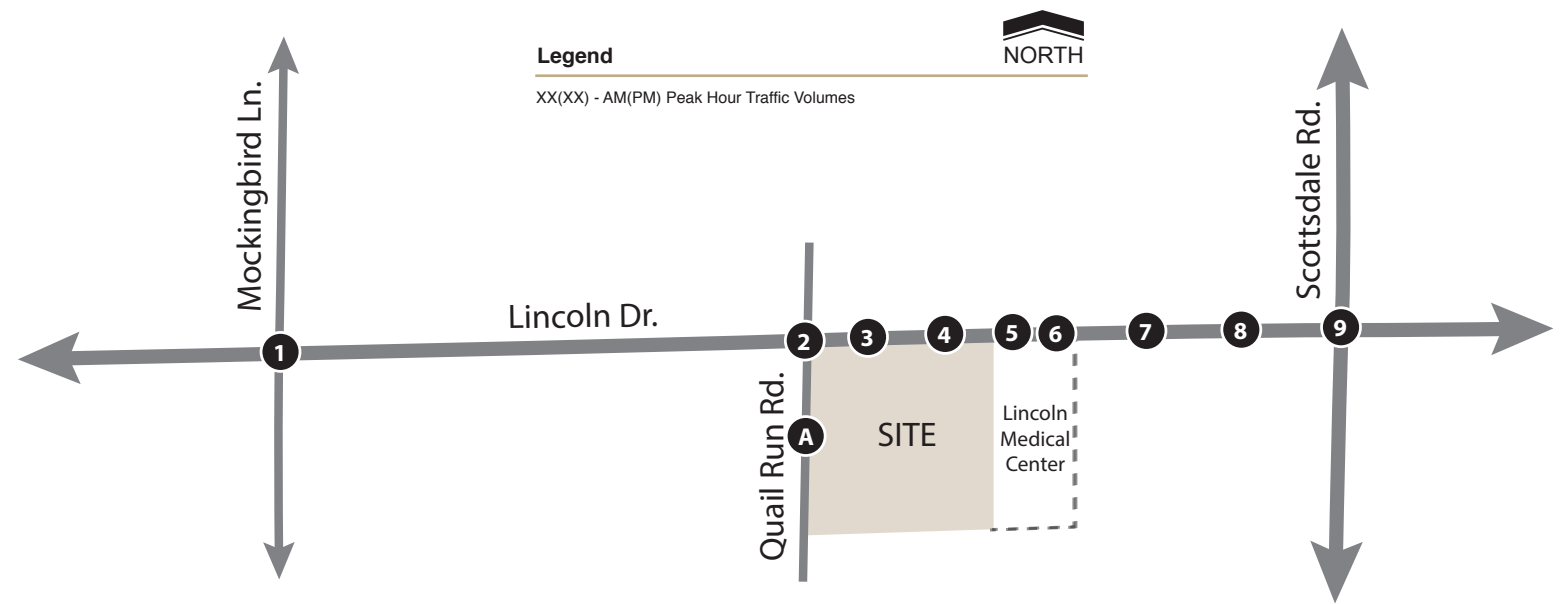
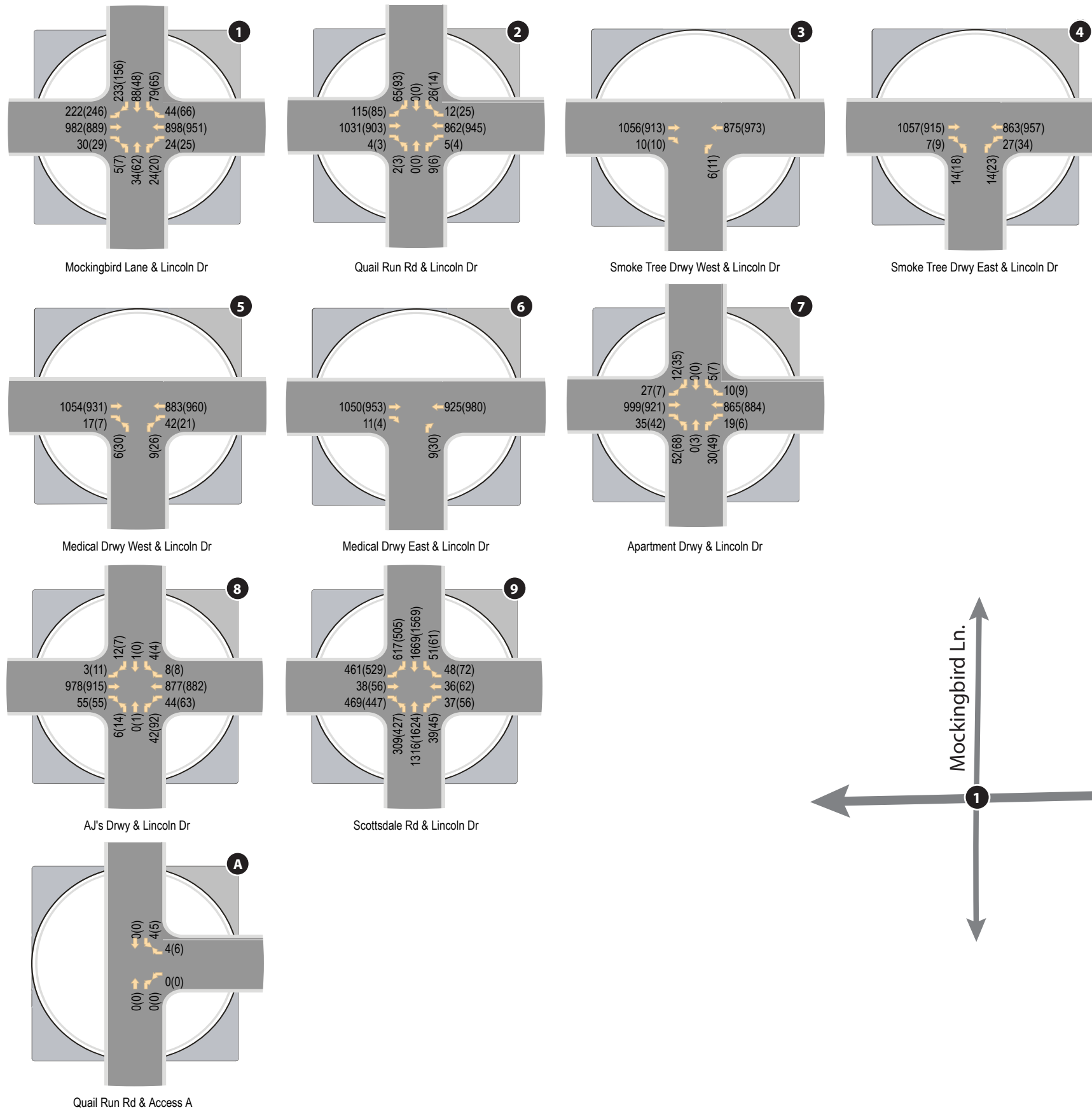

Figure 9: 2020 Total Traffic Volumes

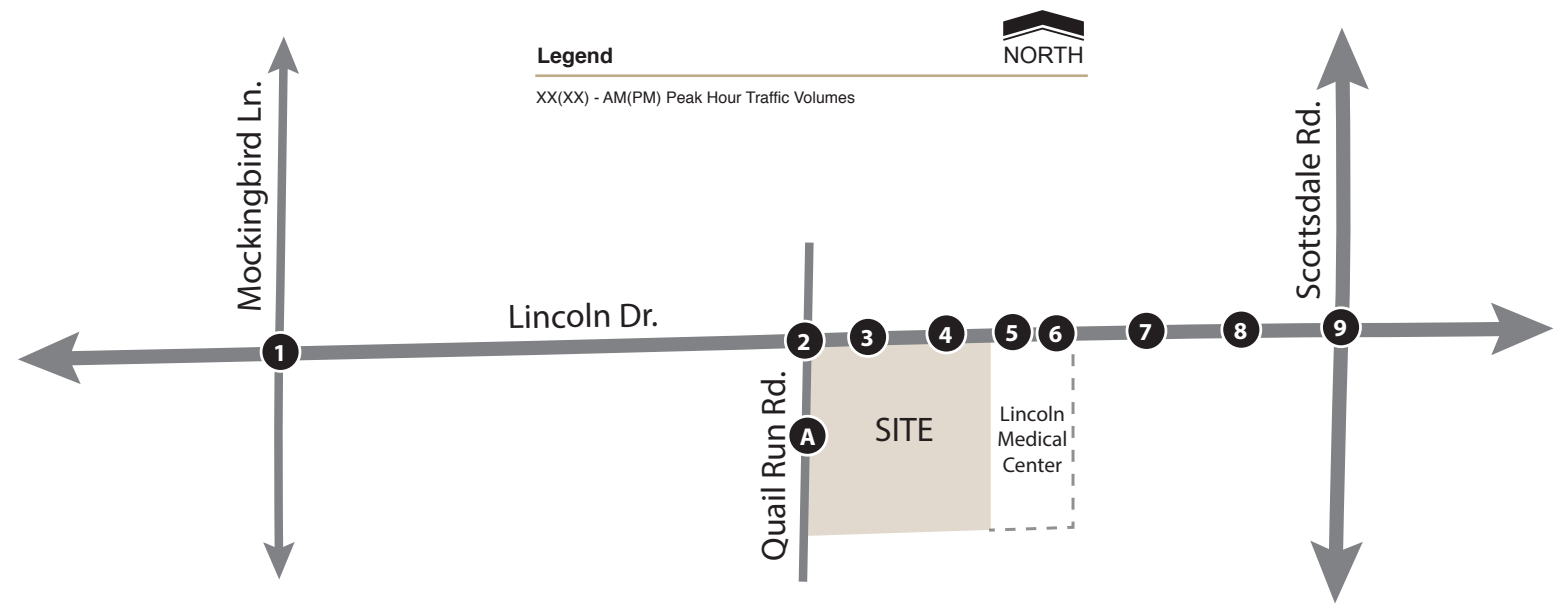
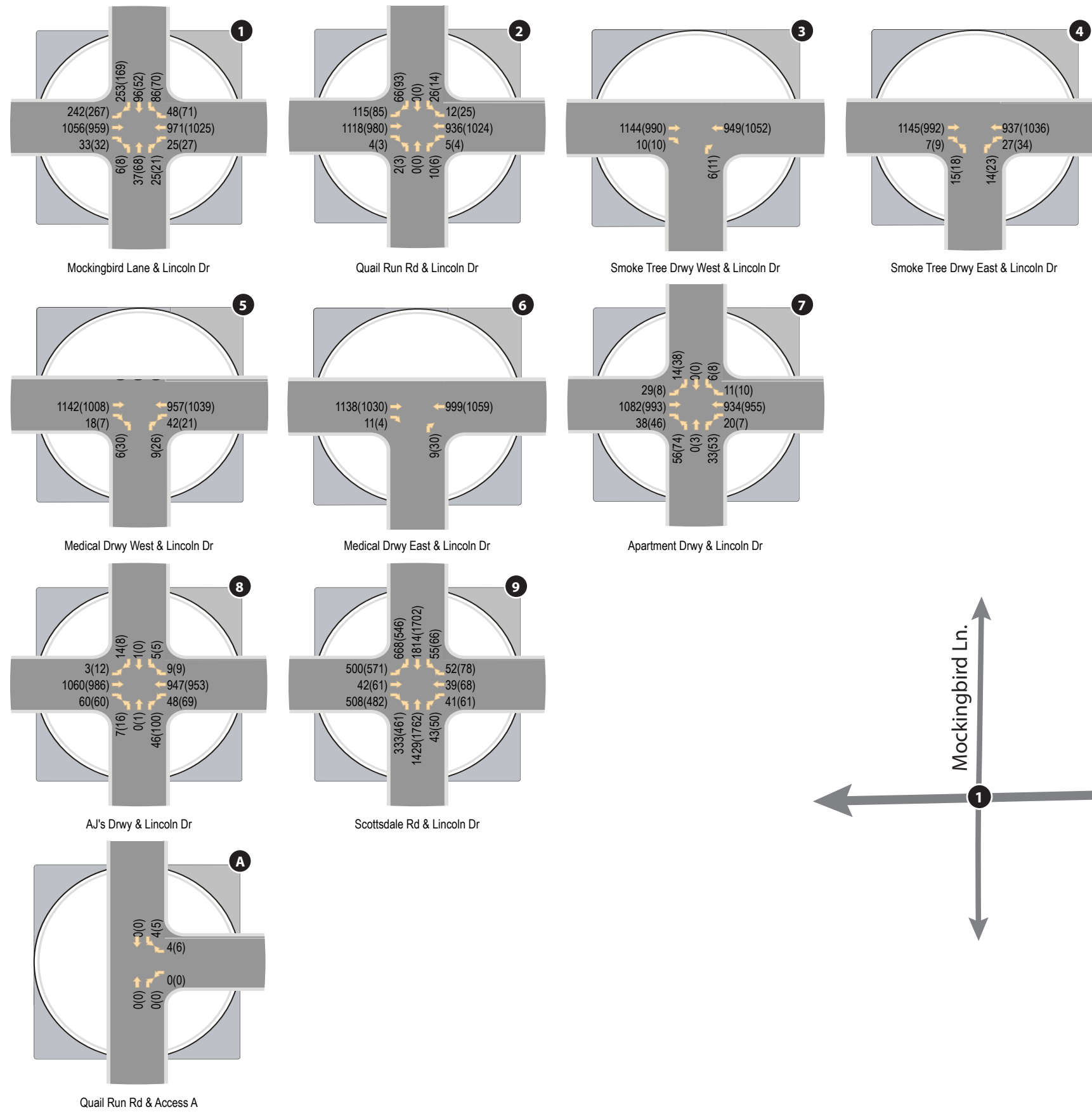

Figure 10: 2025 Total Traffic Volumes

TRAFFIC AND IMPROVEMENT ANALYSIS

INTERSECTION CAPACITY ANALYSIS

Peak hour capacity analyses have been conducted for all of the intersections within the study area. All study area intersections were analyzed using Synchro 10.0 analysis software and the methodologies previously presented. Signalized intersections were analyzed with signal timing presented by the Town of Paradise Valley and the City of Scottsdale. According to the City of Scottsdale, the intersection of **Scottsdale Road & Lincoln Drive** will be restriped in the future to operate with dual left turn lanes and a shared through/right turn lane. It is unknown by what year these improvements will be made, so all analysis will be conducted using the existing lane configurations. The overall intersection and approach levels of service are summarized in **Table 6** for the 2020 opening year and 2025 horizon. Detailed analysis worksheets can be found in **Appendix G** and **Appendix H**.

Table 6: Peak Hour Levels of Service

ID	Intersection	Intersection Control	Approach/ Movement	2020 LOS AM(PM)		2025 LOS AM(PM)	
				No-Build	Build	No-Build	Build
1	Mockingbird Ln & Lincoln Dr	Signal	NB	D(E)	D(E)	D(E)	D(E)
			SB	E(E)	E(E)	E(E)	E(E)
			EB	B(A)	B(A)	B(A)	B(A)
			WB	B(A)	B(A)	C(B)	C(B)
			Overall	C(B)	C(B)	C(B)	C(B)
2	Quail Run Rd & Lincoln Dr	Signal	NB	B(B)	B(B)	B(B)	B(B)
			SB	B(B)	B(B)	B(C)	B(C)
			EB	B(A)	B(A)	A(A)	A(A)
			WB	D(D)	D(D)	D(D)	D(D)
			Overall	C(C)	C(C)	C(C)	C(C)
3	Smoke Tree Drwy West & Lincoln Dr	1-way stop (NB)	NB	A(A)	B(B)	A(A)	B(B)
			Shared/Right WB Left	A(A)	-(-)	A(A)	-(-)
4	Smoke Tree Drwy East & Lincoln Dr	1-way stop (NB)	NB Shared WB Left	C(C) B(B)	C(C) B(B)	C(C) B(B)	C(C) B(B)
5	Medical Drwy West & Lincoln Dr	1-way stop (NB)	NB Shared WB Left	C(C) B(B)	C(C) B(B)	C(C) B(B)	C(C) B(B)
6	Medical Drwy East & Lincoln Dr	1-way stop (NB)	NB	B(B)	B(B)	B(B)	B(B)
			Shared/Right WB Left	B(A)	-(-)	B(A)	-(-)
7	Apartment Drwy & Lincoln Dr	2-way Stop (NB/SB)	NB Shared	F(F)	F(F)	F(F)	F(F)
			SB Left	F(F)	F(F)	F(F)	F(F)
			SB Right	B(B)	B(B)	B(B)	B(B)
			EB Left	B(B)	B(B)	B(B)	B(B)
			WB Left	B(B)	B(B)	B(B)	B(B)
8	AJ's Drwy & Lincoln Dr	2-way Stop (NB/SB)	NB Shared	C(D)	C(E)	D(F)	D(F)
			SB Left	F(F)	F(F)	F(F)	F(F)
			SB Right	B(B)	B(B)	B(B)	B(B)
			EB Left	B(B)	B(B)	B(B)	B(B)
			WB Left	B(B)	B(B)	B(B)	B(B)
9	Scottsdale Rd & Lincoln Dr	Signal	NB	C(C)	C(C)	C(D)	C(D)
			SB	D(D)	D(D)	D(D)	D(D)
			EB	F(E)	F(E)	F(F)	F(F)
			WB	E(F)	E(F)	E(F)	E(F)
			Overall	D(D)	D(D)	D(D)	E(D)
A	Quail Run Rd & Access A	1-way stop (WB)	SB Left	-(-)	A(A)	-(-)	A(A)
			WB Right	-(-)	A(A)	-(-)	A(A)

The results of the Synchro analysis summarized in **Table 6** indicates that all study intersections are anticipated to experience an acceptable level of service, with the exception of the intersections of **Apartment Driveway & Lincoln Drive**, **AJ's Driveway & Lincoln Drive**, and **Scottsdale Road & Lincoln Drive**.

The intersections of **Apartment Driveway & Lincoln Drive** and **AJ's Driveway & Lincoln Drive** experience delays in the northbound left turn approach and southbound left turn. Both of these approaches and driveways are driveways for AJ's Fine Foods and the existing Lincoln Apartments. The addition of Smoke Tree Resort is not the cause of these delays, which remains consistent with the existing condition. It is possible that a raised median will be installed along the length of Lincoln Drive. If this is true, then these movements would be restricted and no longer cause delay.

The intersection of **Scottsdale Road & Lincoln Drive** is expected to experience delay on the eastbound and westbound approaches during both the AM and PM peak hours for both the 2020 and 2025 horizon years. The intersection operates at an acceptable level of service overall, except during the AM peak hour of the 2025 full build scenario, however, this delay is only 55.4 seconds which is just over the threshold of an acceptable level of service. Since the City of Scottsdale is planning on reconfiguring the intersection in the future, no mitigation measures for this intersection will be taken or are recommended at this time.

The intersection of **Quail Run Road and Access A** reports a delay of zero seconds using the HCM 6th edition methodology. No LOS is reported in the included appendices, however zero seconds of delay would yield an LOS of A, shown in the table.

The proposed lane configurations are presented in **Figure 11**.

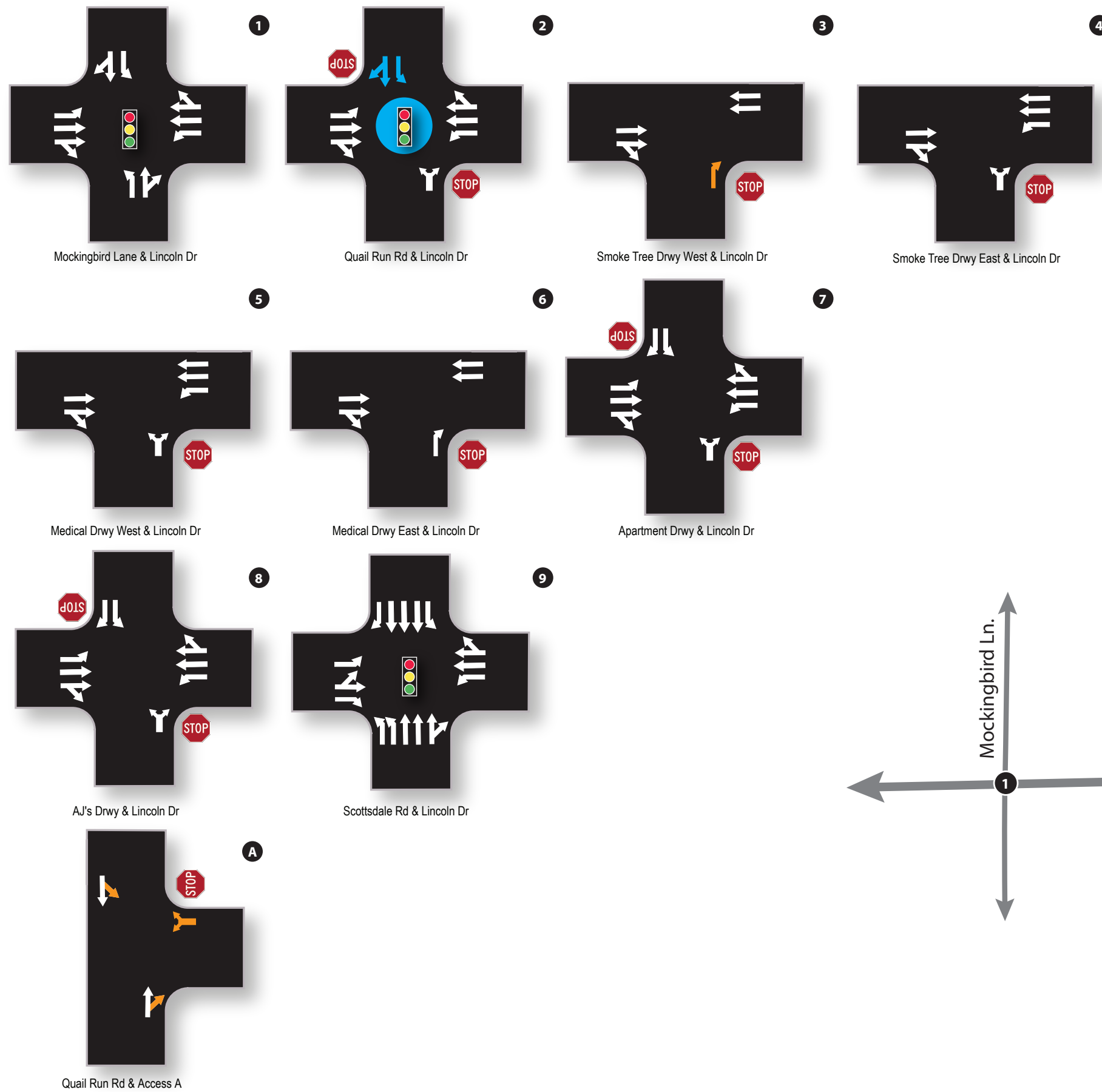

Thru or Turning Movement	NORTH
Traffic Signal	Stop Sign
Improvements by Ritz Carlton	
Improvements by Developer	

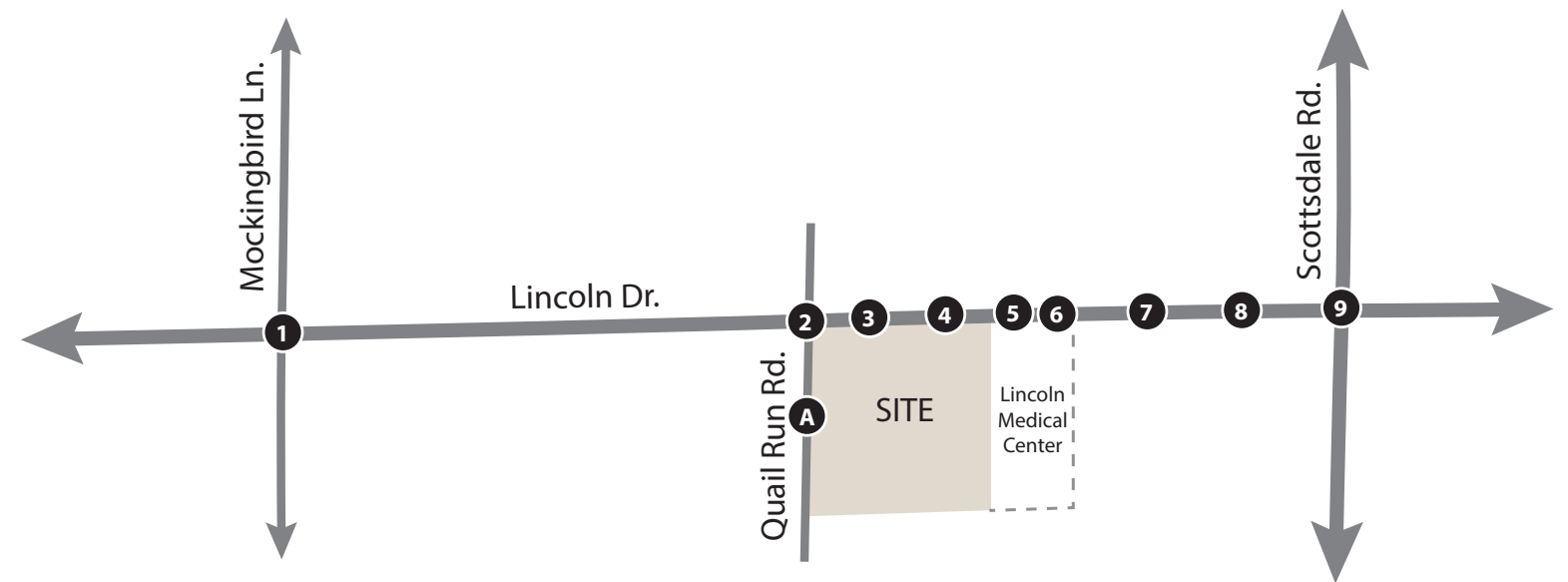

Figure 11: Proposed Lane Configurations and Traffic Controls

QUEUE LENGTH ANALYSIS

Adequate turn storage should be supplied on any approach where turn lanes are permitted and/or warranted. A queuing analysis was performed for all warranted/recommended and existing intersection turn lanes where site traffic is expected as well as left turn lanes adjacent to the site. According to the methodology documented in *A Policy on Geometric Design of Highways and Streets* (the AASHTO “Green Book”), the storage length for a turn lane is typically estimated as the length required to hold the average number of arriving vehicles per two minutes, where unsignalized, or per one-and-a half signal cycles, where signalized.¹ The formulas used for the calculations are shown below.

For signalized intersections, the storage length is determined by the following formula:

$$\text{Storage Length} = [1.5 \times (\text{veh/hr})/(\text{cycles/hr})] \times 25 \text{ feet}$$

For unsignalized intersections, the storage length is determined by the following formula:

$$\text{Storage Length} = [(\text{veh/hr})/(30 \text{ periods/hr})] \times 25 \text{ feet}$$

Using the traffic volumes and lane configurations projected for the 2025 horizon year, the resulting turn lane storage for turn movements affiliated with the site using AASHTO guidelines were calculated with a 120-second cycle length and are summarized in **Table 7**. Calculations for the queue storage length recommendations are provided in **Appendix I**.

Table 7: Queue Storage Lengths

ID	Intersection	Intersection Control	Movement	Queue Storage			
				Existing ⁽¹⁾	AASHTO	95 th Percentile	Recommended
1	Mockingbird Lane & Lincoln Dr	Signalized	NB Left	85'	25'	25'	85'
			SB Left	130'	150'	101'	130'
			EB Left	145'	400'	196'	⁽⁴⁾ 145'
			WB Left	100'	50'	43'	100'
2	Quail Run Rd & Lincoln Dr	Signalized	EB Left	-	200'	120'	150'
			WB Left	-	25'	12'	150'
			WB Right	-	50'	-	150'
9	Scottsdale Rd & Lincoln Dr	Signalized	NB Left	275'	675'	278'	275'
			SB Left	185'	100'	127'	185'
			EB Left	175'	825'	555'	⁽³⁾ 175'
			WB Left	90'	100'	131'	⁽⁴⁾ 90'
			SB Right	315'	1,000'	455'	⁽²⁾ 350'
			EB Right	175'	750'	515'	175'

(1) Measured from stop bar to end of storage length

(2) Max storage length recommended for signalized intersection

(3) Extending this turn will interfere with left turns into AJ's Fine Foods driveway

(4) Not the responsibility of the developer

¹ The American Association of Highway and Transportation Officials on pages 714-715 of its publication, *Geometric Design of Highways and Streets* (“AASHTO Green Book”), indicates that storage length for a turn lane, exclusive of taper, “should usually be based on one and one-half to two times the average number of vehicles that would store per cycle” at a signalized intersection.

According to the CivTech study done for the Ritz Carlton, the newly signalized intersection of Quail Run Road and Lincoln Drive will have eastbound/westbound left turn lanes and a westbound right turn lane striped with 150 feet of storage each. The recommended storage lengths in **Table 7** are provided for horizon year 2025 using the total traffic projections.

The Smoke Tree Resort is requesting a full access at its eastern most entrance anticipating that the addition of a median will restrict the western most driveway to a right in/right out.

The required westbound left turn storage requirement for this movement is 50 feet, which is the minimum requirement based on AASHTO standards. The design would require an exception to the standard 90 foot taper length in order to provide the required queue for the back to back left turns. Should all driveways for Smoke Tree Resort be restricted to right in/right out only, the proposed Access A on Quail Run Road would be highly utilized for vehicles egressing the site and travelling west or vehicles entering the site from the east.

SIGHT DISTANCE ANALYSIS

Adequate sight distance must be provided at intersections and site access driveways to allow safe turning movements. There must be sufficient unobstructed sight distance along both approaches of a street/driveway intersection and across their included corners to allow operators of vehicles to see each other in time to prevent a collision.

The Town of Paradise Valley maintains sight distance requirements within their City Code, standard details and development services guidelines. The Town of Paradise Valley measures sight distance using AASHTO methodology except that the sight triangle from the driveway is measured from the center of the egress lane, 14.5 feet back from the curb return line. Sight distance calculations according to AASHTO guidelines are summarized in **Table 8**.

Table 8: AASHTO Sight Distance Requirements

Roadway	Posted Speed Limit (mph)	Design Speed (mph)	Sight Distance Along Roadway		
			Left of Driveway (Case B2/B3)	Right of Driveway (Case B1)	On Major Road (Case F)
Smoke Tree West Access & Lincoln Rd	35	40	415'	Restricted	Restricted
Smoke Tree East Access & Lincoln Rd	35	40	765'	825'	710'
Quail Run Rd & Access A	-	30	290'	335'	245'

There are no existing obstructions to sight distance within the project intersection or along the included corners of the proposed intersection. Adequate site distance must be provided at the intersections to allow safe left and right turning movements from the development. Recommended distances for these movements can be found in the table above.

The contractor should ensure that sight visibility is provided at all proposed intersections according to the distances shown in **Table 8** and that sight triangles at public intersections are maintained according to the Town Code. All vegetation and trees should be maintained according to Town of Paradise Valley regulations. Sight distance worksheets have been included within **Appendix J**.

CONCLUSIONS

The following conclusions have been documented in this study.

Existing Conditions

- The results of the existing conditions analysis indicates that all intersections currently operate at an overall acceptable level of service (LOS D or better), with the exception of the intersections of Apartment Driveway & Lincoln Drive and AJ's Driveway & Lincoln Drive under the existing lane configurations.
 - The intersections of **Apartment Driveway & Lincoln Drive and AJ's Driveway & Lincoln Drive** experience delays in the northbound left turn approach and southbound left turn. Both of these approaches and driveways are driveways for AJ's Fine Foods and existing Apartments. It is possible that a raised median will be installed along the length of Lincoln Drive.

Opening Year 2020 and Horizon Year 2025

- The results of the Synchro analysis indicates that all study intersections are anticipated to experience an acceptable level of service, with the exception of the intersections of **Apartment Driveway & Lincoln Drive, AJ's Driveway & Lincoln Drive, and Scottsdale Road & Lincoln Drive.**
 - The intersections of **Apartment Driveway & Lincoln Drive and AJ's Driveway & Lincoln Drive** experience delays in the northbound left turn approach and southbound left turn. Both of these approaches and driveways are driveways for AJ's Fine Foods and the existing Lincoln Apartments. The addition of Lincoln Medical Center is not the cause of these delays, which remains consistent with the existing condition. It is possible that a raised median will be installed along the length of Lincoln Drive. If this is true, then these movements would be restricted and no longer cause delay.
 - The intersection of **Scottsdale Road & Lincoln Drive** is expected to experience delay on the eastbound and westbound approaches during both the AM and PM peak hours for both the 2020 and 2025 horizon years. The intersection operates at an acceptable level of service overall, except during the AM peak hour of the 2025 full build scenario, however, this delay is only 55.4 seconds which is just over the threshold of an acceptable level of service. Since the City of Scottsdale is planning on reconfiguring the intersection in the future, no mitigation measures for this intersection will be taken or are recommended at this time.
- The intersection of **Quail Run Road and Access A** reports a delay of zero seconds using the HCM 6th edition methodology. No LOS is reported in the

included appendices, however zero seconds of delay would yield an LOS of A, shown in the table.

Queue Storage and Sight Distance

- According to the CivTech study done for the Ritz Carlton, the newly signalized intersection of Quail Run Road and Lincoln Drive will have eastbound/westbound left turn lanes and a westbound right turn lane striped with 150 feet of storage each. While 150 feet is being proposed due to the current development agreement with Five Star Development for the Ritz Carlton, less is required to meet the recommended AASHTO length. The recommended storage lengths are provided for horizon year 2025 using the total traffic projections.
- There are no existing obstructions to sight distance within the project intersections or along the included corners of the proposed intersection. Adequate site distance must be provided at the intersections to allow safe left and right turning movements from the development
 - The contractor should ensure that sight visibility is provided at all proposed intersections according to the distances and that sight triangles at public intersections are maintained according to the Town Code. All vegetation and trees should be maintained according to Town of Paradise Valley regulations.
- Smoke Tree Resort is requesting a full access at its eastern most entrance anticipating that the addition of a median will restrict the western most driveway to a right in/right out.
 - The required westbound left turn storage requirement for this movement is 50 feet, which is the minimum requirement based on AASHTO standards.
 - The design would require an exception to the standard 90 foot taper length in order to provide the required queue for the back to back left turns.
- Should all driveways for Smoke Tree Resort be restricted to right in/right out only, the proposed Access A on Quail Run Road would be highly utilized for vehicles egressing the site and travelling west or vehicles entering the site from the east.

LIST OF REFERENCES

Highway Capacity Manual. Transportation Research Board, Washington, D.C., 2000.

Manual on Uniform Traffic Control Devices. U.S. Department of Transportation, Federal Highways Administration, Washington, D.C., 2009.

Roadway Design Manual, Maricopa County Department of Transportation, Phoenix, Arizona, Revised April 2004.

Trip Generation Manual, 10th Edition, Institute of Transportation Engineers, Washington, D.C., 2016.

Trip Generation Handbook, 3rd Edition, Institute of Transportation Engineers, Washington, D.C., 2016.

Ritz Carlton Master Plan, Paradise Valley Traffic Impact Analysis (TIA), CivTech, Scottsdale, AZ, March 2016.

Lincoln Medical Center, Paradise Valley Traffic Impact Analysis (TIA), CivTech, Scottsdale, AZ, November 2018.

TECHNICAL APPENDIX

APPENDIX A:	REVIEW COMMENTS AND RESPONSES
APPENDIX B:	EXISTING TRAFFIC COUNTS
APPENDIX C:	EXISTING PEAK HOUR ANALYSIS
APPENDIX D:	TRIP GENERATION
APPENDIX E:	TRIP DISTRIBUTION
APPENDIX F:	BACKGROUND TRAFFIC
APPENDIX G:	2020 PEAK HOUR ANALYSIS
APPENDIX H:	2025 PEAK HOUR ANALYSIS
APPENDIX I:	QUEUE STORAGE ANALYSIS
APPENDIX J:	SIGHT DISTANCE ANALYSIS

APPENDIX A

REVIEW COMMENTS AND RESPONSES

APPENDIX B

EXISTING TRAFFIC COUNTS

Project #: 18-1263-001

TMC SUMMARY OF Mockingbird Ln. & Lincoln Dr.

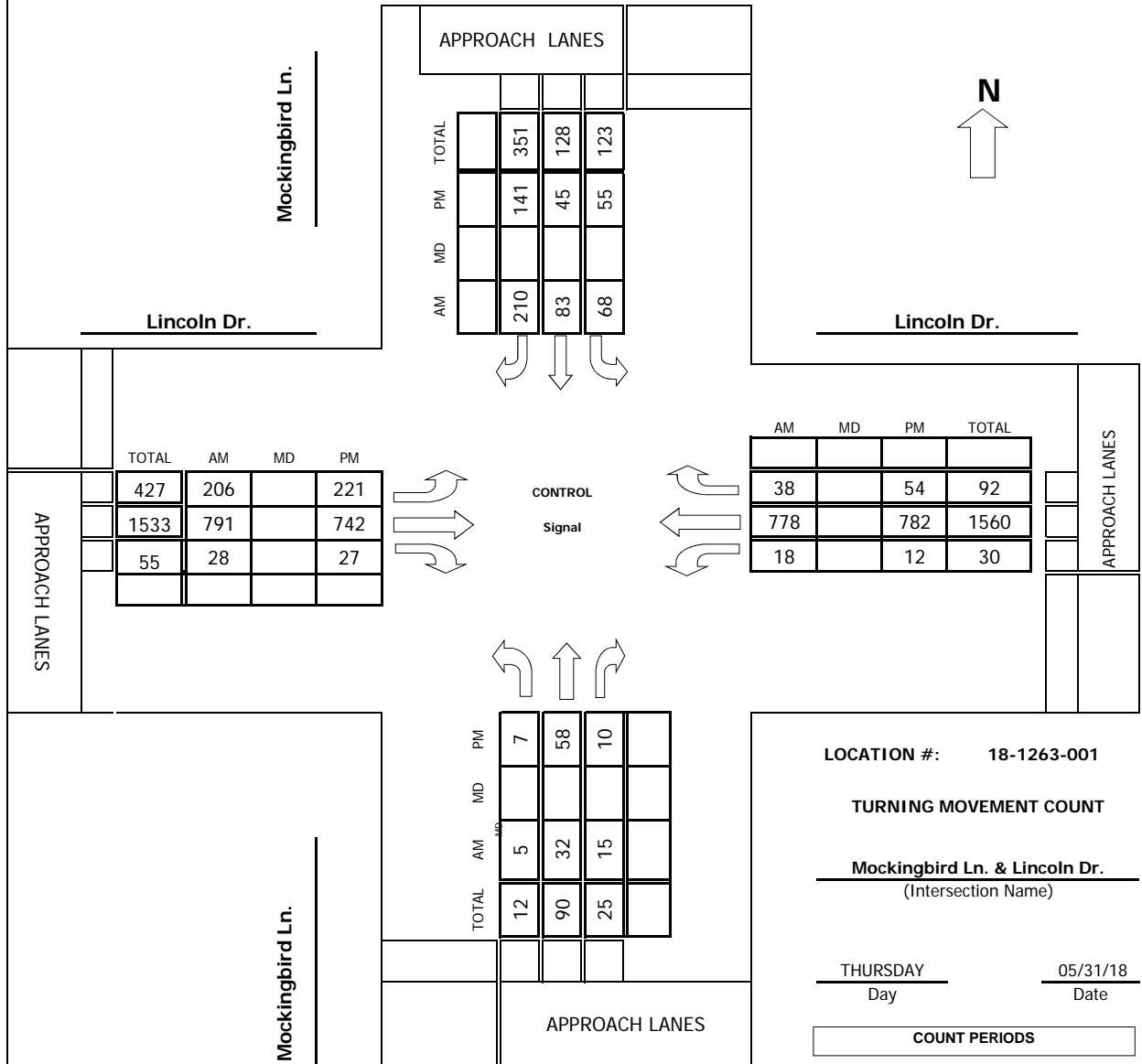

TOTAL	AM	MD	PM
427	206		221
1533	791		742
55	28		27

AM	MD	PM	TOTAL
38		54	92
778		782	1560
18		12	30

TOTAL	AM	MD	PM
12	5		7
90	32		58
25	15		10

LOCATION #: 18-1263-001

TURNING MOVEMENT COUNT

Mockingbird Ln. & Lincoln Dr.
 (Intersection Name)

THURSDAY 05/31/18
 Day Date

COUNT PERIODS	
AM	700AM - 900AM
NOON	-
PM	400PM - 600PM

AM PEAK HOUR 745 AM

NOON PEAK HOUR _____

PM PEAK HOUR 430 PM

Project #: 18-1263-002

TMC SUMMARY OF Quail Run Rd. & Lincoln Dr.

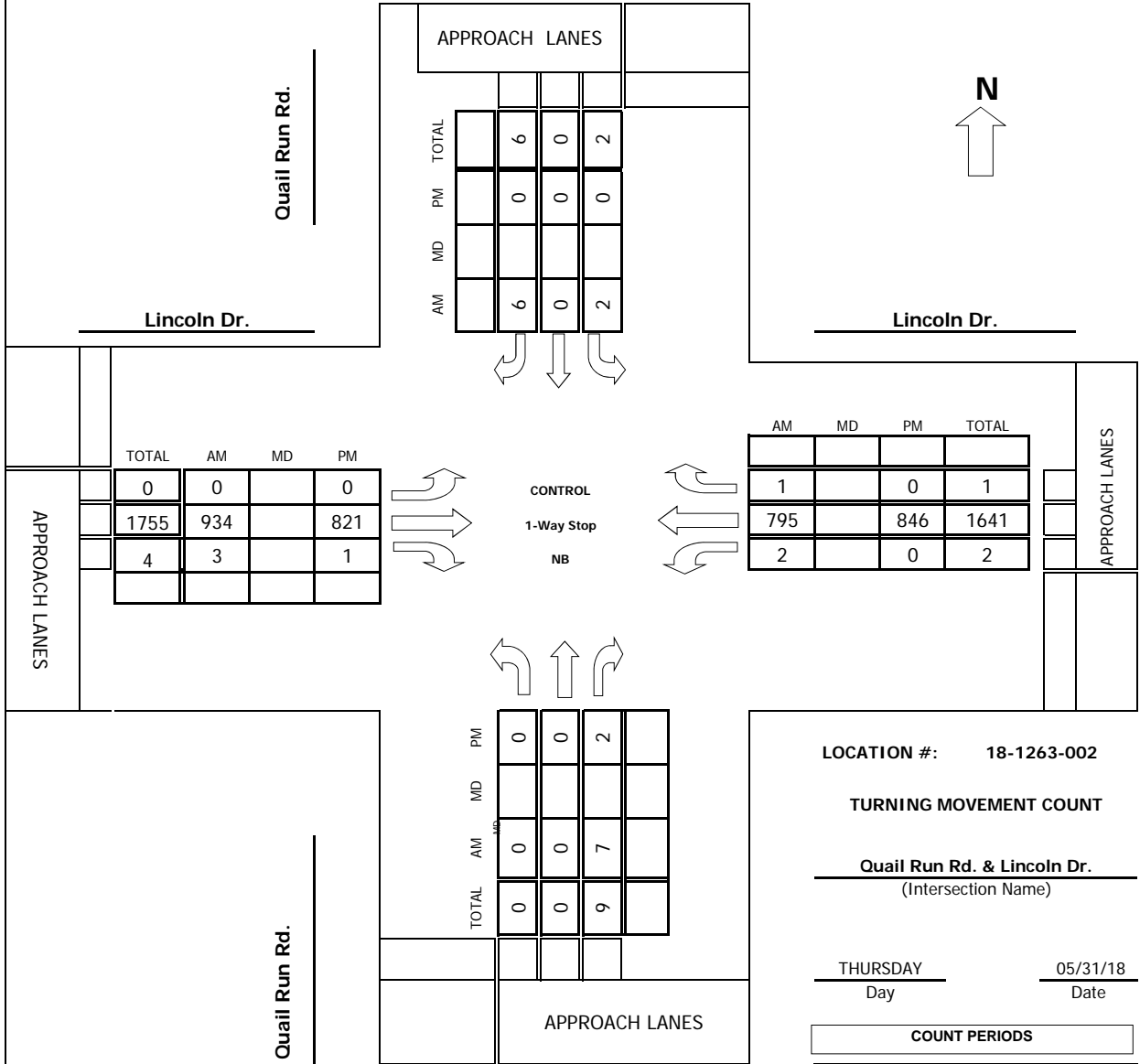

TOTAL	AM	MD	PM
0	0		0
1755	934		821
4	3		1

AM	MD	PM	TOTAL
1		0	1
795		846	1641
2		0	2

TOTAL	AM	MD	PM
0	0		0
0	0		0
9	7		2

LOCATION #: 18-1263-002

TURNING MOVEMENT COUNT

Quail Run Rd. & Lincoln Dr.
 (Intersection Name)

THURSDAY **05/31/18**
 Day Date

COUNT PERIODS	
AM	700AM - 900AM
NOON	-
PM	400PM - 600PM

AM PEAK HOUR 800 AM

NOON PEAK HOUR _____

PM PEAK HOUR 445 PM

Project #: 18-1263-003

TMC SUMMARY OF Smoke Tree West Dwy & Lincoln Dr.

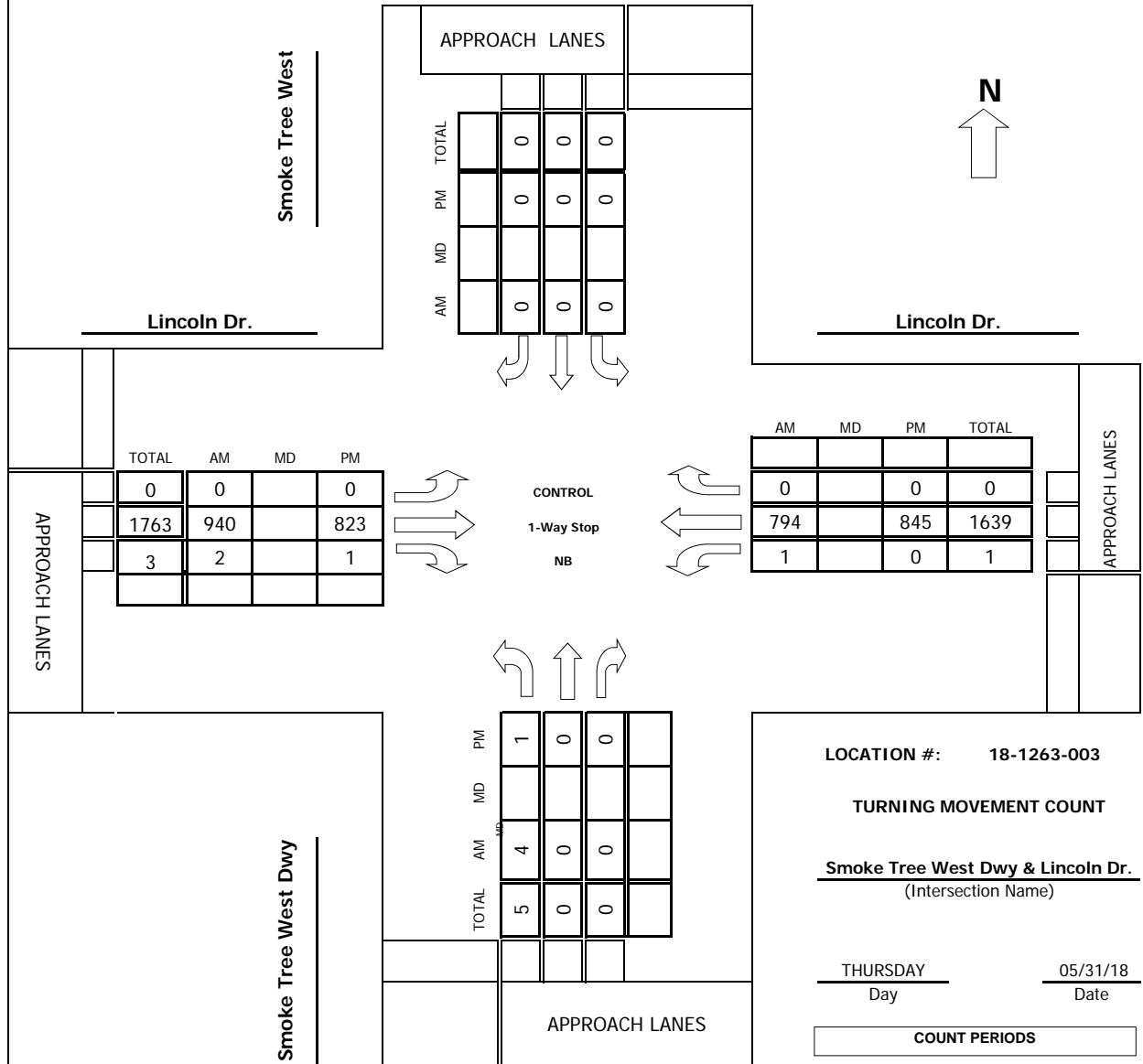

TOTAL	AM	MD	PM
0	0		0
1763	940		823
3	2		1

AM	MD	PM	TOTAL
0		0	0
794		845	1639
1		0	1

TOTAL	AM	MD	PM
5	4		1
0	0		0
0	0		0

LOCATION #: 18-1263-003

TURNING MOVEMENT COUNT

Smoke Tree West Dwy & Lincoln Dr.
 (Intersection Name)

THURSDAY 05/31/18
 Day Date

COUNT PERIODS		
AM	700AM	900AM
NOON	-	-
PM	400PM	600PM

AM PEAK HOUR 800 AM
 NOON PEAK HOUR _____
 PM PEAK HOUR 445 PM

Project #: 18-1263-004

TMC SUMMARY OF Smoke Tree East Dwy & Lincoln Dr.

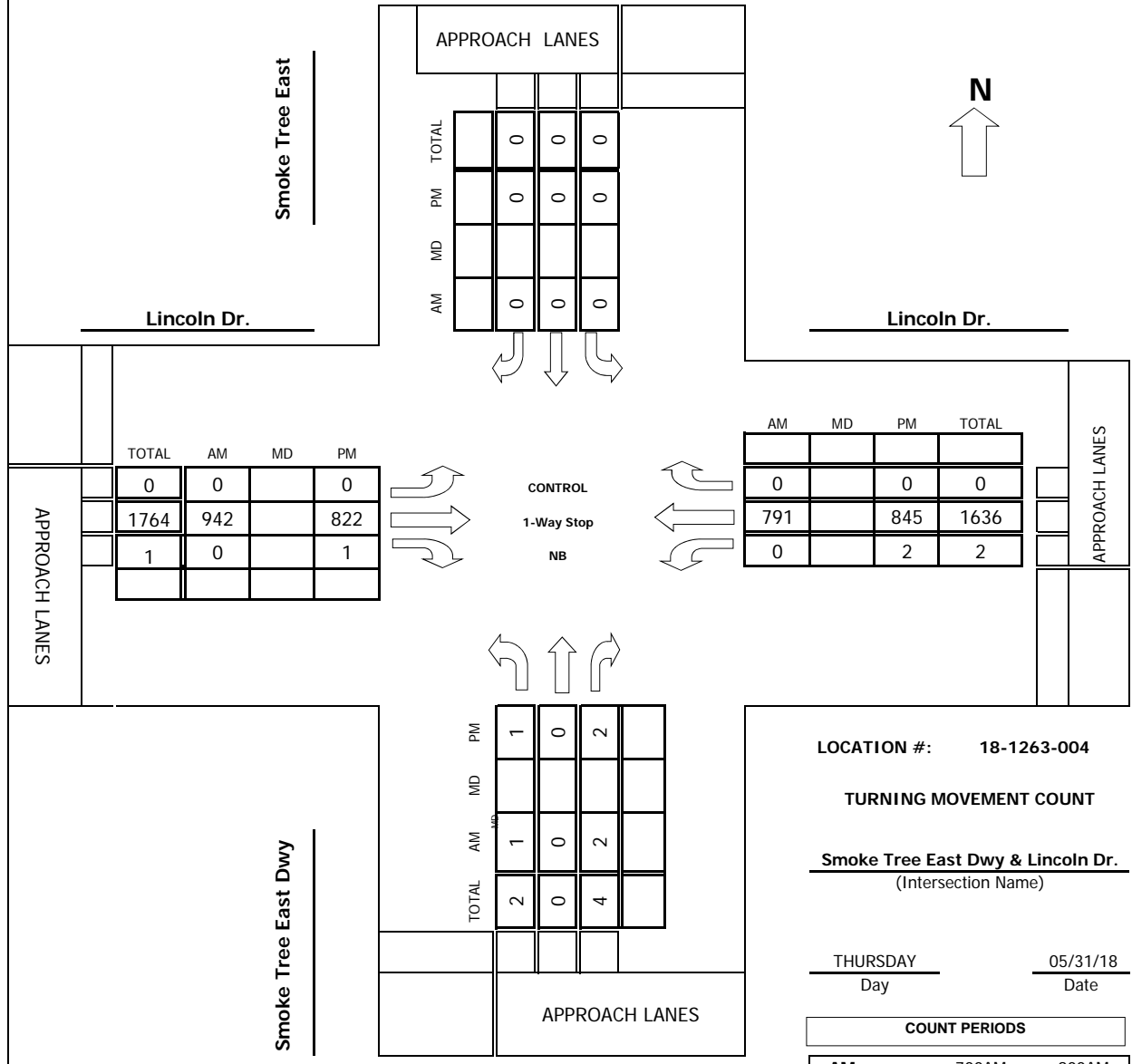

TOTAL	AM	MD	PM
0	0		0
1764	942		822
1	0		1

AM	MD	PM	TOTAL
0		0	0
791		845	1636
0		2	2

TOTAL	AM	MD	PM
2	1	0	2
0	0	0	0
4	2	2	

LOCATION #: 18-1263-004

TURNING MOVEMENT COUNT

Smoke Tree East Dwy & Lincoln Dr.
(Intersection Name)

THURSDAY **05/31/18**
Day Date

COUNT PERIODS		
AM	700AM	- 900AM
NOON	-	-
PM	400PM	- 600PM

AM PEAK HOUR 800 AM

NOON PEAK HOUR _____

PM PEAK HOUR 445 PM

Project #: 18-1263-005

TMC SUMMARY OF Medical Office West Dwy & Lincoln Dr.

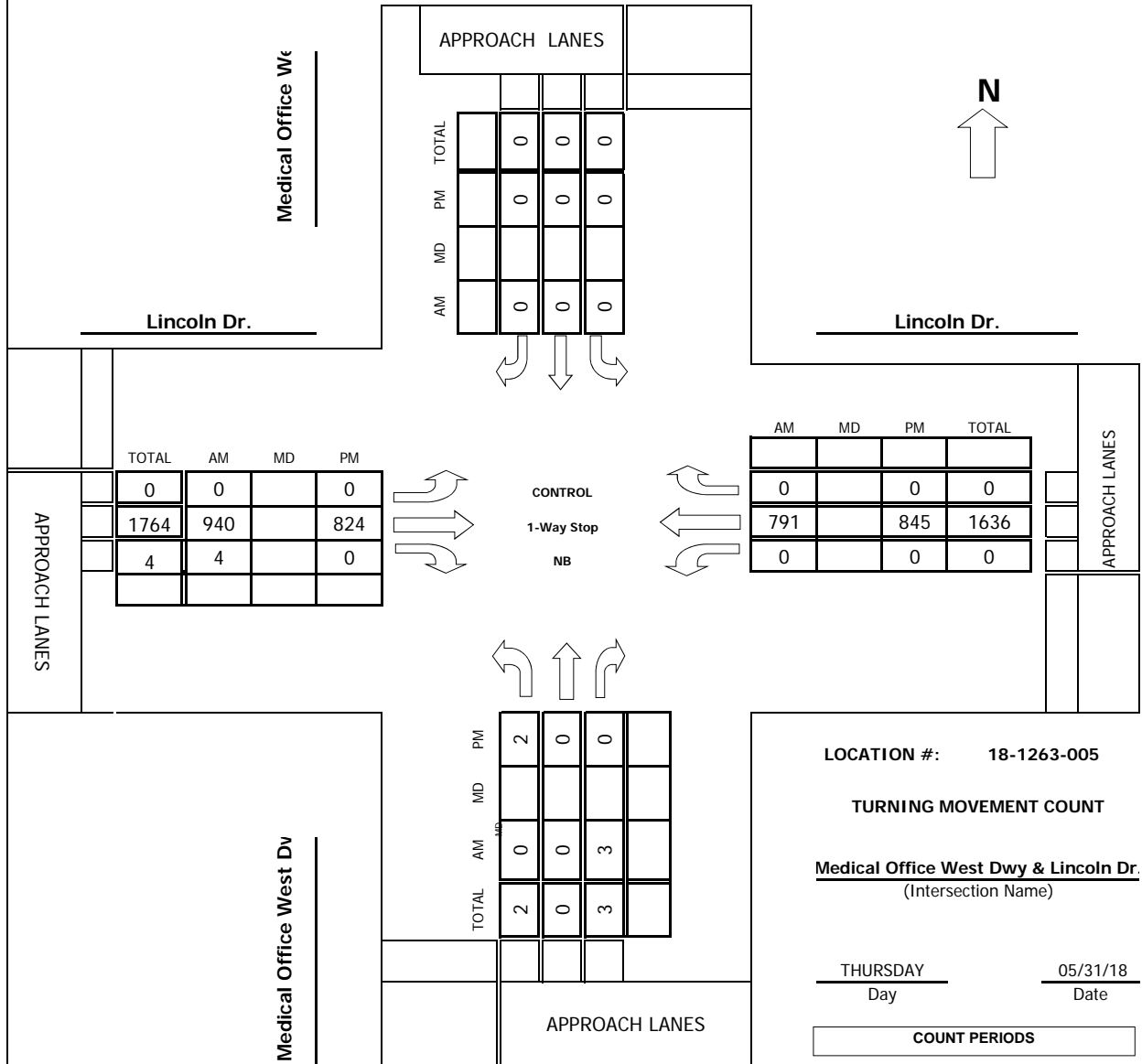

TOTAL	AM	MD	PM
0	0		0
1764	940		824
4	4		0

AM	MD	PM	TOTAL
0		0	0
791		845	1636
0		0	0

TOTAL	AM	MD	PM
2	0		2
0	0		0
3	3		0

LOCATION #: 18-1263-005

TURNING MOVEMENT COUNT

Medical Office West Dwy & Lincoln Dr.
 (Intersection Name)

THURSDAY 05/31/18
 Day Date

COUNT PERIODS	
AM	700AM - 900AM
NOON	-
PM	400PM - 600PM

AM PEAK HOUR 800 AM
 NOON PEAK HOUR _____
 PM PEAK HOUR 445 PM

Intersection Turning Movement

Prepared by:

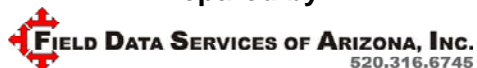

Project #: 18-1263-006

TMC SUMMARY OF Medical Office East Dwy & Lincoln Dr.

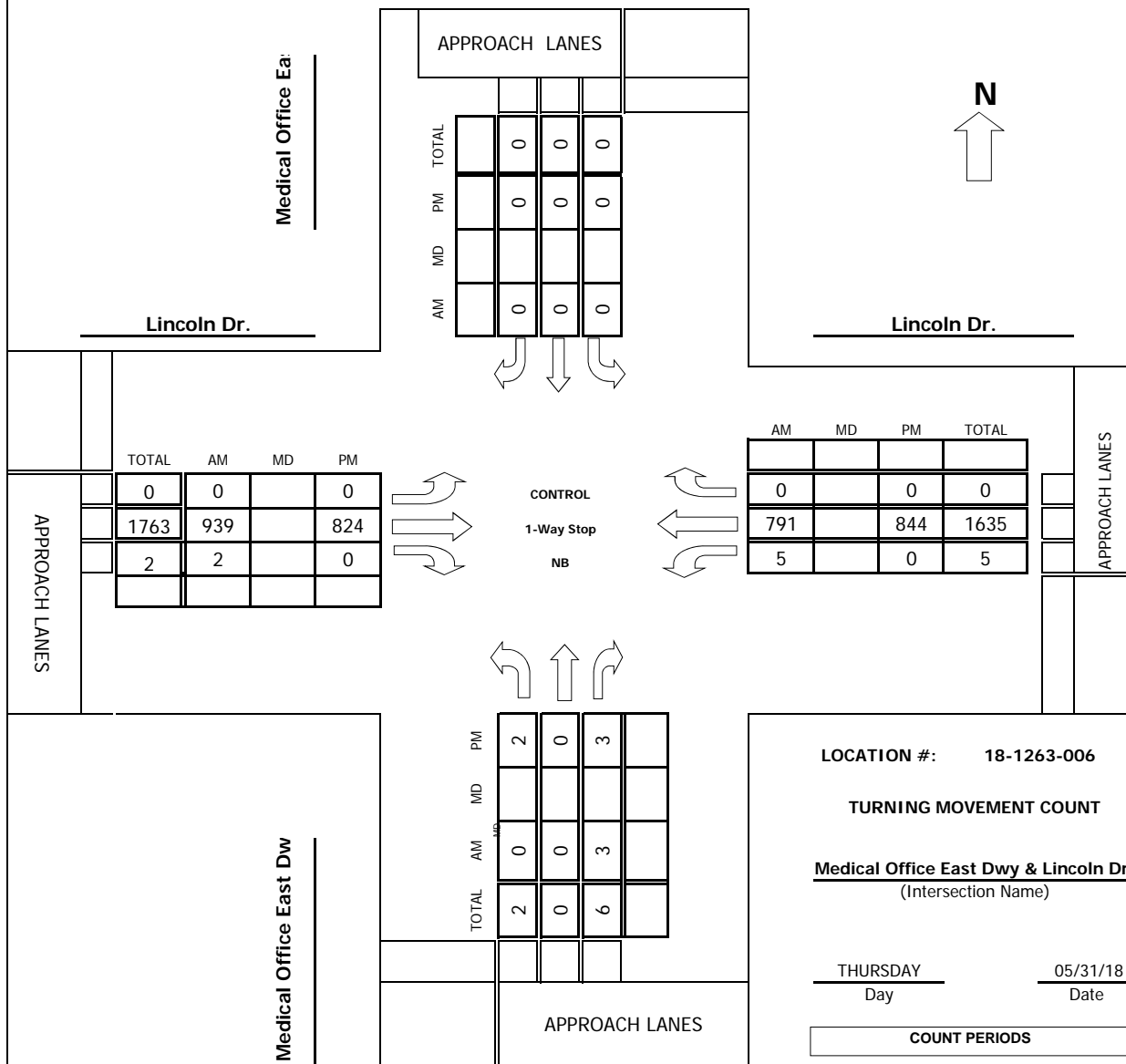

	TOTAL	AM	MD	PM
APPROACH LANES	0	0		0
	1763	939		824
	2	2		0

	AM	MD	PM	TOTAL
APPROACH LANES	0		0	0
	791		844	1635
	5		0	5

	TOTAL	AM	MD	PM
APPROACH LANES	2	0		2
	0	0		0
	6	3		3

LOCATION #: 18-1263-006

TURNING MOVEMENT COUNT

Medical Office East Dwy & Lincoln Dr.
(Intersection Name)

THURSDAY 05/31/18
Day Date

COUNT PERIODS	
AM	700AM - 900AM
NOON	-
PM	400PM - 600PM

AM PEAK HOUR 800 AM
NOON PEAK HOUR _____
PM PEAK HOUR 445 PM

Project #: 18-1263-007

TMC SUMMARY OF Apartment Driveway & Lincoln Dr.

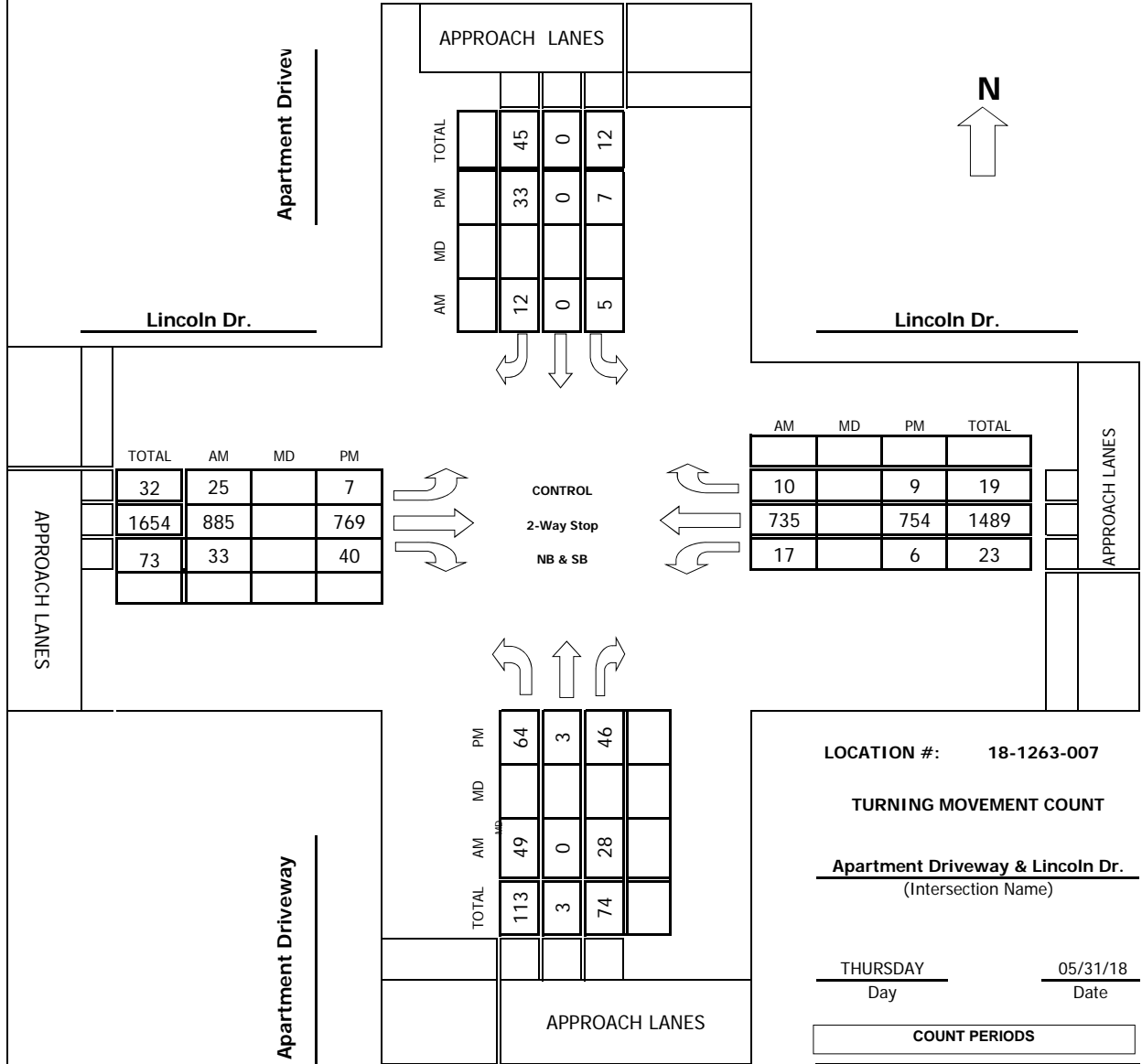

TOTAL	AM	MD	PM
32	25		7
1654	885		769
73	33		40

AM	MD	PM	TOTAL
10		9	19
735		754	1489
17		6	23

TOTAL	AM	MD	PM
113	49		64
3	0		3
74	28		46

LOCATION #: 18-1263-007

TURNING MOVEMENT COUNT

Apartment Driveway & Lincoln Dr.
 (Intersection Name)

THURSDAY 05/31/18
 Day Date

COUNT PERIODS		
AM	700AM	900AM
NOON	-	-
PM	400PM	600PM

AM PEAK HOUR 800 AM

NOON PEAK HOUR _____

PM PEAK HOUR 430 PM

Project #: 18-1263-008

TMC SUMMARY OF AJ's Driveway & Lincoln Dr.

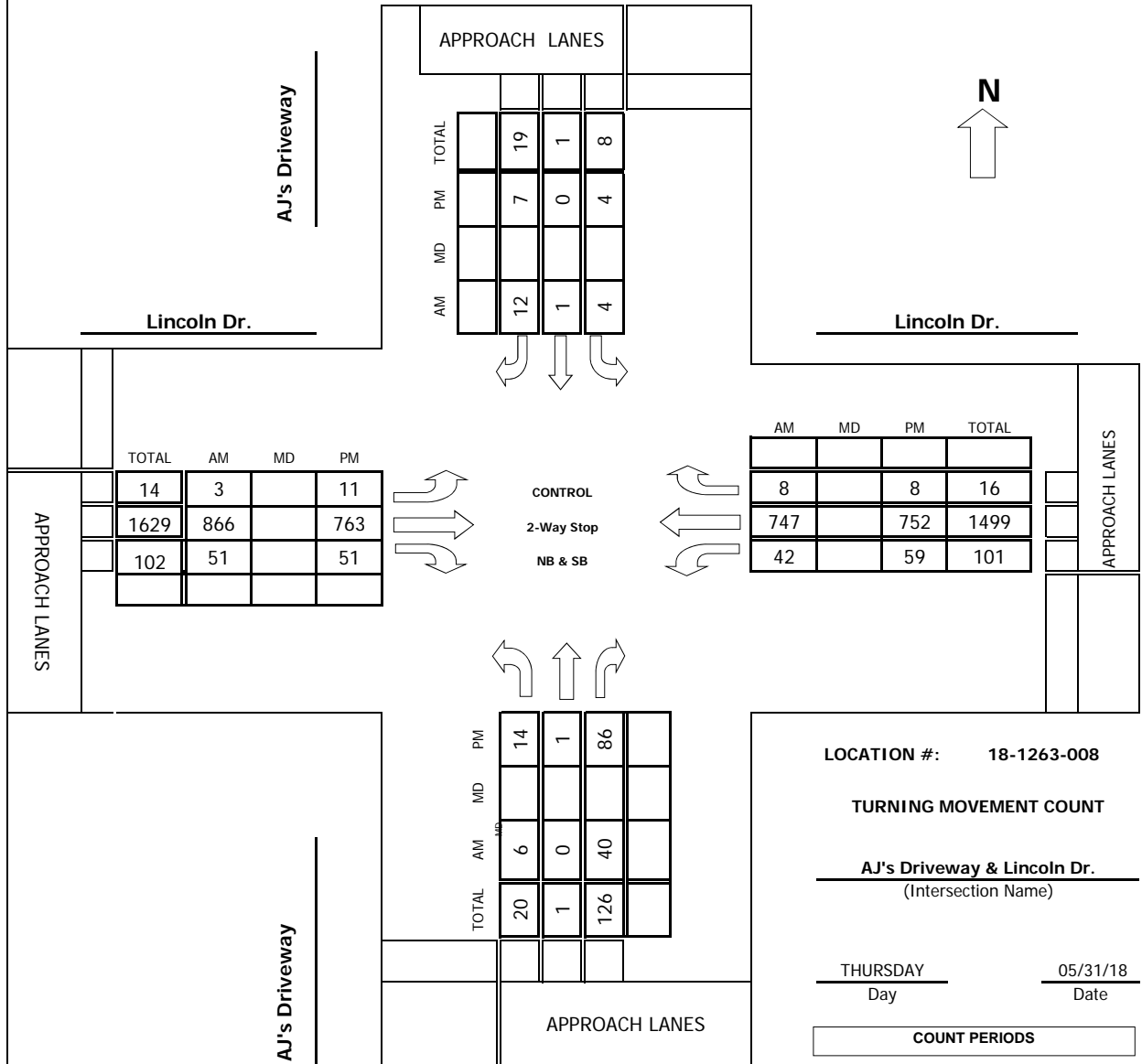

	TOTAL	AM	MD	PM
APPROACH LANES	14	3		11
	1629	866		763
	102	51		51

	AM	MD	PM	TOTAL
APPROACH LANES	8		8	16
	747		752	1499
	42		59	101

	TOTAL	AM	MD	PM
APPROACH LANES	20	6		14
	1	0		1
	126	40		86

LOCATION #: 18-1263-008

TURNING MOVEMENT COUNT

AJ's Driveway & Lincoln Dr.
 (Intersection Name)

THURSDAY **05/31/18**
 Day Date

COUNT PERIODS		
AM	700AM	- 900AM
NOON	-	-
PM	400PM	- 600PM

AM PEAK HOUR 800 AM
 NOON PEAK HOUR _____
 PM PEAK HOUR 430 PM

Project #: 18-1263-009

TMC SUMMARY OF Scottsdale Rd. & Lincoln Dr.

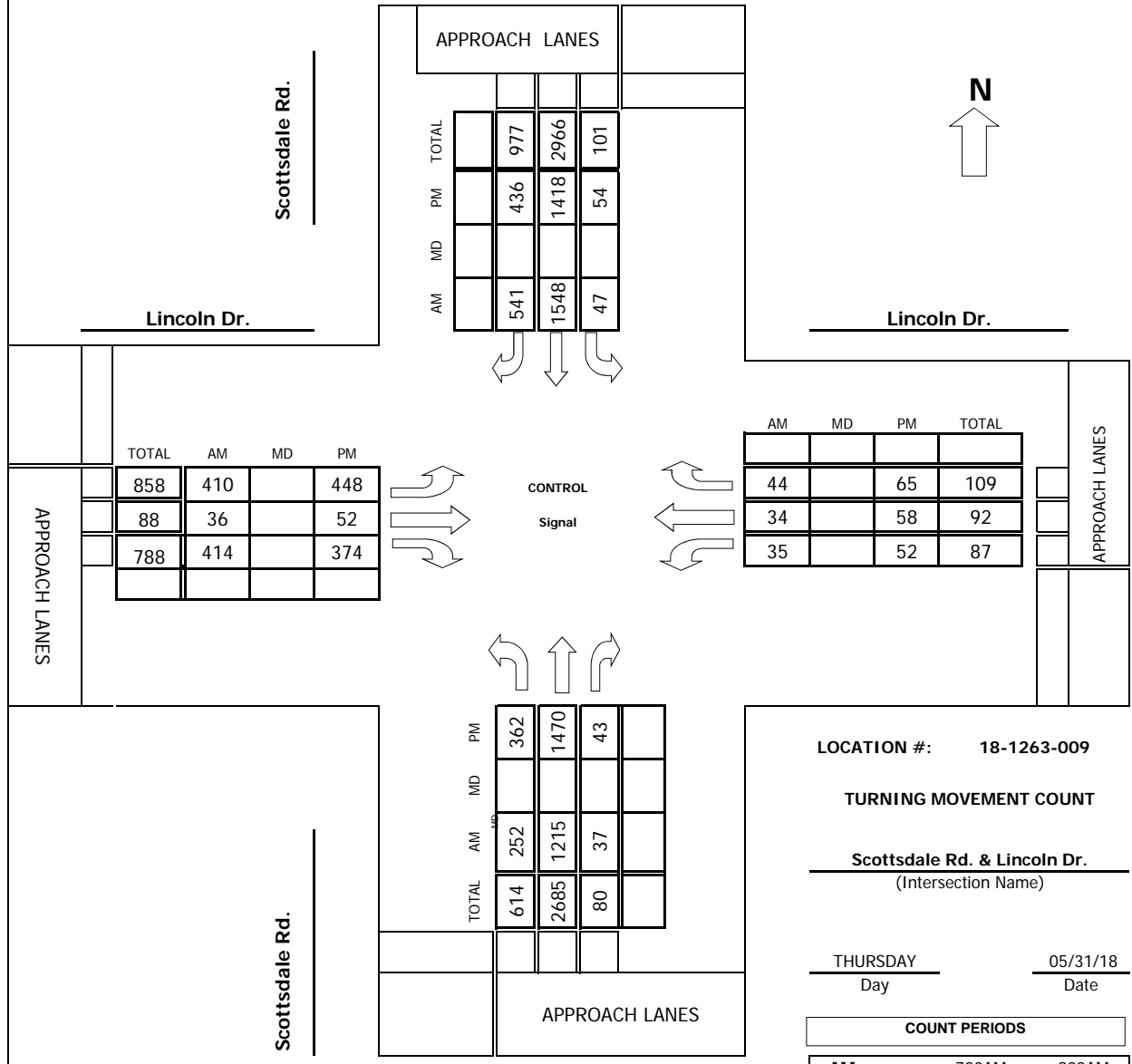

TOTAL	AM	MD	PM
858	410		448
88	36		52
788	414		374

AM	MD	PM	TOTAL
44		65	109
34		58	92
35		52	87

TOTAL	AM	MD	PM
614	252		362
2685	1215		1470
80	37		43

LOCATION #: 18-1263-009

TURNING MOVEMENT COUNT

Scottsdale Rd. & Lincoln Dr.
 (Intersection Name)

THURSDAY **05/31/18**
 Day Date

COUNT PERIODS		
AM	700AM	- 900AM
NOON	-	-
PM	400PM	- 600PM

AM PEAK HOUR 745 AM
 NOON PEAK HOUR _____
 PM PEAK HOUR 430 PM

APPENDIX C

EXISTING PEAK HOUR ANALYSIS

Smoke Tree Resort
Existing AM

1: Mockingbird Ln & Lincoln Drive
Timings

	EBT	WBL	WBT	NBL	NBT	SBL	SBT
Lane Group	EBL	EBT	WBL	WBT	NBL	NBT	SBL
Lane Configurations	1	4	4	4	4	4	4
Traffic Volume (vph)	212	815	19	801	5	33	70
Future Volume (vph)	212	815	19	801	5	33	70
Turn Type	pm-plt	NA	Perm	NA	pm+plt	NA	NA
Protected Phases	1	6	2	2	4	4	3
Permitted Phases	6	6	2	2	4	4	8
Detector Phase	1	6	2	2	4	4	3
Switch Phase	3.5	15.0	15.0	7.0	7.0	3.5	7.0
Minimum Initial (s)	8.0	27.0	27.0	33.5	33.5	8.0	33.5
Minimum Split (s)	27.0	77.0	50.0	44.0	44.0	9.0	53.0
Total Split (%)	20.8%	59.2%	38.5%	38.5%	33.8%	6.9%	40.8%
Yellow Time (s)	3.0	4.5	4.5	4.0	4.0	3.0	4.0
All-Red Time (s)	1.0	1.5	1.5	2.5	2.5	1.0	2.5
Lost Time Adjust (s)	0.0	0.0	0.0	0.0	0.0	0.0	0.0
Total Lost Time (s)	4.0	6.0	6.0	6.5	6.5	4.0	6.5
Lead/Lag	Lead	Lag	Lag	Lag	Lag	Lead	Lead
Lead-Lag Optimize?	Yes	Yes	Yes	Yes	Yes	Yes	Yes
Recall Mode	None	C-Max	C-Max	None	None	None	None
Act Effct Green (s)	95.1	93.1	74.8	74.8	17.2	26.9	24.4
Actuated g/C Ratio	0.73	0.72	0.58	0.58	0.13	0.21	0.19
v/C Ratio	0.51	0.37	0.06	0.46	0.10	0.22	0.31
Control Delay	10.5	8.4	18.2	19.1	49.2	36.8	43.6
Queue Delay	0.0	0.0	0.0	0.0	0.0	0.0	0.0
Total Delay	10.5	8.4	18.2	19.1	49.2	36.8	43.6
LOS	B	A	B	D	D	D	D
Approach Delay	8.8	8.8	19.0	38.1	49.4	49.4	49.4
Approach LOS	A	A	B	D	D	D	D
Intersection Summary							
Cycle Length: 130							
Actuated Cycle Length: 130							
Offset: 0 (0%), Referenced to phase 2:WBT and 6:EBTL, Start of Green							
Natural Cycle: 80							
Control Type: Actuated-Coordinated							
Maximum v/c Ratio: 0.83							
Intersection Signal Delay: 19.7							
Intersection Capacity Utilization 69.1%							
Analysis Period (min) 15							

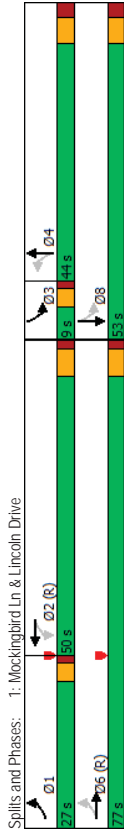

Smoke Tree Resort
Existing AM

1: Mockingbird Ln & Lincoln Drive
HCM 6th Signalized Intersection Summary

	EBL	EBT	EBR	WBL	WBT	WBR	NBL	NBT	NBR	SBL	SBT	SBR
Movement	EBL	EBT	EBR	WBL	WBT	WBR	NBL	NBT	NBR	SBL	SBT	SBR
Lane Configurations	1	4	4	4	4	4	4	4	4	4	4	4
Traffic Volume (veh/h)	212	815	29	19	801	39	5	33	15	70	85	216
Future Volume (veh/h)	212	815	29	19	801	39	5	33	15	70	85	216
Initial Q (Obs.) veh	0	0	0	0	0	0	0	0	0	0	0	0
Ped-Bike Adj(A_pbT)	1.00	1.00	1.00	1.00	1.00	1.00	1.00	1.00	1.00	1.00	1.00	1.00
Parking Bus, Adj	1.00	1.00	1.00	1.00	1.00	1.00	1.00	1.00	1.00	1.00	1.00	1.00
Work Zone On Approach	No	No	No	No	No	No	No	No	No	No	No	No
Adj Sat Flow (veh/h)	1870	1870	1870	1870	1870	1870	1870	1870	1870	1870	1870	1870
Adj Flow Rate, veh/h	236	906	32	21	890	43	6	37	17	78	94	240
Peak Hour Factor	0.90	0.90	0.90	0.90	0.90	0.90	0.90	0.90	0.90	0.90	0.90	0.90
Percent Heavy Veh. %	2	2	2	2	2	2	2	2	2	2	2	2
Cap. veh/h	439	2371	84	393	1984	96	88	191	88	301	106	270
Arrive On Green	0.07	0.68	0.68	0.58	0.58	0.58	0.16	0.16	0.16	0.04	0.23	0.23
Sat Flow, veh/h	1781	3501	124	597	3450	167	1046	1213	557	1781	466	1190
Grp Volume(v), veh/h	236	460	478	21	458	475	6	0	54	78	0	334
Grp Sat Flow(s),veh/h	1781	1777	1848	597	1777	1840	1046	0	1770	1781	0	1656
Q Serve(g.s), s	6.7	14.6	14.6	2.1	19.2	19.2	0.7	0.0	3.4	4.7	0.0	25.4
Cycle O Clear(g.c), s	6.7	14.6	14.6	3.4	19.2	17.1	0.0	0.0	3.4	4.7	0.0	25.4
Prop In Lane	1.00	0.07	1.00	1.00	0.09	1.00	0.09	1.00	0.31	1.00	0.0	0.72
V/C Ratio(X)	0.54	0.38	0.38	0.05	0.45	0.45	0.07	0.00	0.19	0.26	0.00	0.89
Avail Cap(c.a), veh/h	627	1203	1252	393	1022	1058	225	0	511	301	0	592
HCM Platoon Ratio	1.00	1.00	1.00	1.00	1.00	1.00	1.00	1.00	1.00	1.00	1.00	1.00
Upstream Filter(0)	1.00	1.00	1.00	1.00	1.00	1.00	1.00	1.00	1.00	1.00	1.00	1.00
Uniform Delay (d), s/veh	11.4	9.1	9.1	12.8	15.8	15.8	61.4	0.0	47.6	42.4	0.0	48.7
Incr Delay (d2), s/veh	1.0	0.9	0.9	0.3	1.4	1.4	0.3	0.0	0.3	0.5	0.0	10.2
Initial Q Delay(d3),s/veh	0.0	0.0	0.0	0.0	0.0	0.0	0.0	0.0	0.0	0.0	0.0	0.0
%ile BackOfQ(50%),veh/m	2.7	5.7	6.0	0.3	8.1	8.4	0.2	0.0	1.6	2.1	0.0	11.5
Unsig. Movement Delay, s/veh												
LnGrp Delay(d)S/veh	12.4	10.1	10.0	13.0	17.2	17.2	61.7	0.0	47.9	42.9	0.0	58.9
LnGrp LOS	B	B	B	B	B	B	E	A	D	D	A	E
Approach Vol. veh/h												
Approach Delay, s/veh												
Approach LOS												
Timer - Assigned Phs	1	2	3	4	6	8						
Phs Duration (G+Y+Rc), s	13.3	80.8	9.0	27.0	94.0	36.0						
Change Period (Y+Rc), s	4.0	6.0	4.0	6.5	6.0	6.5						
Max Green Setting (Gmax), s	23.0	44.0	5.0	37.5	71.0	46.5						
Max Q Clear Time (g_c+I1), s	8.7	21.2	6.7	19.1	16.6	27.4						
Green Ext Time (g_e), s	0.6	6.7	0.0	0.2	7.6	2.1						
Intersection Summary												
HCM 6th Ctrl Delay	21.0											
HCM 6th LOS	C											

Smoke Tree Resort
Existing AM

2: Quail Run Rd & Lincoln Drive
HCM 6th TWSC

Intersection														
Int Delay, s/veh	0.1													
Movement	EBL	EBT	EBR	WBL	WBT	WBR	NBL	NBT	NBR	SBL	SBT	SBR		
Lane Configurations	↖	↖	↖	↖	↖	↖								
Traffic Vol, veh/h	0	962	3	2	819	1	0	0	7	2	0	6		
Future Vol, veh/h	0	962	3	2	819	1	0	0	7	2	0	6		
Conflicting Peds, #/hr	0	0	0	0	0	0	0	0	0	0	0	0		
Sign Control	Free	Free	Free	Free	Free	Free	Stop	Stop	Stop	Stop	Stop	Stop		
RT Channelized	-	-	None	-	-	None	-	-	None	-	-	None		
Storage Length	25	-	-	25	-	-	-	-	-	-	-	-		
Veh in Median Storage, #	-	0	-	-	0	-	-	0	-	-	0	-		
Grade, %	-	0	-	-	0	-	-	0	-	-	0	-		
Peak Hour Factor	90	90	90	90	90	90	90	90	90	90	90	90		
Heavy Vehicles, %	2	2	2	2	2	2	2	2	2	2	2	2		
Mvmt Flow	0	1069	3	2	910	1	0	0	8	2	0	7		
Major/Minor	Major1	Major2	Minor1	Minor2	Minor1	Minor2	Minor1	Minor2	Minor1	Minor2	Minor1	Minor2		
Conflicting Flow All	911	0	0	1072	0	0	1530	1986	536	1450	1987	456		
Stage 1	-	-	-	-	-	-	1071	1071	-	915	915	-		
Stage 2	-	-	-	-	-	-	459	915	-	535	1072	-		
Critical Hdwy	4.14	-	-	4.14	-	-	7.54	6.54	6.94	7.54	6.54	6.94		
Critical Hdwy Stg 1	-	-	-	-	-	-	6.54	5.54	-	6.54	5.54	-		
Critical Hdwy Stg 2	-	-	-	-	-	-	6.54	5.54	-	6.54	5.54	-		
Follow-up Hdwy	2.22	-	-	2.22	-	-	3.52	4.02	3.32	3.52	4.02	3.32		
Pl Cap-1 Maneuver	743	-	-	646	-	-	80	60	489	92	60	551		
Stage 1	-	-	-	-	-	-	236	295	-	294	350	-		
Stage 2	-	-	-	-	-	-	551	350	-	497	295	-		
Platoon blocked, %	-	-	-	-	-	-	-	-	-	-	-	-		
Mov Cap-1 Maneuver	743	-	-	646	-	-	79	60	489	90	60	551		
Mov Cap-2 Maneuver	-	-	-	-	-	-	79	60	-	90	60	-		
Stage 1	-	-	-	-	-	-	236	295	-	294	349	-		
Stage 2	-	-	-	-	-	-	543	349	-	489	295	-		
Approach	EB	WB	NB	WB	NB	SB								
HCM Control Delay, s	0	0	0	0	12.5	20.4								
HCM LOS	B							C						
Minor Lane/Major Mvmt	NBLn1	EBL	EBT	EBR	WBL	WBT	WBR	SBLn1						
Capacity (veh/h)	489	743	-	-	646	-	-	242						
HCM Lane V/C Ratio	0.016	-	-	-	0.003	-	-	0.037						
HCM Control Delay (s)	12.5	0	-	-	10.6	-	-	20.4						
HCM Lane LOS	B	A	-	-	B	-	-	C						
HCM 95th %ile Q(veh)	0	0	-	-	0	-	-	0.1						

Smoke Tree Resort
Existing AM

3: Smole Tree West & Lincoln Dr
HCM 6th TWSC

Intersection														
Int Delay, s/veh	0													
Movement	EBT	EBR	WBL	WBT	NBL	NBR								
Lane Configurations	↖	↖	↖	↖	↖	↖								
Traffic Vol, veh/h	968	2	1	818	4	0								
Future Vol, veh/h	968	2	1	818	4	0								
Conflicting Peds, #/hr	0	0	0	0	0	0								
Sign Control	Free	Free	Free	Free	Free	Stop								
RT Channelized	-	None	-	None	-	None								
Storage Length	-	-	25	-	-	0								
Veh in Median Storage, #	0	-	-	0	0	0								
Grade, %	0	-	-	0	0	0								
Peak Hour Factor	90	90	90	90	90	90								
Heavy Vehicles, %	2	2	2	2	2	2								
Mvmt Flow	1076	2	1	909	4	0								
Major/Minor	Major1	Major2	Minor1	Minor2	Minor1	Minor2								
Conflicting Flow All	0	0	1078	0	1534	539								
Stage 1	-	-	-	-	1077	-								
Stage 2	-	-	-	-	457	-								
Critical Hdwy	-	-	4.14	-	6.84	6.94								
Critical Hdwy Stg 1	-	-	-	-	5.84	-								
Critical Hdwy Stg 2	-	-	-	-	5.84	-								
Follow-up Hdwy	-	-	2.22	-	3.52	3.32								
Pl Cap-1 Maneuver	-	-	643	-	107	487								
Stage 1	-	-	-	-	288	-								
Stage 2	-	-	-	-	604	-								
Platoon blocked, %	-	-	-	-	-	-								
Mov Cap-1 Maneuver	-	-	643	-	107	487								
Mov Cap-2 Maneuver	-	-	-	-	218	-								
Stage 1	-	-	-	-	287	-								
Stage 2	-	-	-	-	604	-								
Approach	EB	WB	NB											
HCM Control Delay, s	0	0	0	21.9										
HCM LOS	C													
Minor Lane/Major Mvmt	NBLn1	EBT	EBR	WBL	WBT									
Capacity (veh/h)	218	-	-	643	-									
HCM Lane V/C Ratio	0.02	-	-	0.002	-									
HCM Control Delay (s)	21.9	-	-	10.6	-									
HCM Lane LOS	C	-	-	B	-									
HCM 95th %ile Q(veh)	0.1	-	-	0	-									

Smoke Tree Resort
Existing AM

4: Smoke Tree East & Lincoln Dr
HCM 6th TWSC

Intersection	0									
Int Delay, s/veh	0									
Movement	EBT	EBR	WBL	WBT	NBL	NBR				
Lane Configurations	↕	↕	↕	↕	↕	↕				
Traffic Vol, veh/h	970	0	0	815	1	2				
Future Vol, veh/h	970	0	0	815	1	2				
Conflicting Peds, #/hr	0	0	0	0	0	0				
Sign Control	Free	Free	Free	Free	Stop	Stop				
RT Channelized	-	None	-	None	-	None				
Storage Length	-	-	25	-	0	-				
Veh in Median Storage, #	0	-	-	0	0	-				
Grade, %	0	-	-	0	0	-				
Peak Hour Factor	90	90	90	90	90	90				
Heavy Vehicles, %	2	2	2	2	2	2				
Mvmt Flow	1078	0	0	906	1	2				
Major/Minor	Major1	Major2	Minor1							
Conflicting Flow All	0	0	1078	0	1531	539				
Stage 1	-	-	-	-	1078	-				
Stage 2	-	-	-	-	-	453				
Critical Hdwy	-	-	4.14	-	6.84	6.94				
Critical Hdwy Stg 1	-	-	-	-	-	5.84				
Critical Hdwy Stg 2	-	-	-	-	-	5.84				
Follow-up Hdwy	-	-	2.22	-	3.52	3.32				
Pl Cap-1 Maneuver	-	-	643	-	108	487				
Stage 1	-	-	-	-	-	288				
Stage 2	-	-	-	-	-	607				
Platoon blocked, %	-	-	-	-	-	-				
Mov Cap-1 Maneuver	-	-	643	-	108	487				
Mov Cap-2 Maneuver	-	-	-	-	219	-				
Stage 1	-	-	-	-	-	288				
Stage 2	-	-	-	-	-	607				
Approach	EB	WB	NB							
HCM Control Delay, s	0	0	0	15.5	C					
HCM LOS							C			
Minor Lane/Major Mvmt	NBLn1	EBT	EBR	WBL	WBT					
Capacity (veh/h)	346	-	-	-	643	-				
HCM Lane V/C Ratio	0.01	-	-	-	-	-				
HCM Control Delay (s)	15.5	-	-	-	0	-				
HCM Lane LOS	C	-	-	-	A	-				
HCM 95th %tile Q(veh)	0	-	-	-	0	-				

Smoke Tree Resort
Existing AM

5: Lincoln Medical West & Lincoln Dr
HCM 6th TWSC

Intersection	0									
Int Delay, s/veh	0									
Movement	EBT	EBR	WBL	WBT	NBL	NBR				
Lane Configurations	↕	↕	↕	↕	↕	↕				
Traffic Vol, veh/h	968	4	0	815	0	3				
Future Vol, veh/h	968	4	0	815	0	3				
Conflicting Peds, #/hr	0	0	0	0	0	0				
Sign Control	Free	Free	Free	Free	Stop	Stop				
RT Channelized	-	None	-	None	-	None				
Storage Length	-	-	25	-	0	-				
Veh in Median Storage, #	0	-	-	0	0	-				
Grade, %	0	-	-	0	0	-				
Peak Hour Factor	90	90	90	90	90	90				
Heavy Vehicles, %	2	2	2	2	2	2				
Mvmt Flow	1076	4	0	906	0	3				
Major/Minor	Major1	Major2	Minor1							
Conflicting Flow All	0	0	1080	0	1531	540				
Stage 1	-	-	-	-	1078	-				
Stage 2	-	-	-	-	-	453				
Critical Hdwy	-	-	4.14	-	6.84	6.94				
Critical Hdwy Stg 1	-	-	-	-	-	5.84				
Critical Hdwy Stg 2	-	-	-	-	-	5.84				
Follow-up Hdwy	-	-	2.22	-	3.52	3.32				
Pl Cap-1 Maneuver	-	-	641	-	108	486				
Stage 1	-	-	-	-	-	288				
Stage 2	-	-	-	-	-	607				
Platoon blocked, %	-	-	-	-	-	-				
Mov Cap-1 Maneuver	-	-	641	-	108	486				
Mov Cap-2 Maneuver	-	-	-	-	219	-				
Stage 1	-	-	-	-	-	288				
Stage 2	-	-	-	-	-	607				
Approach	EB	WB	NB							
HCM Control Delay, s	0	0	0	12.5	B					
HCM LOS							B			
Minor Lane/Major Mvmt	NBLn1	EBT	EBR	WBL	WBT					
Capacity (veh/h)	486	-	-	-	641	-				
HCM Lane V/C Ratio	0.007	-	-	-	-	-				
HCM Control Delay (s)	12.5	-	-	-	0	-				
HCM Lane LOS	B	-	-	-	A	-				
HCM 95th %tile Q(veh)	0	-	-	-	0	-				

Smoke Tree Resort
Existing AM

6: Lincoln Medical East & Lincoln Dr
HCM 6th TWSC

Intersection												
Int Delay, s/veh												5.8
Movement	EBL	EBT	EBR	WBL	WBT	WBR	NBL	NBT	NBR	SBL	SBT	SBR
Lane Configurations	↔	↔	↔	↔	↔	↔	↔	↔	↔	↔	↔	↔
Traffic Vol, veh/h	967	2	5	815	0	3	0	3	0	0	0	0
Future Vol, veh/h	967	2	5	815	0	3	0	3	0	0	0	0
Conflicting Peds, #/hr	0	0	0	0	0	0	0	0	0	0	0	0
Sign Control	Free	Free	Free	Free	Free	Free	Stop	Stop	Stop	Stop	Stop	Stop
RT Channelized	-	None	-	None	-	None	-	None	-	None	-	None
Storage Length	-	-	25	-	-	-	-	-	-	-	-	-
Veh in Median Storage, #	0	-	-	0	0	-	-	-	-	-	-	-
Grade, %	0	-	-	-	-	-	-	-	-	-	-	-
Peak Hour Factor	90	90	90	90	90	90	90	90	90	90	90	90
Heavy Vehicles, %	2	2	2	2	2	2	2	2	2	2	2	2
Mvmt Flow	1074	2	6	906	0	3						
Major/Minor												
	Major1	Major2	Minor1	Minor2								
Conflicting Flow All	0	0	1076	0	1540	538						
Stage 1	-	-	-	-	1075	-						
Stage 2	-	-	-	-	465	-						
Critical Hdwy	-	-	4.14	-	6.84	6.94						
Critical Hdwy Stg 1	-	-	-	-	5.84	-						
Critical Hdwy Stg 2	-	-	-	-	5.84	-						
Follow-up Hdwy	-	-	2.22	-	3.52	3.32						
Plat Cap-1 Maneuver	-	-	644	-	106	488						
Stage 1	-	-	-	-	289	-						
Stage 2	-	-	-	-	599	-						
Platoon blocked, %	-	-	-	-	-	-						
Mov Cap-1 Maneuver	-	-	644	-	105	488						
Mov Cap-2 Maneuver	-	-	-	-	216	-						
Stage 1	-	-	-	-	286	-						
Stage 2	-	-	-	-	599	-						
Approach												
	EB	WB	WB	NB								
HCM Control Delay, s	0	0.1	0.1	12.4								
HCM LOS				B								
Minor Lane/Major Mvmt												
	NBLn1	EBT	EBR	WBL	WBT							
Capacity (veh/h)	488	-	-	644	-							
HCM Lane V/C Ratio	0.007	-	-	0.009	-							
HCM Control Delay (s)	12.4	-	-	10.6	-							
HCM Lane LOS	B	-	-	B	-							
HCM 95th %tile Q(veh)	0	-	-	0	-							

Smoke Tree Resort
Existing AM

7: Apartment Drwy & Lincoln Dr
HCM 6th TWSC

Intersection												
Int Delay, s/veh												5.8
Movement	EBL	EBT	EBR	WBL	WBT	WBR	NBL	NBT	NBR	SBL	SBT	SBR
Lane Configurations	↔	↔	↔	↔	↔	↔	↔	↔	↔	↔	↔	↔
Traffic Vol, veh/h	26	912	34	18	757	10	50	0	29	5	0	12
Future Vol, veh/h	26	912	34	18	757	10	50	0	29	5	0	12
Conflicting Peds, #/hr	0	0	0	0	0	0	0	0	0	0	0	0
Sign Control	Free	Free	Free	Free	Free	Free	Stop	Stop	Stop	Stop	Stop	Stop
RT Channelized	-	None	-	None	-	None	-	None	-	None	-	None
Storage Length	25	-	-	25	-	-	-	-	-	-	-	-
Veh in Median Storage, #	0	-	-	0	-	-	-	-	-	-	-	-
Grade, %	0	-	-	-	-	-	-	-	-	-	-	-
Peak Hour Factor	90	90	90	90	90	90	90	90	90	90	90	90
Heavy Vehicles, %	2	2	2	2	2	2	2	2	2	2	2	2
Mvmt Flow	29	1013	38	20	841	11	56	0	32	6	0	13
Major/Minor												
	Major1	Major2	Minor1	Minor2								
Conflicting Flow All	852	0	0	1051	0	0	1551	1982	526	1452	-	426
Stage 1	-	-	-	-	-	-	1090	1090	-	887	-	-
Stage 2	-	-	-	-	-	-	461	892	-	565	-	-
Critical Hdwy	4.14	-	-	4.14	-	-	7.54	6.54	6.94	7.54	-	6.94
Critical Hdwy Stg 1	-	-	-	-	-	-	6.54	5.54	-	6.54	-	-
Critical Hdwy Stg 2	-	-	-	-	-	-	6.54	5.54	-	6.54	-	-
Follow-up Hdwy	2.22	-	-	2.22	-	-	3.52	4.02	3.32	3.52	-	3.32
Plat Cap-1 Maneuver	783	-	-	658	-	-	77	61	496	92	0	577
Stage 1	-	-	-	-	-	-	230	289	-	305	0	-
Stage 2	-	-	-	-	-	-	550	358	-	477	0	-
Platoon blocked, %	-	-	-	-	-	-	-	-	-	-	-	-
Mov Cap-1 Maneuver	783	-	-	658	-	-	71	57	496	82	-	577
Mov Cap-2 Maneuver	-	-	-	-	-	-	71	57	-	82	-	-
Stage 1	-	-	-	-	-	-	221	278	-	294	-	-
Stage 2	-	-	-	-	-	-	521	347	-	429	-	-
Approach												
	EB	WB	WB	NB	SB							
HCM Control Delay, s	0.3	0.2	0.2	124.4	23.4							
HCM LOS				F	C							
Minor Lane/Major Mvmt												
	NBLn1	EBL	EBT	EBR	WBL	WBT	WBR	SBLn1	SBLn2			
Capacity (veh/h)	104	783	-	-	658	-	-	82	577			
HCM Lane V/C Ratio	0.844	0.037	-	-	0.03	-	-	0.068	0.023			
HCM Control Delay (s)	124.4	9.8	-	-	10.6	-	-	52.1	11.4			
HCM Lane LOS	F	A	-	-	B	-	-	F	B			
HCM 95th %tile Q(veh)	4.8	0.1	-	-	0.1	-	-	0.2	0.1			

Smoke Tree Resort
Existing AM

8: AJ's Drwy & Lincoln Dr
HCM 6th TWSC

Intersection	1																
Init Delay, s/veh																	
Movement	EBL	EBT	EBR	WBL	WBT	WBR	NBL	NBT	NBR	SBL	SBT	SBR					
Lane Configurations	↔	↔	↔	↔	↔	↔	↔	↔	↔	↔	↔	↔	↔	↔	↔	↔	
Traffic Vol, veh/h	3 892	53	43	769	8	6	0	41	4	1	12	↔	↔	↔	↔	↔	
Future Vol, veh/h	3 892	53	43	769	8	6	0	41	4	1	12	↔	↔	↔	↔	↔	
Conflicting Peds, #/hr	0	0	0	0	0	0	0	0	0	0	0	0	0	0	0	0	
Sign Control	Free Free Free Free Free Free Free Free Free Free Free Free																
RT Channelized	- - None - - None - - None - - None - - None - - None																
Storage Length	25 - - - 25 - - - 0 - - - 0 - - - 0 - - - 0 - - -																
Veh in Median Storage, #	- - - - - 0 - - - 0 - - - 0 - - - 0 - - - 0 - - -																
Grade, %	- - - - - 0 - - - 0 - - - 0 - - - 0 - - - 0 - - -																
Peak Hour Factor	90	90	90	90	90	90	90	90	90	90	90	90	90	90	90	90	
Heavy Vehicles, %	2	2	2	2	2	2	2	2	2	2	2	2	2	2	2	2	
Mgmt Flow	3 991	59	48	854	9	7	0	46	4	1	13	↔	↔	↔	↔	↔	
Major/Minor	Major1	Major2					Minor1					Minor2					
Conflicting Flow All	863	0	0	1050	0	0	1551	1986	525	1457	2011	432					
Stage 1	-	-	-	-	-	-	-	1027	1027	-	955	955	-				
Stage 2	-	-	-	-	-	-	-	524	959	-	502	1056	-				
Critical Hdwy	4:14	-	-	4:14	-	-	7:54	6:54	6:94	7:54	6:54	6:94	-				
Critical Hdwy Slg 1	-	-	-	-	-	-	-	6:54	5:54	-	6:54	5:54	-				
Critical Hdwy Slg 2	-	-	-	-	-	-	-	6:54	5:54	-	6:54	5:54	-				
Follow-up Hdwy	2:22	-	-	2:22	-	-	3:52	4:02	3:32	3:52	4:02	3:32	-				
Pl Cap-1 Maneuver	7:75	-	-	6:59	-	-	7:7	6:0	4:97	9:1	5:8	5:72	-				
Stage 1	-	-	-	-	-	-	-	251	310	-	278	335	-				
Stage 2	-	-	-	-	-	-	-	504	334	-	520	300	-				
Platoon blocked, %	-																
Mov Cap-1 Maneuver	7:75	-	-	6:59	-	-	7:0	5:5	4:97	7:8	5:4	5:72	-				
Mov Cap-2 Maneuver	-	-	-	-	-	-	-	7:0	5:5	-	7:8	5:4	-				
Stage 1	-	-	-	-	-	-	-	250	309	-	277	311	-				
Stage 2	-	-	-	-	-	-	-	455	310	-	471	299	-				
Approach	EB	WB	NB	WB	NB	SB	SB	SB	SB	SB	SB	SB	SB				
HCM Control Delay, s	0	0.6	0.6	20.9	20.9	22	22	C	C	C	C	C	C				
HCM LOS														C	C	C	C
Minor Lane/Major Mvmt	NBLn1	EBL	EBT	EBR	WBL	WBT	WBR	SBLn1	SBLn2	SBLn2	SBLn2	SBLn2	SBLn2				
Capacity (veh/h)	279	775	-	-	659	-	-	78	572	-	78	572	-				
HCM Lane V/C Ratio	0.187	0.004	-	-	0.073	-	-	0.057	0.023	-	0.057	0.023	-				
HCM Control Delay (s)	20.9	9.7	-	-	10.9	-	-	53.9	11.4	-	53.9	11.4	-				
HCM Lane LOS	C	A	-	-	B	-	-	F	B	-	F	B	-				
HCM 95th %ile Q(veh)	0.7	0	-	-	0.2	-	-	0.2	0.1	-	0.2	0.1	-				

Smoke Tree Resort
Existing AM

9: Scottsdale Rd & Lincoln Dr
Timings

Lane Group	EBL	EBT	EBR	WBL	WBT	WBR	NBL	NBT	SBL	SBT	SBR
Lane Configurations	↔	↔	↔	↔	↔	↔	↔	↔	↔	↔	↔
Traffic Volume (vph)	422	37	426	36	35	260	1251	48	1594	557	↔
Future Volume (vph)	422	37	426	36	35	260	1251	48	1594	557	↔
Turn Type	Split	NA	pm+ov	Split	NA	pm+ov	Prot	NA	Prot	NA	pm+ov
Protected Phases	4	4	5	8	8	5	2	1	6	4	4
Permitted Phases											
Detector Phase	4	4	5	8	8	5	2	1	6	4	4
Switch Phase											
Minimum Initial (s)	7.0	7.0	7.0	7.0	7.0	7.0	10.0	5.0	10.0	7.0	7.0
Minimum Split (s)	13.0	13.0	13.0	13.0	13.0	13.0	16.7	11.0	16.0	13.0	13.0
Total Split (s)	30.0	30.0	30.0	13.0	13.0	30.0	73.0	14.0	57.0	30.0	30.0
Total Split (%)	23.1%	23.1%	23.1%	10.0%	10.0%	23.1%	56.2%	10.8%	43.8%	23.1%	23.1%
Yellow Time (s)	4.0	4.0	4.0	3.6	3.6	4.0	4.7	3.3	4.7	4.0	4.0
All-Red Time (s)	1.5	1.5	1.5	2.0	2.0	1.5	1.0	2.0	1.0	1.5	1.5
Lost Time Adjust (s)	0.0	0.0	0.0	0.0	0.0	0.0	0.0	0.0	0.0	0.0	0.0
Total Lost Time (s)	5.5	5.5	5.5	5.6	5.6	5.5	5.7	5.3	5.7	5.5	5.5
Lead/Lag	Lead										
Lead-Lag Optimize?	None										
Recall Mode	None										
Act Effct Green (s)	23.0	23.0	39.9	7.2	7.2	16.9	72.2	7.5	60.6	89.3	None
Actuated v/c Ratio	0.18	0.18	0.31	0.06	0.06	0.13	0.56	0.06	0.47	0.69	0.69
v/c Ratio	0.85	0.86	0.89	0.41	0.39	0.65	0.51	0.52	0.75	0.53	0.53
Control Delay	77.2	77.4	44.6	72.1	34.3	60.0	19.6	77.2	32.1	8.4	8.4
Queue Delay	0.0	0.0	0.0	0.0	0.0	0.0	0.0	0.0	0.0	0.0	0.0
Total Delay	77.2	77.4	44.6	72.1	34.3	60.0	19.6	77.2	32.1	8.4	8.4
LOS	E	E	D	E	C	E	B	E	C	A	A
Approach Delay	61.6										
Approach LOS	E										
Intersection Summary	E										
Cycle Length: 130	E										
Actuated Cycle Length: 130	E										
Offset: 0 (0%), Referenced to phase 6:SBT, Start of Green	E										
Natural Cycle: 90	E										
Control Type: Actuated-Coordinated	E										
Maximum v/c Ratio: 0.89	E										
Intersection Signal Delay: 33.8	E										
Intersection Capacity Utilization 77.0%	E										
Analysis Period (min): 15	E										

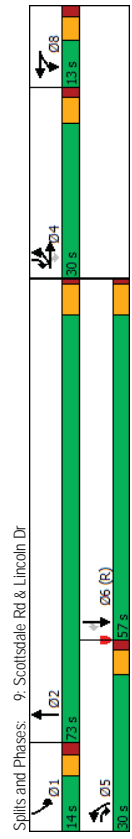

Smoke Tree Resort
Existing AM

9: Scottsdale Rd & Lincoln Dr
HCM 6th Signalized Intersection Summary

Movement	EBL	EBT	EBR	WBL	WBT	WBR	NBL	NBT	NBR	SBL	SBT	SBR
Lane Configurations	4	4	4	4	4	4	4	4	4	4	4	4
Traffic Volume (veh/h)	422	37	426	36	35	45	260	1251	38	48	1594	557
Future Volume (veh/h)	422	37	426	36	35	45	260	1251	38	48	1594	557
Initial Q (Qb), veh	0	0	0	0	0	0	0	0	0	0	0	0
Ped-Bike Adj(A_pb1)	1.00	1.00	1.00	1.00	1.00	1.00	1.00	1.00	1.00	1.00	1.00	1.00
Parking Bus, Adj	1.00	1.00	1.00	1.00	1.00	1.00	1.00	1.00	1.00	1.00	1.00	1.00
Work Zone On Approach	No	No	No	No	No	No	No	No	No	No	No	No
Adj Sat Flow, veh/h	1870	1870	1870	1870	1870	1870	1870	1870	1870	1870	1870	1870
Adj Flow Rate, veh/h	498	0	473	40	39	50	289	1390	42	53	1771	619
Peak Hour Factor	0.90	0.90	0.90	0.90	0.90	0.90	0.90	0.90	0.90	0.90	0.90	0.90
Percent Heavy Veh, %	2	2	2	2	2	2	2	2	2	2	2	2
Cap, veh/h	671	0	458	95	95	85	348	2336	71	68	2015	924
Arrive On Green	0.19	0.00	0.19	0.05	0.05	0.05	0.10	0.46	0.46	0.04	0.39	0.39
Sat Flow, veh/h	3563	0	1585	1781	1777	1585	3456	5093	154	1781	5106	1585
Grp Volume(v), veh/h	498	0	473	40	39	50	289	929	503	53	1771	619
Grp Sat Flow(s),veh/h	1781	0	1585	1781	1777	1585	1728	1702	1843	1781	1702	1585
Q Serve(g_s), s	17.1	0.0	24.5	2.8	2.8	2.8	4.0	10.7	26.4	3.8	41.8	34.7
Cycle Q Clear(g_c), s	17.1	0.0	24.5	2.8	2.8	2.8	4.0	10.7	26.4	3.8	41.8	34.7
Prop In Lane	1.00	1.00	1.00	1.00	1.00	1.00	1.00	1.00	1.00	1.00	1.00	1.00
Lane Grp Cap(c), veh/h	671	0	458	95	95	85	348	1561	845	68	2015	924
V/C Ratio(X)	0.74	0.00	1.03	0.42	0.41	0.59	0.83	0.60	0.60	0.78	0.88	0.67
Avail Cap(c_a), veh/h	671	0	458	101	101	90	651	1762	954	119	2015	924
HCM Platoon Ratio	1.00	1.00	1.00	1.00	1.00	1.00	1.00	1.00	1.00	1.00	1.00	1.00
Upstream Filter(i)	1.00	0.00	1.00	1.00	1.00	1.00	1.00	1.00	1.00	1.00	1.00	1.00
Uniform Delay (d), s/veh	49.8	0.0	46.2	59.6	59.6	60.1	57.4	26.2	26.2	62.0	36.5	18.5
Incr Delay (d2), s/veh	3.9	0.0	50.4	1.1	1.1	5.4	2.0	0.2	0.4	6.9	5.9	3.9
Initial Q Delay(Q3),s/veh	0.0	0.0	0.0	0.0	0.0	0.0	0.0	0.0	0.0	0.0	0.0	0.0
%ile BackOf(50%),veh/h	8.0	0.0	21.1	1.3	1.3	1.7	4.8	10.7	11.6	1.9	18.2	20.2
Unsig. Movement Delay, s/veh												
LnGrp Delay(d)s/veh	53.7	0.0	96.6	60.7	60.6	65.5	59.3	26.4	26.6	68.8	42.3	22.4
LnGrp LOS	D	A	F	E	E	E	E	C	C	E	D	C
Approach Vol, veh/h				129				1721				2443
Approach Delay, s/veh				62.5				32.0				37.9
Approach LOS				E				C				D
Timer - Assigned Phs	1	2	4	5	6	8						
Phs Duration (G+Y+Rc), s	10.3	65.3	30.0	18.6	57.0	12.5						
Change Period (Y+Rc), s	* 5.3	5.7	5.5	5.5	5.7	5.6						
Max Green Setting (Gmax), s	* 8.7	67.3	24.5	24.5	51.3	7.4						
Max Q Clear Time (g_c+1T), s	5.8	28.4	26.5	12.7	43.8	6.0						
Green Ext Time (g_e), s	0.0	2.1	0.0	0.4	2.5	0.0						
Intersection Summary												
HCM 6th Ctrl Delay												
HCM 6th LOS												
Notes												
User approved pedestrian interval to be less than phase max green.												
User approved volume balancing among the lanes for turning movement.												
* HCM 6th computational engine requires equal clearance times for the phases crossing the barrier.												

Smoke Tree Resort
Existing PM

1: Mockingbird Ln & Lincoln Drive
Timings

	EBT	WBL	WBT	NBL	NBT	SBL	SBT
Lane Group	EBL	EBT	WBL	WBT	NBL	NBT	SBL
Lane Configurations	1	1	1	1	1	1	1
Traffic Volume (vph)	228	764	12	805	7	60	57
Future Volume (vph)	228	764	12	805	7	60	57
Turn Type	pm-plt	NA	Perm	NA	Perm	NA	pm+plt
Protected Phases	1	6	2	2	4	4	3
Permitted Phases	6	6	2	2	4	4	8
Detector Phase	1	6	2	2	4	4	3
Switch Phase							
Minimum Initial (s)	4.0	15.0	15.0	7.0	7.0	4.0	7.0
Minimum Split (s)	8.0	27.0	27.0	33.5	33.5	8.0	33.5
Total Split (s)	31.0	88.0	57.0	34.0	34.0	8.0	42.0
Total Split (%)	23.8%	67.7%	43.8%	43.8%	26.2%	6.2%	32.3%
Yellow Time (s)	3.0	4.5	4.5	4.0	4.0	3.0	4.0
All-Red Time (s)	1.0	1.5	1.5	2.5	2.5	1.0	2.5
Lost Time Adjust (s)	0.0	0.0	0.0	0.0	0.0	0.0	0.0
Total Lost Time (s)	4.0	6.0	6.0	6.5	6.5	4.0	6.5
Lead/Lag	Lead	Lag	Lag	Lag	Lag	Lead	Lead
Lead-Lag Optimize?	Yes	Yes	Yes	Yes	Yes	Yes	Yes
Recall Mode	None	C-Max	C-Max	None	None	None	None
Act Effct Green (s)	102.4	100.4	84.3	107.7	107.7	19.6	17.1
Actuated g/C Ratio	0.79	0.77	0.65	0.65	0.08	0.15	0.13
v/c Ratio	0.53	0.32	0.03	0.42	0.10	0.51	0.37
Control Delay	8.1	5.3	11.8	13.0	55.7	63.3	32.6
Queue Delay	0.0	0.0	0.0	0.0	0.0	0.0	0.0
Total Delay	8.1	5.3	11.8	13.0	55.7	63.3	32.6
LOS	A	A	B	E	E	D	C
Approach Delay	5.9		13.0	62.6		37.3	
Approach LOS	A		B	E	E	D	
Intersection Summary							
Cycle Length: 130							
Actuated Cycle Length: 130							
Offset: 0 (0%), Referenced to phase 2:WBL and 6:EBTL, Start of Green							
Natural Cycle: 90							
Control Type: Actuated-Coordinated							
Maximum v/c Ratio: 0.66							
Intersection Signal Delay: 14.2							
Intersection Capacity Utilization 61.8%							
Analysis Period (min) 15							

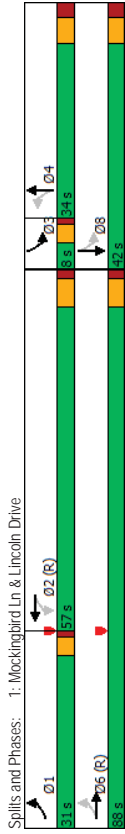

Smoke Tree Resort
Existing PM

1: Mockingbird Ln & Lincoln Drive
HCM 6th Signalized Intersection Summary

	EBL	EBT	EBR	WBL	WBT	WBR	NBL	NBT	NBR	SBL	SBT	SBR
Movement	EBL	EBT	EBR	WBL	WBT	WBR	NBL	NBT	NBR	SBL	SBT	SBR
Lane Configurations	1	1	1	1	1	1	1	1	1	1	1	1
Traffic Volume (veh/h)	228	764	28	12	805	56	7	60	10	57	46	145
Future Volume (veh/h)	228	764	28	12	805	56	7	60	10	57	46	145
Initial Q (Obs.) veh	0	0	0	0	0	0	0	0	0	0	0	0
Pod-Bike Adj(A_pbT)	1.00	1.00	1.00	1.00	1.00	1.00	1.00	1.00	1.00	1.00	1.00	1.00
Parking Bus, Adj	1.00	1.00	1.00	1.00	1.00	1.00	1.00	1.00	1.00	1.00	1.00	1.00
Work Zone On Approach	No	No	No	No	No	No	No	No	No	No	No	No
Adj Sat Flow (veh/h)	1870	1870	1870	1870	1870	1870	1870	1870	1870	1870	1870	1870
Adj Flow Rate, veh/h	253	849	31	13	894	62	8	67	11	63	51	161
Peak Hour Factor	0.90	0.90	0.90	0.90	0.90	0.90	0.90	0.90	0.90	0.90	0.90	0.90
Percent Heavy Veh, %	2	2	2	2	2	2	2	2	2	2	2	2
Cap. veh/h	484	2635	96	471	2222	154	84	139	23	173	59	188
Arrive On Green	0.06	0.75	0.75	0.66	0.66	0.66	0.09	0.09	0.09	0.03	0.15	0.15
Sat Flow, veh/h	1781	3497	128	631	3371	234	1170	1567	257	1781	396	1250
Grp Volume(v), veh/h	253	431	449	13	471	485	8	78	63	0	212	0
Grp Sat Flow(s),veh/h	1781	1777	1847	631	1777	1828	1170	0	1824	1781	0	1645
Q Serve(g.s), s	5.6	10.3	10.3	0.9	16.0	16.0	0.9	0.0	5.3	4.0	0.0	16.3
Cycle Q Clear(g.c), s	5.6	10.3	10.3	0.9	16.0	16.0	0.9	0.0	5.3	4.0	0.0	16.3
Prop In Lane	1.00	0.07	1.00	1.00	1.00	1.00	1.00	0.14	1.00	1.00	0.76	0.247
Lane Grp Cap(c), veh/h	484	1339	1392	471	1171	1205	84	0	162	173	0	247
v/c Ratio(X)	0.52	0.32	0.32	0.03	0.40	0.40	0.10	0.00	0.48	0.36	0.00	0.86
Avail Cap(c.a), veh/h	740	1339	1392	471	1171	1205	228	0	386	173	0	449
HCM Platoon Ratio	1.00	1.00	1.00	1.00	1.00	1.00	1.00	1.00	1.00	1.00	1.00	1.00
Upstream Filter(i)	1.00	1.00	1.00	1.00	1.00	1.00	1.00	1.00	1.00	1.00	1.00	1.00
Uniform Delay (d), s/veh	7.4	5.2	5.2	7.7	10.3	10.3	62.3	0.0	56.4	50.9	0.0	53.9
Incr Delay (d2), s/veh	0.9	0.6	0.6	0.1	1.0	1.0	0.5	0.0	2.2	1.3	0.0	8.4
Initial Q Delay(g3),s/veh	0.0	0.0	0.0	0.0	0.0	0.0	0.0	0.0	0.0	0.0	0.0	0.0
%ile BackOfQ(50%),veh/ln	2.0	3.7	3.8	0.1	6.4	6.6	0.3	0.0	2.5	1.9	0.0	7.3
Unsig. Movement Delay, s/veh												
LnGrp Delay(d)s/veh	8.3	5.8	5.8	7.8	11.3	11.3	62.8	0.0	58.6	52.1	0.0	62.3
LnGrp LOS	A	A	A	A	B	B	E	A	E	D	A	E
Approach Vol, veh/h	1133			969			86				275	
Approach Delay, s/veh	6.4			11.3			59.0				60.0	
Approach LOS	A			B			E				E	
Timer - Assigned Phs	1	2	3	4	6	8						
Phs Duration (G+Y+Rc), s	12.3	91.7	8.0	18.0	104.0	26.0						
Change Period (Y+Rc), s	4.0	6.0	4.0	6.5	6.0	6.5						
Max Green Setting (Gmax), s	27.0	51.0	4.0	27.5	82.0	35.5						
Max Q Clear Time (g_c+I1), s	7.6	18.0	6.0	11.2	12.3	18.3						
Green EXT Time (g_e), s	0.7	7.5	0.0	0.3	6.9	1.1						
Intersection Summary												
HCM 6th Ctrl Delay	16.1											
HCM 6th LOS	B											

Smoke Tree Resort
Existing PM

2: Quail Run Rd & Lincoln Drive
HCM 6th TWSC

Intersection													
Init Delay, s/w/h													0
Movement	EBL	EBT	EBR	WBL	WBT	WBR	NBL	NBT	NBR	SBL	SBT	SBR	
Lane Configurations	↖	↖	↖	↖	↖	↖	↖	↖	↖	↖	↖	↖	↖
Traffic Vol, veh/h	0	846	1	0	871	0	0	0	0	2	0	0	0
Future Vol, veh/h	0	846	1	0	871	0	0	0	0	2	0	0	0
Conflicting Peds, #/hr	0	0	0	0	0	0	0	0	0	0	0	0	0
Sign Control	Free	Free	Free	Free	Free	Free	Stop	Stop	Stop	Stop	Stop	Stop	
RT Channelized	-	-	-	-	-	-	-	-	-	-	-	-	None
Storage Length	25	-	-	25	-	-	-	-	-	-	-	-	-
Veh in Median Storage, #	-	0	-	-	0	-	-	0	-	-	-	0	-
Grade, %	-	0	-	-	0	-	-	0	-	-	-	0	-
Peak Hour Factor	90	90	90	90	90	90	90	90	90	90	90	90	
Heavy Vehicles, %	2	2	2	2	2	2	2	2	2	2	2	2	
Mvmt Flow	0	940	1	0	968	0	0	0	0	2	0	0	0
Major/Minor	Major1	Major2	Minor1	Minor2									
Conflicting Flow All	968	0	0	941	0	0	1425	1909	471	1438	1909	484	
Stage 1	-	-	-	-	-	-	941	941	-	968	968	-	
Stage 2	-	-	-	-	-	-	484	968	-	470	941	-	
Critical Hdwy	4.14	-	-	4.14	-	-	7.54	6.54	6.94	7.54	6.54	6.94	
Critical Hdwy Stg 1	-	-	-	-	-	-	6.54	5.54	-	6.54	5.54	-	
Critical Hdwy Stg 2	-	-	-	-	-	-	6.54	5.54	-	6.54	5.54	-	
Follow-up Hdwy	2.22	-	-	2.22	-	-	3.52	4.02	3.32	3.52	4.02	3.32	
Pl Cap-1 Maneuver	707	-	-	724	-	-	96	68	539	94	68	529	
Stage 1	-	-	-	-	-	-	283	340	-	273	330	-	
Stage 2	-	-	-	-	-	-	533	330	-	543	340	-	
Platoon blocked, %	-	-	-	-	-	-	-	-	-	-	-	-	
Mov Cap-1 Maneuver	707	-	-	724	-	-	96	68	539	94	68	529	
Mov Cap-2 Maneuver	-	-	-	-	-	-	96	68	-	94	68	-	
Stage 1	-	-	-	-	-	-	283	340	-	273	330	-	
Stage 2	-	-	-	-	-	-	533	330	-	541	340	-	
Approach	EB	WB	NB	SB									
HCM Control Delay, s	0	0	11.7	0									
HCM LOS			B	A									
Minor Lane/Major Mvmt	NBLn1	EBL	EBT	EBR	WBL	WBT	WBR	SBLn1					
Capacity (veh/h)	539	707	-	-	724	-	-	-					
HCM Lane V/C Ratio	0.004	-	-	-	-	-	-	-					
HCM Control Delay (s)	11.7	0	-	-	0	-	-	0					
HCM Lane LOS	B	A	-	-	A	-	-	A					
HCM 95th %ile Q(veh)	0	0	-	-	0	-	-	-					

Smoke Tree Resort
Existing PM

3: Smole Tree West & Lincoln Dr
HCM 6th TWSC

Intersection															
Init Delay, s/w/h													0		
Movement	EBT	EBR	WBL	WBT	NBL	NBR									
Lane Configurations	↖	↖	↖	↖	↖	↖									
Traffic Vol, veh/h	848	1	0	870	1	0									
Future Vol, veh/h	848	1	0	870	1	0									
Conflicting Peds, #/hr	0	0	0	0	0	0									
Sign Control	Free	Free	Free	Free	Stop	Stop									
RT Channelized	-	-	-	-	-	-									
Storage Length	-	-	25	-	-	-									
Veh in Median Storage, #	0	-	-	0	0	-									
Grade, %	0	-	-	0	0	-									
Peak Hour Factor	90	90	90	90	90	90									
Heavy Vehicles, %	2	2	2	2	2	2									
Mvmt Flow	942	1	0	967	1	0									
Major/Minor	Major1	Major2	Minor1												
Conflicting Flow All	0	0	943	0	1427	472									
Stage 1	-	-	-	-	943	-									
Stage 2	-	-	-	-	484	-									
Critical Hdwy	-	-	4.14	-	6.84	6.94									
Critical Hdwy Stg 1	-	-	-	-	5.84	-									
Critical Hdwy Stg 2	-	-	-	-	5.84	-									
Follow-up Hdwy	-	-	2.22	-	3.52	3.32									
Pl Cap-1 Maneuver	-	-	723	-	126	538									
Stage 1	-	-	-	-	339	-									
Stage 2	-	-	-	-	585	-									
Platoon blocked, %	-	-	-	-	-	-									
Mov Cap-1 Maneuver	-	-	723	-	126	538									
Mov Cap-2 Maneuver	-	-	-	-	248	-									
Stage 1	-	-	-	-	339	-									
Stage 2	-	-	-	-	585	-									
Approach	EB	WB	NB												
HCM Control Delay, s	0	0	19.6												
HCM LOS			C												
Minor Lane/Major Mvmt	NBLn1	EBT	EBR	WBL	WBT										
Capacity (veh/h)	248	-	-	723	-										
HCM Lane V/C Ratio	0.004	-	-	-	-										
HCM Control Delay (s)	19.6	-	-	0	-										
HCM Lane LOS	C	-	-	A	-										
HCM 95th %ile Q(veh)	0	-	-	0	-										

Smoke Tree Resort
Existing PM

4: Smoke Tree East & Lincoln Dr
HCM 6th TWSC

Intersection	0									
Int Delay, s/veh	0									
Movement	EBT	EBR	WBL	WBT	NBL	NBR				
Lane Configurations	↕	↕	↕	↕	↕	↕				
Traffic Vol, veh/h	847	1	2	870	1	2				
Future Vol, veh/h	847	1	2	870	1	2				
Conflicting Peds, #/hr	0	0	0	0	0	0				
Sign Control	Free	Free	Free	Free	Stop	Stop				
RT Channelized	-	None	-	None	-	None				
Storage Length	-	-	25	-	-	0				
Veh in Median Storage, #	0	-	-	0	0	-				
Grade, %	0	-	-	0	0	-				
Peak Hour Factor	90	90	90	90	90	90				
Heavy Vehicles, %	2	2	2	2	2	2				
Mvmt Flow	941	1	2	967	1	2				
Major/Minor	Major1	Major2	Minor1							
Conflicting Flow All	0	0	942	0	1430	471				
Stage 1	-	-	942	-	-	488				
Stage 2	-	-	-	-	-	-				
Critical Hdwy	-	-	4.14	-	6.84	6.94				
Critical Hdwy Stg 1	-	-	-	-	-	5.84				
Critical Hdwy Stg 2	-	-	-	-	-	5.84				
Follow-up Hdwy	-	-	2.22	-	3.52	3.32				
Pl Cap-1 Maneuver	-	-	724	-	125	539				
Stage 1	-	-	-	-	340	-				
Stage 2	-	-	-	-	583	-				
Platoon blocked, %	-	-	-	-	-	-				
Mov Cap-1 Maneuver	-	-	724	-	125	539				
Mov Cap-2 Maneuver	-	-	-	-	247	-				
Stage 1	-	-	-	-	339	-				
Stage 2	-	-	-	-	583	-				
Approach	EB	WB	NB							
HCM Control Delay, s	0	0	14.4							
HCM LOS	B									
Minor Lane/Major Mvmt	NBLn1	EBT	EBR	WBL	WBT					
Capacity (veh/h)	387	-	-	724	-					
HCM Lane V/C Ratio	0.009	-	-	0.003	-					
HCM Control Delay (s)	14.4	-	-	10	-					
HCM Lane LOS	B	-	-	A	-					
HCM 95th %ile Q(veh)	0	-	-	0	-					

Smoke Tree Resort
Existing PM

5: Lincoln Medical West & Lincoln Dr
HCM 6th TWSC

Intersection	0									
Int Delay, s/veh	0									
Movement	EBT	EBR	WBL	WBT	NBL	NBR				
Lane Configurations	↕	↕	↕	↕	↕	↕				
Traffic Vol, veh/h	849	0	0	870	2	0				
Future Vol, veh/h	849	0	0	870	2	0				
Conflicting Peds, #/hr	0	0	0	0	0	0				
Sign Control	Free	Free	Free	Free	Stop	Stop				
RT Channelized	-	None	-	None	-	None				
Storage Length	-	-	25	-	-	0				
Veh in Median Storage, #	0	-	-	0	0	-				
Grade, %	0	-	-	0	0	-				
Peak Hour Factor	90	90	90	90	90	90				
Heavy Vehicles, %	2	2	2	2	2	2				
Mvmt Flow	943	0	0	967	2	0				
Major/Minor	Major1	Major2	Minor1							
Conflicting Flow All	0	0	943	0	1427	472				
Stage 1	-	-	943	-	-	484				
Stage 2	-	-	-	-	-	-				
Critical Hdwy	-	-	4.14	-	6.84	6.94				
Critical Hdwy Stg 1	-	-	-	-	-	5.84				
Critical Hdwy Stg 2	-	-	-	-	-	5.84				
Follow-up Hdwy	-	-	2.22	-	3.52	3.32				
Pl Cap-1 Maneuver	-	-	723	-	126	538				
Stage 1	-	-	-	-	339	-				
Stage 2	-	-	-	-	585	-				
Platoon blocked, %	-	-	-	-	-	-				
Mov Cap-1 Maneuver	-	-	723	-	126	538				
Mov Cap-2 Maneuver	-	-	-	-	248	-				
Stage 1	-	-	-	-	339	-				
Stage 2	-	-	-	-	585	-				
Approach	EB	WB	NB							
HCM Control Delay, s	0	0	19.6							
HCM LOS	C									
Minor Lane/Major Mvmt	NBLn1	EBT	EBR	WBL	WBT					
Capacity (veh/h)	248	-	-	723	-					
HCM Lane V/C Ratio	0.009	-	-	0	-					
HCM Control Delay (s)	19.6	-	-	0	-					
HCM Lane LOS	C	-	-	A	-					
HCM 95th %ile Q(veh)	0	-	-	0	-					

Smoke Tree Resort
Existing PM

6: Lincoln Medical East & Lincoln Dr
HCM 6th TWSC

Intersection	7.6											
Int Delay, s/veh	0											
Movement	EBL	EBT	EBR	WBL	WBT	WBR	NBL	NBT	NBR	SBL	SBT	SBR
Lane Configurations	↖	↖	↖	↖	↖	↖	↖	↖	↖	↖	↖	↖
Traffic Vol, veh/h	849	0	0	869	2	3						
Future Vol, veh/h	849	0	0	869	2	3						
Conflicting Peds, #/hr	0	0	0	0	0	0						
Sign Control	Free	Free	Free	Free	Free	Free	Stop	Stop	Stop	Stop	Stop	Stop
RT Channelized	-	None	-	None	-	None	-	None	-	None	-	None
Storage Length	-	-	25	-	-	-	0	-	-	-	-	0
Veh in Median Storage, #	0	-	-	0	0	-	-	-	-	-	-	-
Grade, %	0	-	-	-	-	-	0	-	-	-	-	0
Peak Hour Factor	90	90	90	90	90	90	90	90	90	90	90	90
Heavy Vehicles, %	2	2	2	2	2	2	2	2	2	2	2	2
Mvmt Flow	943	0	0	966	2	3						
Major/Minor	Major1	Major2	Minor1									
Conflicting Flow All	0	0	943	0	1426	472						
Stage 1	-	-	-	943	-	-						
Stage 2	-	-	-	-	483	-						
Critical Hdwy	-	-	-	4.14	-	6.84	6.94					
Critical Hdwy Stg 1	-	-	-	-	-	5.84	-					
Critical Hdwy Stg 2	-	-	-	-	-	5.84	-					
Follow-up Hdwy	-	-	-	2.22	-	3.52	3.32					
Pot Cap-1 Maneuver	-	-	-	723	-	126	538					
Stage 1	-	-	-	-	-	339	-					
Stage 2	-	-	-	-	-	586	-					
Platoon blocked, %	-	-	-	-	-	-	-					
Mov Cap-1 Maneuver	-	-	-	723	-	126	538					
Mov Cap-2 Maneuver	-	-	-	-	-	248	-					
Stage 1	-	-	-	-	-	339	-					
Stage 2	-	-	-	-	-	586	-					
Approach	EB	WB	NB									
HCM Control Delay, s	0	0	15									
HCM LOS	C											
Minor Lane/Major Mvmt	NBLn1	EBT	EBR	WBL	WBT							
Capacity (veh/h)	367	-	-	723	-							
HCM Lane V/C Ratio	0.015	-	-	-	-							
HCM Control Delay (s)	15	-	-	0	-							
HCM Lane LOS	C	-	-	A	-							
HCM 95th %ile Q(veh)	0	-	-	0	-							

Smoke Tree Resort
Existing PM

7: Apartment Drwy & Lincoln Dr
HCM 6th TWSC

Intersection	7.6											
Int Delay, s/veh	7.6											
Movement	EBL	EBT	EBR	WBL	WBT	WBR	NBL	NBT	NBR	SBL	SBT	SBR
Lane Configurations	↖	↖	↖	↖	↖	↖	↖	↖	↖	↖	↖	↖
Traffic Vol, veh/h	792	41	6	777	9	66	3	47	7	0	34	
Future Vol, veh/h	792	41	6	777	9	66	3	47	7	0	34	
Conflicting Peds, #/hr	0	0	0	0	0	0	0	0	0	0	0	0
Sign Control	Free	Free	Free	Free	Free	Free	Stop	Stop	Stop	Stop	Stop	Stop
RT Channelized	-	None	-	None	-	None	-	None	-	None	-	None
Storage Length	25	-	-	25	-	-	-	-	-	0	-	0
Veh in Median Storage, #	0	-	-	0	-	-	0	-	-	0	-	0
Grade, %	0	-	-	-	-	-	0	-	-	-	-	0
Peak Hour Factor	90	90	90	90	90	90	90	90	90	90	90	90
Heavy Vehicles, %	2	2	2	2	2	2	2	2	2	2	2	2
Mvmt Flow	880	46	7	863	10	73	3	52	8	0	38	
Major/Minor	Major1	Major2	Minor1									
Conflicting Flow All	873	0	0	926	0	1365	1806	463	1340	-	437	
Stage 1	-	-	-	-	-	919	919	-	882	-	-	
Stage 2	-	-	-	-	-	446	887	-	458	-	-	
Critical Hdwy	4.14	-	-	4.14	-	7.54	6.54	6.94	7.54	-	6.94	
Critical Hdwy Stg 1	-	-	-	-	-	6.54	5.54	-	6.54	-	-	
Critical Hdwy Stg 2	-	-	-	-	-	6.54	5.54	-	6.54	-	-	
Follow-up Hdwy	2.22	-	-	2.22	-	3.52	4.02	3.32	3.52	-	3.32	
Pot Cap-1 Maneuver	768	-	-	734	-	106	78	546	111	0	567	
Stage 1	-	-	-	-	-	292	348	-	307	0	-	
Stage 2	-	-	-	-	-	561	360	-	552	0	-	
Platoon blocked, %	-	-	-	-	-	-	-	-	-	-	-	
Mov Cap-1 Maneuver	768	-	-	734	-	97	76	546	96	-	567	
Mov Cap-2 Maneuver	-	-	-	-	-	97	76	-	96	-	-	
Stage 1	-	-	-	-	-	289	345	-	304	-	-	
Stage 2	-	-	-	-	-	519	356	-	489	-	-	
Approach	EB	WB	NB									
HCM Control Delay, s	0.1	0.1	109.5									
HCM LOS	F											
Minor Lane/Major Mvmt	NBLn1	EBL	EBT	EBR	WBL	WBT	WBR	SBLn1	SBLn2			
Capacity (veh/h)	144	768	-	-	734	-	-	96	567			
HCM Lane V/C Ratio	0.895	0.01	-	-	0.009	-	-	0.081	0.067			
HCM Control Delay (s)	109.5	9.7	-	-	10	-	-	45.8	11.8			
HCM Lane LOS	F	A	-	-	A	-	-	E	B			
HCM 95th %ile Q(veh)	6.1	0	-	-	0	-	-	0.3	0.2			

Smoke Tree Resort
Existing PM

8: AJ's Drwy & Lincoln Dr
HCM 6th TWSC

Intersection	2.1													
Initial Delay, s/veh	EBL	EBT	EBR	WBL	WBT	WBR	NBL	NBT	NBR	SBL	SBT	SBR		
Lane Configurations	EBL	EBT	EBR	WBL	WBT	WBR	NBL	NBT	NBR	SBL	SBT	SBR		
Traffic Volume (vph)	11	786	53	61	775	8	14	1	89	4	0	7		
Future Volume (vph)	11	786	53	61	775	8	14	1	89	4	0	7		
Conflicting Peds, #/hr	0	0	0	0	0	0	0	0	0	0	0	0		
Sign Control	Free Free Free Free Free Free Free Free Free Free Free Free Free Free												Stop	Stop
RT Channelized	-												-	-
Storage Length	25												-	-
Veh in Median Storage, #	-												-	-
Grade, %	-												-	-
Peak Hour Factor	90	90	90	90	90	90	90	90	90	90	90	90		
Heavy Vehicles, %	2	2	2	2	2	2	2	2	2	2	2	2		
Mgmt Flow	12	873	59	68	861	9	16	1	99	4	0	8		
Major/Minor	Major1	Major2						Minor1		Minor2				
Conflicting Flow All	870	0	0	932	0	0	1494	1933	466	1463	-	435		
Stage 1	-	-	-	-	-	-	927	927	-	1002	-	-		
Stage 2	-	-	-	-	-	-	567	1006	-	461	-	-		
Critical Hdwy	4.14	-	-	4.14	-	-	7.54	6.54	6.94	7.54	-	6.94		
Critical Hdwy Stg 1	-	-	-	-	-	-	6.54	5.54	-	6.54	-	-		
Critical Hdwy Stg 2	-	-	-	-	-	-	6.54	5.54	-	6.54	-	-		
Follow-up Hdwy	2.22	-	-	2.22	-	-	3.52	4.02	3.32	3.52	-	3.32		
Pot Cap-1 Maneuver	770	-	-	730	-	-	85	66	543	90	0	569		
Stage 1	-	-	-	-	-	-	289	345	-	260	0	-		
Stage 2	-	-	-	-	-	-	476	317	-	550	0	-		
Platoon blocked, %	-	-	-	-	-	-	-	-	-	-	-	-		
Mov Cap-1 Maneuver	770	-	-	730	-	-	77	58	543	67	-	569		
Mov Cap-2 Maneuver	-	-	-	-	-	-	284	339	-	256	-	-		
Stage 1	-	-	-	-	-	-	426	288	-	441	-	-		
Stage 2	-	-	-	-	-	-	-	-	-	-	-	-		
Approach	EB	WB	NB	WB	NB	SB								
HCM Control Delay, s	0.1	0.8	0.8											
HCM LOS	D	D	D											
Minor Lane/Major Mvmt	NBLn1	EBL	EBT	EBR	WBL	WBT	WBR	SBLn1	SBLn2	SBLn2				
Capacity (veh/h)	287	770	-	-	730	-	-	67	569					
HCM Lane V/C Ratio	0.403	0.016	-	-	0.093	-	-	0.066	0.014					
HCM Control Delay (s)	25.7	9.8	-	-	10.4	-	-	62.5	11.4					
HCM Lane LOS	D	A	-	-	B	-	-	F	B					
HCM 95th %ile Q(veh)	1.9	0	-	-	0.3	-	-	0.2	0					

Smoke Tree Resort
Existing PM

9: Scottsdale Rd & Lincoln Dr
Timings

	EBL	EBT	EBR	WBL	WBT	WBR	NBL	NBT	NBR	SBL	SBT	SBR
Lane Group	EBL	EBT	EBR	WBL	WBT	WBR	NBL	NBT	NBR	SBL	SBT	SBR
Lane Configurations	EBL	EBT	EBR	WBL	WBT	WBR	NBL	NBT	NBR	SBL	SBT	SBR
Traffic Volume (vph)	461	54	385	54	60	373	1514	56	1461	449	449	
Future Volume (vph)	461	54	385	54	60	373	1514	56	1461	449	449	
Turn Type	Split	NA	pm+ov	Split	NA	pm+ov	Prot	NA	Prot	NA	pm+ov	
Protected Phases	4	4	5	8	8	5	2	1	6	4		
Permitted Phases	4	4	5	8	8	5	2	1	6	4		
Detector Phase	4	4	5	8	8	5	2	1	6	4		
Switch Phase	4	4	5	8	8	5	2	1	6	4		
Minimum Initial (s)	7.0	7.0	7.0	7.0	7.0	7.0	7.0	10.0	5.0	10.0	7.0	
Minimum Split (s)	13.0	13.0	13.0	13.0	13.0	13.0	16.7	11.0	16.0	13.0		
Total Split (s)	30.0	30.0	30.0	30.0	30.0	30.0	73.0	14.0	57.0	30.0		
Total Split (%)	23.1%	23.1%	23.1%	10.0%	10.0%	23.1%	56.2%	10.8%	43.8%	23.1%		
Yellow Time (s)	4.0	4.0	4.0	3.6	3.6	4.0	4.7	3.3	4.7	4.0		
All-Red Time (s)	1.5	1.5	1.5	2.0	2.0	1.5	1.0	2.0	1.0	1.5		
Lost Time Adjust (s)	0.0	0.0	0.0	0.0	0.0	0.0	0.0	0.0	0.0	0.0		
Total Lost Time (s)	5.5	5.5	5.5	5.6	5.6	5.5	5.7	5.3	5.7	5.5		
Lead/Lag	Lead											
Lead-Lag Optimize?	None											
Recall Mode	None											
Act Effct Green (s)	23.9	23.9	43.7	7.3	7.3	19.9	71.1	7.7	56.6	86.2		
Actuated g/C Ratio	0.18	0.18	0.34	0.06	0.06	0.15	0.55	0.06	0.44	0.66		
v/C Ratio	0.93	0.91	0.74	0.61	0.86	0.79	0.62	0.60	0.73	0.46		
Control Delay	88.8	85.1	29.5	84.9	38.1	64.2	22.3	82.1	33.6	9.9		
Queue Delay	0.0	0.0	0.0	0.0	0.0	0.0	0.0	0.0	0.0	0.0		
Total Delay	88.8	85.1	29.5	84.9	38.1	64.2	22.3	82.1	33.6	9.9		
LOS	F	F	C	F	D	E	C	F	C	A		
Approach Delay	62.4											
Approach LOS	E											
Intersection Summary	Intersection LOS: D											
Cycle Length: 130	Natural Cycle: 90											
Actuated Cycle Length: 130	Control Type: Actuated-Coordinated											
Offset: 0 (0%), Referenced to phase 6.SBT, Start of Green	Maximum v/C Ratio: 0.93											
Intersection Signal Delay: 36.6	Intersection LOS: D											
Intersection Capacity Utilization 71.5%	ICU Level of Service D											
Analysis Period (min) 15												

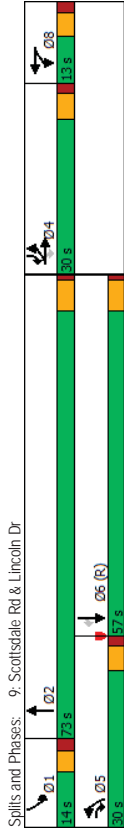

Smoke Tree Resort
Existing PM

9: Scottsdale Rd & Lincoln Dr
HCM 6th Signalized Intersection Summary

Movement	EBL	EBT	EBR	WBL	WBT	WBR	NBL	NBT	NBR	SBL	SBT	SBR
Lane Configurations	↔	↔	↔	↔	↔	↔	↔	↔	↔	↔	↔	↔
Traffic Volume (veh/h)	461	54	385	54	60	67	373	1514	44	56	1461	449
Future Volume (veh/h)	461	54	385	54	60	67	373	1514	44	56	1461	449
Initial Q (Q _{bb}), veh	0	0	0	0	0	0	0	0	0	0	0	0
Ped-Bike Adj(A_pb1)	1.00	1.00	1.00	1.00	1.00	1.00	1.00	1.00	1.00	1.00	1.00	1.00
Parking Bus, Adj	1.00	1.00	1.00	1.00	1.00	1.00	1.00	1.00	1.00	1.00	1.00	1.00
Work Zone On Approach	No	No	No	No	No	No	No	No	No	No	No	No
Adj Sat Flow, veh/h	1870	1870	1870	1870	1870	1870	1870	1870	1870	1870	1870	1870
Adj Flow Rate, veh/h	555	0	428	60	67	74	414	1682	49	62	1623	499
Peak Hour Factor	0.90	0.90	0.90	0.90	0.90	0.90	0.90	0.90	0.90	0.90	0.90	0.90
Percent Heavy Veh, %	2	2	2	2	2	2	2	2	2	2	2	2
Cap, veh/h	671	0	516	101	101	90	473	2491	73	79	2015	924
Arrive On Green	0.19	0.00	0.19	0.06	0.06	0.06	0.14	0.49	0.49	0.04	0.39	0.39
Sat Flow, veh/h	3563	0	1585	1781	1777	1585	3456	5099	149	1781	5106	1585
Grp Volume(v), veh/h	555	0	428	60	67	74	414	1123	608	62	1623	499
Grp Sat Flow(s), veh/h	1781	0	1585	1781	1777	1585	1728	1702	1844	1781	1702	1585
Q Serve(g_s), s	19.5	0.0	24.5	4.3	4.8	6.0	15.3	32.7	32.7	4.5	36.7	24.9
Cycle O Clear(g_c), s	19.5	0.0	24.5	4.3	4.8	6.0	15.3	32.7	32.7	4.5	36.7	24.9
Prop In Lane	1.00	1.00	1.00	1.00	1.00	1.00	1.00	1.00	1.00	1.00	1.00	1.00
Lane Grp Cap(c), veh/h	671	0	516	101	101	90	473	1663	901	79	2015	924
V/C Ratio(x)	0.83	0.00	0.83	0.59	0.66	0.82	0.87	0.68	0.68	0.78	0.81	0.54
Avail Cap(c_a), veh/h	671	0	516	101	101	90	651	1762	954	119	2015	924
HCM Platoon Ratio	1.00	1.00	1.00	1.00	1.00	1.00	1.00	1.00	1.00	1.00	1.00	1.00
Upstream Filter(i)	1.00	0.00	1.00	1.00	1.00	1.00	1.00	1.00	1.00	1.00	1.00	1.00
Uniform Delay (d), s/veh	50.7	0.0	40.5	59.8	60.1	60.6	55.0	25.4	25.4	61.5	34.9	16.5
Incr Delay (d2), s/veh	7.9	0.0	70.3	6.2	12.2	40.6	7.7	0.7	1.4	8.7	3.6	2.3
Initial Q Delay(Q3), s/veh	0.0	0.0	0.0	0.0	0.0	0.0	0.0	0.0	0.0	0.0	0.0	0.0
%ile BackOfQ(50%), veh/h	9.4	0.0	14.1	2.1	2.5	3.4	7.2	13.2	14.5	2.2	15.7	14.4
Unsig. Movement Delay, s/veh	58.6	0.0	50.8	66.0	72.3	101.2	62.7	26.1	26.7	70.2	38.5	18.8
LnGrp Delay(d), s/veh	E	A	D	E	E	F	E	C	C	E	D	B
LnGrp LOS	E	A	D	E	E	F	E	C	C	E	D	B
Approach Vol, veh/h	983			201			2145				2184	
Approach Delay, s/veh	55.2			81.1			33.4				34.9	
Approach LOS	E			F			C				C	
Timer - Assigned Phs	1	2	2	4	5	6	8					
Phs Duration (G+Y+Rc), s	11.1	69.2		30.0	23.3	57.0	13.0					
Change Period (Y+Rc), s	* 5.3	5.7		5.5	5.5	5.7	5.6					
Max Green Setting (Gmax), s	* 8.7	67.3		24.5	24.5	51.3	7.4					
Max Q Clear Time (g_c+1t), s	6.5	34.7		26.5	17.3	38.7	8.0					
Green Ext Time (g_e), s	0.0	2.7		0.0	0.5	2.6	0.0					
Intersection Summary												
HCM 6th Ctrl Delay	39.6											
HCM 6th LOS	D											
Notes												
User approved pedestrian interval to be less than phase max green.												
User approved volume balancing among the lanes for turning movement.												
* HCM 6th computational engine requires equal clearance times for the phases crossing the barrier.												

APPENDIX D

TRIP GENERATION

Smoke Tree Resort

Proposed

Trip Generation

November 2018

Appendix D

Methodology Overview

This form facilitates trip generation estimation using data within the Institute of Transportation Engineer's (ITE) *Trip Generation Manual*, 10th Edition and methodology described within ITE's *Trip Generation Handbook*, 3rd Edition. These references will be referred to as *Manual and Handbook*, respectively. The *Manual* contains data collected by various transportation professionals for a wide range of different land uses, with each land use category represented by a land use code (LUC). Average rates and equations have been established that correlate the relationship between an independent variable that describes the development size and generated trips for each categorized LUC in various settings and time periods. The *Handbook* indicates an established methodology for how to use data contained within the Manual when to use the fitted curve instead of the average rate and when to adjustments to the volume of trips are appropriate and how to do so. The methodology steps are represented visually in boxes in Figure 3.1. This worksheet applies calculations for each box if applicable.

Box 1 - Define Study Site Land Use Type & Site Characteristics

The analyst is to pick an appropriate LUC(s) based on the subject's zoning/land use(s)/future land use(s). The size of the land use(s) is described in reference to an independent variable(s) specific to (each) the land use (example: 1,000 square feet of building area is relatively common).

Land Use Types and Size

Proposed Use	Amount Units	ITE LUC	ITE Land Use Name
Resort Hotel	150 Rooms	330	Resort Hotel
Condos	30 Dwelling Units	220	Multifamily Housing (Low-Rise)
Quality Restaurant	3.500 1,000 square feet	931	Quality Restaurant

Box 2 - Define Site Context

Context assessment is to "simply determine whether the study sites is in a multimodal setting" and "could have persons accessing the site by walking, bicycling, or riding transit." This assessment is used in Box 4. The *Manual* separates data into 4 setting categories - **Rural**, **General Urban/Suburban**, **Dense Multi-Urban Use** and **Center City Core**. This worksheet uses the following abbreviations, respectively: **R**, **G**, **D**, and **C**. The *Manual* does not have data for all settings of all land use codes. See the table on the next page titled "Site Context and Time Periods" - if this table is not provided, the "General Urban/Suburban" setting is used by default.

Box 3 - Define Analysis Objectives Types of Trips & Time Period

This tool will focus on vehicular trips for a 24-hour period on a typical weekday as well as its AM peak hour and PM peak hour. Other time period(s) may be of interest.

Smoke Tree Resort

Proposed

Trip Generation

November 2018

Appendix D

Box 4 - Is Study Site Multimodal?

Per the Handbook, "if the objective is to establish a local trip generation rate for a particular land use or study site, the simplified approach (Box 9) may be acceptable but the *Box 5 through 8* approach is required if the study site is located in an infill setting, contains a mix of uses on-site, or is near significant transit service."

Box 5/Box 9 - Estimate Baseline Trips/Estimate Vehicular Trips (Determine Equation)

Vehicle trips are estimated using rates/equations applicable to each LUC. When the appropriate graph has a fitted curve, the *Handbook* has a process (Figure 4.2) to determine when to use it versus using the weighted average rate or collecting local data. The methodology requires for engineering judgement in some circumstances and permits engineering judgement to override or make adjustments when appropriate to best project (example 1: study site is expected to operate differently than data in the applicable land use code - such as restaurant that is closed in the morning or in the evening; example 2: LUC data in a localized area fails to be represented by the typically selected fitted curve/weighted average rate - a small shop/LUC 820, AM peak hour is skewed by the high y-intercept).

Equation Type: Equation Used [Equated Rate] (Type Abbreviations: Weighted Average Rate ("WA"), Fitted Curve ("FC"), or Custom ("C"))

Proposed Use	ADT	AM Peak Hour	PM Peak Hour	(not used)
Resort Hotel	WA: []	FC: $T=0.38 \cdot X - 28.58$ [0.19]	FC: $T=0.52 \cdot X - 55.42$ [0.15]	
Condos	FC: $T=7.56 \cdot X - 40.86$ [6.20]	FC: $\text{LN}(T)=0.95 \cdot \text{LN}(X) - 0.51$ [0.51]	FC: $\text{LN}(T)=0.89 \cdot \text{LN}(X) - 0.02$ [0.67]	
Quality Restaurant	WA: $T=X \cdot 83.84$ [83.84]	WA: $T=X \cdot 0.73$ [0.73]	WA: $T=X \cdot 7.8$ [7.80]	

Box 5/Box 9 - Estimate Baseline Trips/Estimate Vehicular Trips (Apply Equations and in/out Distributions)

Baseline Vehicular Trips

Proposed Use	ADT				AM Peak Hour				PM Peak Hour				(not used)
	% In	In	Out	Total	% In	In	Out	Total	% In	In	Out	Total	
Resort Hotel	50%	389	389	778	72%	42	17	59	43%	32	43	75	
Condos	50%	93	93	186	23%	3	12	15	63%	13	7	20	
Quality Restaurant	50%	147	147	294	0%	0	3	3	67%	18	9	27	
Totals		629	629	1,258		45	32	77		63	59	122	



Box 6 - Convert Baseline Vehicle Trips to Person Trips

If no vehicle trip reductions are to be applied, this portion may be ignored. The *Handbook* states "There are not enough samples to derive precise percentages by mode...however, for all but one, ...the motor vehicle percentage of total person trips is at least 96 percent." and "[vehicle occupancy for] many of the most commonly analyzed land use codes are not [available]." This form assumes that the total baseline vehicle trips for all land use codes accounts for 90% of total person trips. Unless otherwise specified, this form later reverses the conversion in Box 8.

Box 7 - Estimate Internal Person Trips, External Walk/Bike Trips, Transit Person Trips, External Person Trips (Internal Capture)

Internal capture occurs for mixed-use developments when a portion of the trips generated by the site are expected to have the both the origin and destination within the site. Internal capture is not dependent on mode choice. The table below presents the internal capture percentages and trips in units of vehicle trips. CivTech can provide trips in units of persons if requested.

Adjustments for Internal Trips

Proposed Use	ADT			AM Peak Hour				PM Peak Hour				(not used)	
	Percent	In	Out	Total	Percent	In	Out	Total	Percent	In	Out		Total
Resort Hotel	0%	0	0	0	0%	0	0	0	0%	0	0	0	
Condos	0%	0	0	0	0%	0	0	0	0%	0	0	0	
Quality Restaurant	50%	74	74	148	50%	0	2	2	50%	9	5	14	
Totals		74	74	148		0	2	2		9	5	14	

Box 8 - Convert Person Trips to Final Vehicle Trips

The vehicle occupancy and baseline alternate mode are now factored out from the external trips in vehicles, after any adjustments for internal capture and additional alternate mode from Box 7. In Box 6, vehicle trips were considered to account for 90% of total person trips. Alternate mode trips in addition to the baseline, if any, are accounted for in Box 7. It is estimated that vehicle trips should be reduced by an additional 0% due to carpooling. The final external trips in vehicles is multiplied by $90\% - 0\% = 90\%$ to produce the external vehicle trips.

External Vehicular Trips

Proposed Use	ADT			AM Peak Hour			PM Peak Hour			(not used)
	In	Out	Total	In	Out	Total	In	Out	Total	
Totals	555	555	1,110	45	30	75	54	54	108	

Box 10 - Estimate Vehicle Trip Subsets Pass-by/Diverted Trips, Truck Trips (Pass-By Trips)

Some trips may be classified as "pass-by" trips, where some vehicle trips generated by the study site are already traveling on an adjacent road and make a stop while passing by. These trips do not add traffic volume to the roadway. The *Handbook* does not specify that a 'pair' of pass-by trips must enter and exit the same driveway. The current edition of the *Handbook* indicates that pass-by trips should have directional distribution applied (%in/%out), though reviewers often comment when pass-by trip "pairs" do not occur within a the specified time period. This is likely due to ease of calculation and traditional methodology found in the first edition of the *Handbook*. As such, the analyst may ignore the direction distribution divide the total pass-by trip volume by 2 to apply pass-by "pairs". In addition, the analyst may consider pass-by rates at a reduced rate. Data is not available for all land use codes and all periods, assumptions are highlighted. The percentage is applied to total external vehicle trips.

APPENDIX E

TRIP DISTRIBUTION

Quadrant	2020		2030	
	Population	Percent	Population	Percent
North Northwest	65,355	13.6%	70,346	13.6%
North Northeast	46,994	9.8%	50,587	9.8%
North	112,348	23.4%	120,934	23.4%
East Northeast	49,891	10.4%	52,124	10.1%
East Southeast	14,233	3.0%	14,712	2.8%
East	64,123	13.4%	66,836	12.9%
South Southeast	81,730	17.0%	92,480	17.8%
South Southwest	92,361	19.2%	99,928	19.3%
South	174,091	36.2%	192,407	37.1%
West Southwest	69,372	14.4%	74,834	14.4%
West Northwest	60,317	12.6%	63,387	12.2%
West	129,689	27.0%	138,221	26.6%
Totals	480,252	100.0%	518,398	100.0%

Radius

Population radius: 10 miles

Select Analysis Year (2020, 2030, 2040,2050)

2020

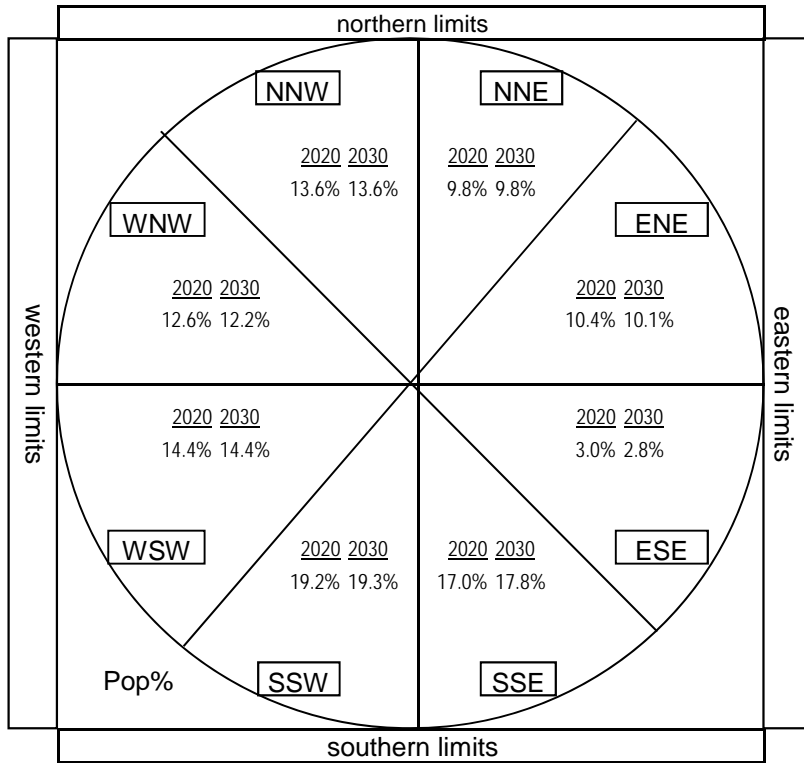

10-mile radius

		2020	2030	% of	2020	2030			2020	2030	% of	2020	2030	
RAZ	MPA	Population	Population	TAZ	Adjusted	Adjusted	RAZ	MPA	Population	Population	TAZ	Adjusted	Adjusted	
NNW							NNE							
245	PH	57,570	59,845	30%	17,271	17,954	228	PH	17,962	39,116	5%	898	1,956	
227	PH	56,483	67,265	5%	2,824	3,363	230	SC	33,607	41,394	15%	5,041	6,209	
228	PH	17,962	39,116	10%	1,796	3,912	246	PH	60,062	62,330	25%	15,016	15,583	
246	PH	60,062	62,330	70%	42,043	43,631	247	SC	13,321	13,647	100%	13,321	13,647	
262	PV	14,198	14,871	10%	1,420	1,487	248	SC	37,661	39,019	30%	11,298	11,706	
		-	-		-	-	262	PV	14,198	14,871	10%	1,420	1,487	
		-	-		-	-			-	-		-	-	
		-	-		-	-			-	-		-	-	
		-	-		-	-			-	-		-	-	
		-	-		-	-			-	-		-	-	
		-	-		-	-			-	-		-	-	
		-	-		-	-			-	-		-	-	
		-	-		-	-			-	-		-	-	
		-	-		-	-			-	-		-	-	
		-	-		-	-			-	-		-	-	
		-	-		-	-			-	-		-	-	
		-	-		-	-			-	-		-	-	
		-	-		-	-			-	-		-	-	
		-	-		-	-			-	-		-	-	
		-	-		-	-			-	-		-	-	
		-	-		-	-			-	-		-	-	
		-	-		-	-			-	-		-	-	
		-	-		-	-			-	-		-	-	
		-	-		-	-			-	-		-	-	
From NNW					65,355	70,346	From NNE					46,994	50,587	
From North													112,348	120,934



10-mile radius

		2020	2030	% of	2020	2030			2020	2030	% of	2020	2030
RAZ	MPA	Population	Population	TAZ	Adjusted	Adjusted	RAZ	MPA	Population	Population	TAZ	Adjusted	Adjusted
SSE							SSW						
262	PV	14,198	14,871	10%	1,420	1,487	262	PV	14,198	14,871	20%	2,840	2,974
263	SC	36,704	37,882	20%	7,341	7,576	271	PH	67,978	72,784	55%	37,388	40,031
272	SC	72,339	81,764	95%	68,722	77,676	272	SC	72,339	81,764	5%	3,617	4,088
264	SR	6,766	7,102	5%	338	355	276	PH	48,517	52,834	100%	48,517	52,834
288	TE	78,175	107,704	5%	3,909	5,385			-	-		-	-
From SSE					81,730	92,480	From SSW					92,361	99,928
From South												174,091	192,407

APPENDIX F

BACKGROUND TRAFFIC

Location of counts: Scottsdale Road between Indian Bend and Lincoln

Source(s): <https://www.scottsdaleaz.gov/transportation/studies-reports/traffic-volume>

	Year	Volume	Avg Growth Rate to 2012	Expansion Factor to 2012
Beginning	2012	43,500		
End	2014	45,000	1.7%	0.967

Growth Rate Used 1.7%
 Per-Year Multiplier 1.017

Year	Expansion Factor(s)
2018	1.000
2019	1.017
2020	1.034 <- Expansion factor to opening
2021	1.052
2022	1.070
2023	1.088
2024	1.106
2025	1.125 <- Expansion factor to 5 years after opening
2026	1.144
2027	1.164
2028	1.184
2029	1.204
2030	1.224
2031	1.245
2032	1.266
2033	1.288
2034	1.310
2035	1.332
2036	1.354
2037	1.378
2038	1.401

Lincoln medical site

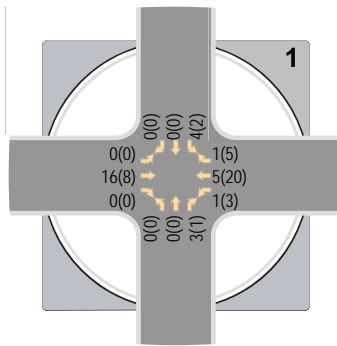

Mockingbird Lane & Lincoln Dr

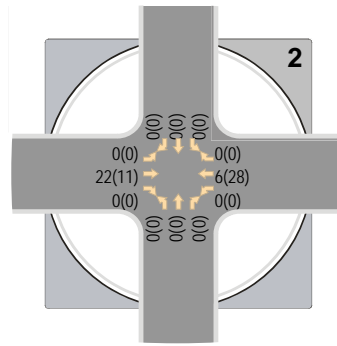

Quail Run Rd & Lincoln Dr

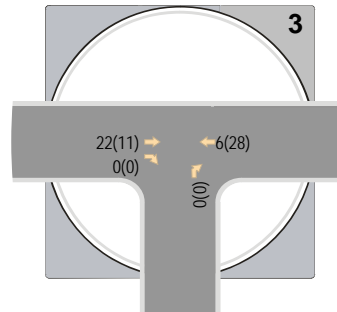

Smoke Tree Drwy West & Lincoln Dr

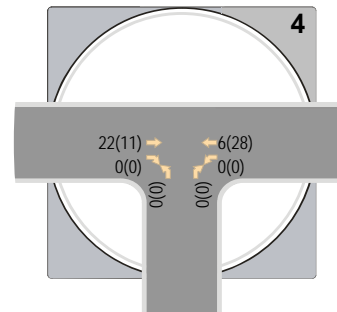

Smoke Tree Drwy East & Lincoln Dr

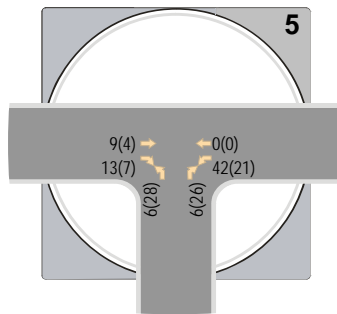

Medical Drwy West & Lincoln Dr

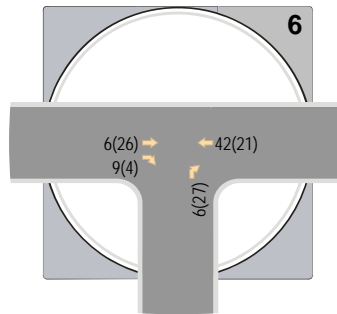

Medical Drwy East & Lincoln Dr

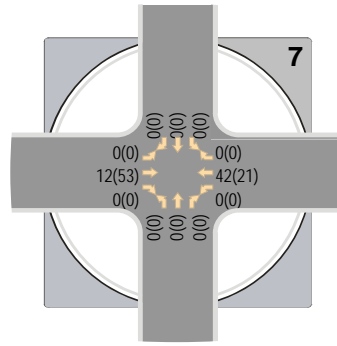

Apartment Drwy & Lincoln Dr

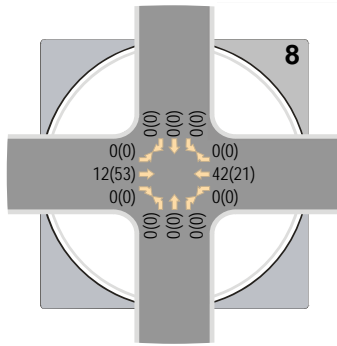

AJ's Drwy & Lincoln Dr

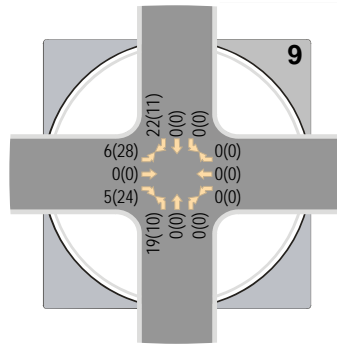

Scottsdale Rd & Lincoln Dr

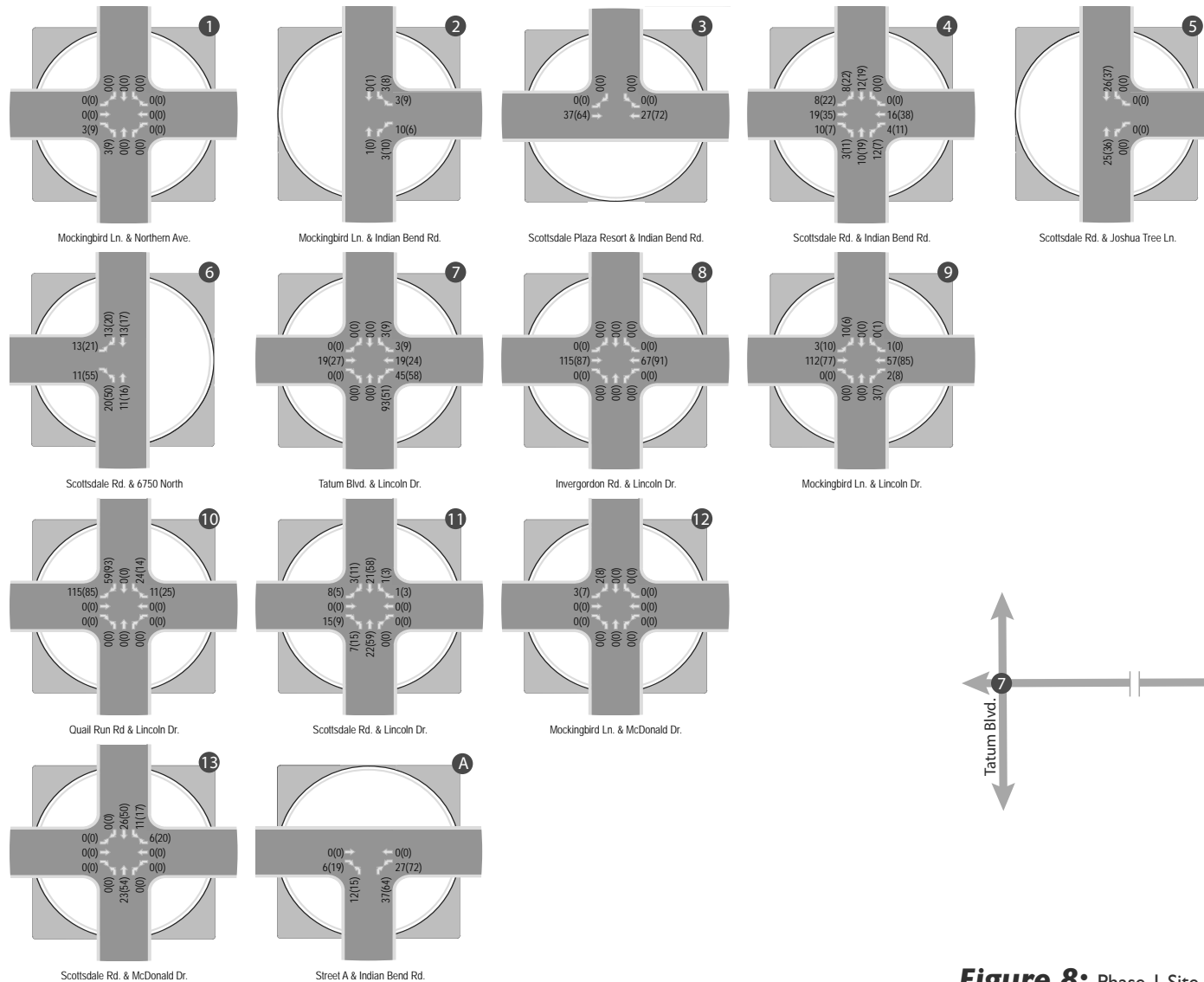

LEGEND
 XX(XX) - AM(PM) Peak Hour Traffic Volumes

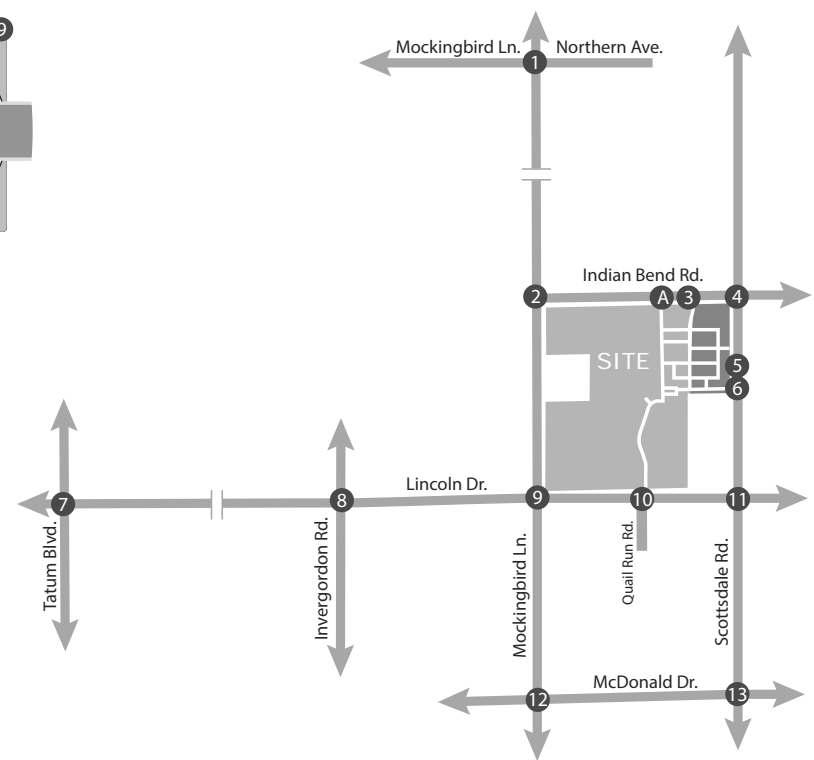

Figure 8: Phase I Site Generated Traffic Volumes without Palmeraie Access A

APPENDIX G

2020 PEAK HOUR ANALYSIS

Smoke Tree Resort
2020 Background AM

1: Mockingbird Ln & Lincoln Drive
Timings

	EBT	WBL	WBT	NBL	NBT	SBL	SBT
Lane Group	EBL	EBT	WBL	WBT	NBL	NBT	SBL
Lane Configurations	222	971	23	890	5	34	76
Traffic Volume (vph)	222	971	23	890	5	34	76
Future Volume (vph)	pm+pt	NA	Perm	NA	pm+pt	NA	NA
Turn Type	1	6	2	2	4	4	3
Protected Phases	6	2	2	4	4	3	8
Permitted Phases	1	6	2	2	4	4	3
Detector Phase	3.5	15.0	15.0	7.0	7.0	3.5	7.0
Switch Phase	8.0	27.0	27.0	33.5	33.5	8.0	33.5
Minimum Initial (s)	27.0	77.0	50.0	44.0	44.0	9.0	53.0
Minimum Split (s)	20.8%	59.2%	38.5%	38.8%	33.8%	6.9%	40.8%
Total Split (%)	3.0	4.5	4.5	4.0	4.0	3.0	4.0
Yellow Time (s)	1.0	1.5	1.5	2.5	2.5	1.0	2.5
All-Red Time (s)	0.0	0.0	0.0	0.0	0.0	0.0	0.0
Lost Time Adjust (s)	4.0	6.0	6.0	6.5	6.5	4.0	6.5
Total Lost Time (s)	Lead	Lag	Lag	Lag	Lag	Lag	Lead
Lead/Lag	Yes	Yes	Yes	Yes	Yes	Yes	Yes
Lead-Lag Optimize?	None	C-Max	C-Max	None	None	None	None
Recall Mode	93.3	91.3	70.1	17.4	17.4	28.7	26.2
Act Effct Green (s)	0.72	0.70	0.54	0.13	0.13	0.22	0.20
Actuated g/C Ratio	0.57	0.45	0.10	0.55	0.08	0.24	0.30
v/c Ratio	13.0	10.1	18.3	25.3	46.2	32.4	41.8
Queue Delay	0.0	0.0	0.0	0.0	0.0	0.0	0.0
Control Delay	13.0	10.1	18.3	25.3	46.2	32.4	41.8
Total Delay	B	B	B	C	D	C	D
LOS	10.6	25.1	33.7	48.6			
Approach Delay	B	B	B	B	B	B	B
Approach LOS	B	B	B	B	B	B	B
Intersection Summary							
Cycle Length: 130							
Actuated Cycle Length: 130							
Offset: 0 (0%), Referenced to phase 2:WBT and 6:EBT, Start of Green							
Natural Cycle: 90							
Control Type: Actuated-Coordinated							
Maximum v/c Ratio: 0.84							
Intersection Signal Delay: 22.1							
Intersection Capacity Utilization 74.7%							
Analysis Period (min) 15							

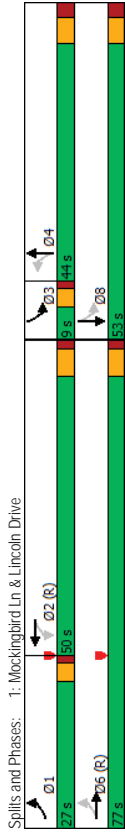

Smoke Tree Resort
2020 Background AM

1: Mockingbird Ln & Lincoln Drive
HCM 6th Signalized Intersection Summary

	EBL	EBT	EBR	WBL	WBT	WBR	NBL	NBT	NBR	SBL	SBT	SBR
Movement	EBL	EBT	EBR	WBL	WBT	WBR	NBL	NBT	NBR	SBL	SBT	SBR
Lane Configurations	222	971	30	23	890	42	5	34	22	76	88	233
Traffic Volume (veh/h)	222	971	30	23	890	42	5	34	22	76	88	233
Future Volume (veh/h)	0	0	0	0	0	0	0	0	0	0	0	0
Initial Q (Obs.) veh	1.00	1.00	1.00	1.00	1.00	1.00	1.00	1.00	1.00	1.00	1.00	1.00
Ped-Bike Adj(A_pbT)	No	No	No	No	No	No	No	No	No	No	No	No
Work Zone On Approach	1870	1870	1870	1870	1870	1870	1870	1870	1870	1870	1870	1870
Adj Sat Flow (veh/h)	247	1079	33	26	989	47	6	38	24	84	98	259
Adj Flow Rate	0.90	0.90	0.90	0.90	0.90	0.90	0.90	0.90	0.90	0.90	0.90	0.90
Peak Hour Factor	2	2	2	2	2	2	2	2	2	2	2	2
Percent Heavy Veh. %	397	2334	71	316	1919	91	88	184	116	313	109	289
Cap. veh/h	0.08	0.66	0.66	0.56	0.56	0.56	0.17	0.17	0.17	0.04	0.24	0.24
Arrive On Green	1781	3520	108	507	3454	164	1024	1072	677	1781	454	1200
Sat Flow (veh/h)	247	545	567	26	509	527	6	6	62	84	0	357
Grp Volume(v) veh/h	1781	1777	1851	507	1777	1841	1024	0	1749	1781	0	1654
Grp Sat Flow(s) veh/h	7.4	19.4	19.4	3.4	23.2	23.2	23.2	18.9	4.0	5.0	0.0	27.2
Q Serve(g.s) s	1.00	0.06	1.00	1.00	0.09	1.00	1.00	0.39	1.00	1.00	0.73	1.00
Prop In Lane	397	1178	1227	316	987	1023	88	0	300	313	0	398
V/C Ratio(x)	0.62	0.46	0.46	0.08	0.52	0.52	0.07	0.00	0.21	0.27	0.00	0.90
Lane Grp Cap(c) veh/h	576	1178	1227	316	987	1023	208	1.00	504	313	0	592
Avail Cap(c.a) veh/h	1.00	1.00	1.00	1.00	1.00	1.00	1.00	1.00	1.00	1.00	1.00	1.00
HCM Platoon Ratio	1.00	1.00	1.00	1.00	1.00	1.00	1.00	1.00	1.00	1.00	1.00	1.00
Upstream Filter(i)	13.8	10.6	10.6	16.2	18.0	18.0	61.3	0.0	46.2	41.1	0.0	47.8
Uniform Delay (d) s/veh	1.6	1.3	1.3	0.3	1.1	1.0	0.3	0.0	0.3	0.5	0.0	11.7
Incr Delay (d2) s/veh	0.0	0.0	0.0	0.0	0.0	0.0	0.0	0.0	0.0	0.0	0.0	0.0
Initial Q Delay(d3) s/veh	3.0	7.7	8.0	0.4	9.7	10.0	0.2	0.0	1.8	2.2	0.0	12.5
%ile BackQ(50%) veh/m	Unsig. Movement Delay, s/veh											
Unsig. Movement Delay, s/veh	15.4	12.0	11.9	16.5	19.1	19.0	61.6	0.0	46.6	41.5	0.0	59.5
LnGrp Delay(d) s/veh	B	B	B	B	B	B	B	E	A	D	D	A
LnGrp LOS	B	B	B	B	B	B	B	E	A	D	D	A
Approach Vol. veh/h	1359											
Approach Delay, s/veh	12.6											
Approach LOS	B											
Timer - Assigned Phs	1	2	3	4	6	8						
Phs Duration (G+Y+Rc) s	14.0	78.2	9.0	28.8	92.2	37.8						
Change Period (Y+Rc) s	4.0	6.0	4.0	6.5	6.0	6.5						
Max Green Setting (Gmax) s	23.0	44.0	5.0	37.5	71.0	46.5						
Max Q Clear Time (g_c+I1) s	9.4	25.2	7.0	20.9	21.4	29.2						
Green Ext Time (g_e) s	0.6	7.1	0.0	0.2	9.8	2.2						
Intersection Summary												
HCM 6th Ctrl Delay	22.3											
HCM 6th LOS	C											

Smoke Tree Resort
2020 Background AM

2: Quail Run Rd & Lincoln Drive
HCM 6th Signalized Intersection Summary

	EBL	EBT	WBL	WBT	NBT	SBL	SBT	
Lane Group	EBL	EBT	WBL	WBT	NBT	SBL	SBT	
Lane Configurations	115	1017	2	853	0	26	0	
Traffic Volume (vph)	115	1017	2	853	0	26	0	
Future Volume (vph)	pm-plt	NA	Perm	NA	NA	Perm	NA	
Turn Type	7	4	8	8	2	6	6	
Protected Phases	4	8	8	8	2	6	6	
Permitted Phases	7	4	8	8	2	6	6	
Detector Phase	3.5	15.0	15.0	15.0	7.0	7.0	7.0	
Switch Phase	8.0	28.0	28.0	28.0	33.0	33.0	33.0	
Minimum Initial (s)	20.0	94.0	74.0	74.0	36.0	36.0	36.0	
Minimum Split (s)	15.4%	72.3%	56.9%	56.9%	27.7%	27.7%	27.7%	
Total Split (%)	3.0	4.0	4.0	4.0	4.5	4.5	4.5	
Yellow Time (s)	1.0	2.5	2.5	2.5	1.5	1.5	1.5	
All-Red Time (s)	0.0	0.0	0.0	0.0	0.0	0.0	0.0	
Lost Time Adjust (s)	4.0	6.5	6.5	6.5	6.0	6.0	6.0	
Total Lost Time (s)	Lead	Lag	Lag	Lag				
Lead/Lag	Yes	Yes	Yes	Yes				
Lead-Lag Optimize?	None	None	None	None	C-Max	C-Max	C-Max	
Recall Mode	64.0	61.5	46.2	46.2	56.0	56.0	56.0	
Act Effct Green (s)	0.49	0.47	0.36	0.36	0.43	0.43	0.43	
Actuated g/C Ratio	0.53	0.68	0.02	0.76	0.01	0.05	0.09	
v/c Ratio	29.9	35.8	23.5	40.9	0.0	26.1	0.2	
Control Delay	0.0	0.0	0.0	0.0	0.0	0.0	0.0	
Queue Delay	29.9	35.8	23.5	40.9	0.0	26.1	0.2	
Total Delay	C	D	C	D	A	C	A	
LOS	35.2	D	D	D	40.8	7.6	A	
Approach Delay	Intersection Summary							
Approach LOS	Cycle Length: 130							
Actuated Cycle Length: 130	Offset: 0 (0%), Referenced to phase 2:NBT and 6:SBTL, Start of Green							
Offset: 0 (0%), Referenced to phase 2:NBT and 6:SBTL, Start of Green	Natural Cycle: 70							
Natural Cycle: 70	Control Type: Actuated-Coordinated							
Control Type: Actuated-Coordinated	Maximum v/c Ratio: 0.76							
Maximum v/c Ratio: 0.76	Intersection Signal Delay: 36.2							
Intersection Signal Delay: 36.2	Intersection Capacity Utilization 64.6%							
Intersection Capacity Utilization 64.6%	Analysis Period (min) 15							
Analysis Period (min) 15								

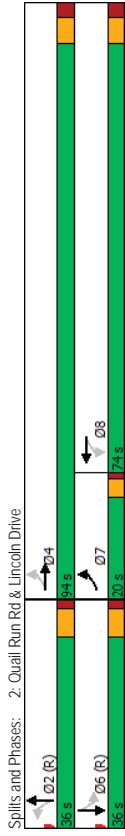

Smoke Tree Resort
2020 Background AM

2: Quail Run Rd & Lincoln Drive
HCM 6th Signalized Intersection Summary

	EBL	EBT	WBL	WBT	NBL	NBT	NBR	SBL	SBT	SBR
Movement	EBL	EBT	WBL	WBT	NBL	NBT	NBR	SBL	SBT	SBR
Lane Configurations	115	1017	3	2	853	12	0	7	26	0
Traffic Volume (veh/h)	115	1017	3	2	853	12	0	7	26	0
Future Volume (veh/h)	0	0	0	0	0	0	0	0	0	0
Initial Q (Qb), veh	1.00	1.00	1.00	1.00	1.00	1.00	1.00	1.00	1.00	1.00
Ped-Bike Adj(A_pbT)	No	No	No	No	No	No	No	No	No	No
Parking Bus, Adj	1870	1870	1870	1870	1870	1870	1870	1870	1870	1870
Work Zone On Approach	128	1130	3	2	948	13	0	8	29	0
Adj Sat Flow, veh/h	0.90	0.90	0.90	0.90	0.90	0.90	0.90	0.90	0.90	0.90
Adj Flow Rate, veh/h	2	2	2	2	2	2	2	2	2	2
Peak Hour Factor	210	1517	4	195	1161	16	0	771	737	0
Percent Heavy Veh, %	0.13	0.83	0.83	0.22	0.22	0.22	0.00	0.49	0.49	0.00
Cap, veh/h	1781	3636	10	497	3589	49	0	1885	1407	0
Arrive On Green	128	552	581	2	469	492	0	8	29	0
Sat Flow, veh/h	1781	1777	1869	497	1777	1862	0	1585	1407	0
Grp Volume(v), veh/h	6.1	17.7	17.7	0.4	32.7	32.7	0.0	0.3	1.4	0.0
Grp Sat Flow(s), veh/h	6.1	17.7	17.7	5.9	32.7	32.7	0.0	0.3	1.7	0.0
Q Serve(g_s), s	1.00	1.00	1.00	1.00	1.00	1.00	1.00	1.00	1.00	1.00
Cycle Q Clear(g_c), s	210	741	780	195	575	602	0	771	737	0
Prop In Lane	0.61	0.74	0.74	0.01	0.82	0.82	0.00	0.01	0.04	0.00
VC Ratio(X)	317	1196	1258	292	923	967	0	771	737	0
Avail Cap(c_a), veh/h	2.00	2.00	2.00	0.67	0.67	0.67	1.00	1.00	1.00	1.00
HCM Platoon Ratio	0.90	0.90	0.90	1.00	1.00	1.00	0.00	0.00	0.00	0.00
Upstream Filter(i)	28.8	7.7	7.7	39.0	47.2	47.2	0.0	17.2	17.7	0.0
Uniform Delay (d), s/veh	2.6	1.4	1.3	0.0	3.1	2.9	0.0	0.0	0.1	0.0
Incr Delay (d2), s/veh	0.0	0.0	0.0	0.0	0.0	0.0	0.0	0.0	0.0	0.0
Initial Q Delay(Q3), s/veh	2.5	3.4	3.6	0.1	15.5	16.2	0.0	0.1	0.5	0.0
%ile Back(Q50%), s/veh	31.4	9.1	9.0	39.0	50.3	50.2	0.0	17.2	17.8	0.0
Unsig. Movement Delay, s/veh	C	A	A	D	D	D	A	A	B	A
LnGrp Delay(d) s/veh	1261	11.3	50.2	963	8	101	17.2	18.1	18.1	101
LnGrp LOS	B	B	D	D	B	B	B	B	B	B
Approach Vol, veh/h	2	4	6	7	8	8	8	8	8	8
Approach Delay, s/veh	69.3	60.7	69.3	122	48.6	48.6	6.0	6.0	4.0	6.5
Approach LOS	30.0	87.5	30.0	16.0	67.5	67.5	2.3	19.7	5.2	8.1
Timer - Assigned Phs	0.0	10.3	0.4	0.2	7.4	7.4	0.0	0.0	0.0	0.0
Phs Duration (G+Y+Rc), s	27.7	27.7	27.7	27.7	27.7	27.7	27.7	27.7	27.7	27.7
Change Period (Y+Rc), s	6.0	6.5	6.0	4.0	6.5	6.5	6.0	6.0	4.0	6.5
Max Green Setting (Gmax), s	30.0	87.5	30.0	16.0	67.5	67.5	2.3	19.7	5.2	8.1
Max Q Clear Time (g_c+I1), s	0.0	10.3	0.4	0.2	7.4	7.4	0.0	0.0	0.0	0.0
Green Ext Time (g_e), s	Intersection Summary									
Green Ext Time (g_e), s	HCM 6th Ctrl Delay									
Intersection Summary	C									
HCM 6th Ctrl Delay	27.7									
HCM 6th LOS	C									

Smoke Tree Resort
2020 Background AM

3: Smoke Tree West & Lincoln Dr
HCM 6th TWSC

Intersection	Init Delay, s/veh									
	0									
Movement	EBT	EBR	WBL	WBT	NBL	NBR				
Lane Configurations	↔	↔	↔	↔	↔	↔				
Traffic Vol, veh/h	1047	2	0	863	0	0				
Future Vol, veh/h	1047	2	0	863	0	0				
Conflicting Peds, #/hr	0	0	0	0	0	0				
Sign Control	Free	Free	Free	Free	Stop	Stop				
RT Channelized	-	None	-	None	-	None				
Storage Length	-	-	25	-	0	-				
Veh in Median Storage, #	0	-	-	0	0	-				
Grade, %	0	-	-	-	0	0				
Peak Hour Factor	90	90	90	90	90	90				
Heavy Vehicles, %	2	2	2	2	2	2				
Mvmt Flow	1163	2	0	959	0	0				
Major/Minor	Major1	Major2	Minor1							
Conflicting Flow All	0	0	1165	0	1644	583				
Stage 1	-	-	-	-	1164	-				
Stage 2	-	-	-	-	480	-				
Critical Hdwy	-	-	4.14	-	6.84	6.94				
Critical Hdwy Stg 1	-	-	-	-	5.84	-				
Critical Hdwy Stg 2	-	-	-	-	5.84	-				
Follow-up Hdwy	-	-	2.22	-	3.52	3.32				
Pl Cap-1 Maneuver	-	-	595	-	90	456				
Stage 1	-	-	-	-	259	-				
Stage 2	-	-	-	-	588	-				
Platoon blocked, %	-	-	-	-	-	-				
Mov Cap-1 Maneuver	-	-	595	-	90	456				
Mov Cap-2 Maneuver	-	-	-	-	197	-				
Stage 1	-	-	-	-	259	-				
Stage 2	-	-	-	-	588	-				
Approach	EB	WB	NB							
HCM Control Delay, s	0	0	0							
HCM LOS				A						
Minor Lane/Major Mvmt	NBLn1	EBT	EBR	WBL	WBT					
Capacity (veh/h)	-	-	-	-	595					
HCM Lane V/C Ratio	-	-	-	-	-					
HCM Control Delay (s)	0	-	-	0	-					
HCM Lane LOS	A	-	-	A	-					
HCM 95th %tile Q(veh)	-	-	-	0	-					

Smoke Tree Resort
2020 Background AM

4: Smoke Tree East & Lincoln Dr
HCM 6th TWSC

Intersection	Init Delay, s/veh									
	0.1									
Movement	EBT	EBR	WBL	WBT	NBL	NBR				
Lane Configurations	↔	↔	↔	↔	↔	↔				
Traffic Vol, veh/h	1049	0	1	860	5	2				
Future Vol, veh/h	1049	0	1	860	5	2				
Conflicting Peds, #/hr	0	0	0	0	0	0				
Sign Control	Free	Free	Free	Free	Stop	Stop				
RT Channelized	-	None	-	None	-	None				
Storage Length	-	-	25	-	0	-				
Veh in Median Storage, #	0	-	-	0	0	-				
Grade, %	0	-	-	-	0	0				
Peak Hour Factor	90	90	90	90	90	90				
Heavy Vehicles, %	2	2	2	2	2	2				
Mvmt Flow	1166	0	1	956	6	2				
Major/Minor	Major1	Major2	Minor1							
Conflicting Flow All	0	0	1166	0	1646	583				
Stage 1	-	-	-	-	1166	-				
Stage 2	-	-	-	-	480	-				
Critical Hdwy	-	-	4.14	-	6.84	6.94				
Critical Hdwy Stg 1	-	-	-	-	5.84	-				
Critical Hdwy Stg 2	-	-	-	-	5.84	-				
Follow-up Hdwy	-	-	2.22	-	3.52	3.32				
Pl Cap-1 Maneuver	-	-	595	-	90	456				
Stage 1	-	-	-	-	259	-				
Stage 2	-	-	-	-	588	-				
Platoon blocked, %	-	-	-	-	-	-				
Mov Cap-1 Maneuver	-	-	595	-	90	456				
Mov Cap-2 Maneuver	-	-	-	-	197	-				
Stage 1	-	-	-	-	258	-				
Stage 2	-	-	-	-	588	-				
Approach	EB	WB	NB							
HCM Control Delay, s	0	0	0							
HCM LOS				C						
Minor Lane/Major Mvmt	NBLn1	EBT	EBR	WBL	WBT					
Capacity (veh/h)	235	-	-	-	595					
HCM Lane V/C Ratio	0.033	-	-	0.002	-					
HCM Control Delay (s)	20.8	-	-	11.1	-					
HCM Lane LOS	C	-	-	B	-					
HCM 95th %tile Q(veh)	0.1	-	-	0	-					

Smoke Tree Resort
2020 Background AM

5: Lincoln Medical West & Lincoln Dr
HCM 6th TWSC

Intersection	EBT	EBR	WBL	WBT	NBL	NBR
Int'l Delay, s/veh	0.4					
Movement	EBT	EBR	WBL	WBT	NBL	NBR
Lane Configurations	↑↑	↑↑	↑↑	↑↑	↑↑	↑↑
Traffic Vol, veh/h	1034	17	42	854	6	9
Future Vol, veh/h	1034	17	42	854	6	9
Conflicting Peds, #/hr	0	0	0	0	0	0
Sign Control	Free	Free	Free	Free	Stop	Stop
RT Channelized	-	None	-	None	-	None
Storage Length	-	-	25	-	0	-
Veh in Median Storage, #	0	-	-	0	0	-
Grade, %	0	-	-	-	0	0
Peak Hour Factor	90	90	90	90	90	90
Heavy Vehicles, %	2	2	2	2	2	2
Mvmt Flow	1149	19	47	949	7	10
Major/Minor	Major1	Major2	Minor1	Minor1	Minor1	Minor1
Conflicting Flow All	0	0	1168	0	1728	584
Stage 1	-	-	-	-	1159	-
Stage 2	-	-	-	-	-	569
Critical Hdwy	-	-	4.14	-	6.84	6.94
Critical Hdwy Stg 1	-	-	-	-	5.84	-
Critical Hdwy Stg 2	-	-	-	-	5.84	-
Follow-up Hdwy	-	-	2.22	-	3.52	3.32
Pl Cap-1 Maneuver	-	-	594	-	79	455
Stage 1	-	-	-	-	261	-
Stage 2	-	-	-	-	-	530
Platoon blocked, %	-	-	-	-	-	-
Mov Cap-1 Maneuver	-	-	594	-	73	455
Mov Cap-2 Maneuver	-	-	-	-	175	-
Stage 1	-	-	-	-	240	-
Stage 2	-	-	-	-	-	530
Approach	EB	WB	NB	NB	NB	NB
HCM Control Delay, s	0	0.5	18.8	18.8	18.8	18.8
HCM LOS	C					
Minor Lane/Major Mvmt	NBLn1	EBT	EBR	WBL	WBT	WBT
Capacity (veh/h)	277	-	-	594	-	-
HCM Lane V/C Ratio	0.06	-	-	0.079	-	-
HCM Control Delay (s)	18.8	-	-	11.6	-	-
HCM Lane LOS	C	-	-	B	-	-
HCM 95th %ile Q(veh)	0.2	-	-	0.3	-	-

Smoke Tree Resort
2020 Background AM

6: Lincoln Medical East & Lincoln Dr
HCM 6th TWSC

Intersection	EBT	EBR	WBL	WBT	NBL	NBR
Int'l Delay, s/veh	0.1					
Movement	EBT	EBR	WBL	WBT	NBL	NBR
Lane Configurations	↑↑	↑↑	↑↑	↑↑	↑↑	↑↑
Traffic Vol, veh/h	1030	11	5	896	0	9
Future Vol, veh/h	1030	11	5	896	0	9
Conflicting Peds, #/hr	0	0	0	0	0	0
Sign Control	Free	Free	Free	Free	Stop	Stop
RT Channelized	-	None	-	None	-	None
Storage Length	-	-	25	-	0	-
Veh in Median Storage, #	0	-	-	0	0	-
Grade, %	0	-	-	-	0	0
Peak Hour Factor	90	90	90	90	90	90
Heavy Vehicles, %	2	2	2	2	2	2
Mvmt Flow	1144	12	6	996	0	10
Major/Minor	Major1	Major2	Minor1	Minor1	Minor1	Minor1
Conflicting Flow All	0	0	1156	0	1660	578
Stage 1	-	-	-	-	1150	-
Stage 2	-	-	-	-	-	510
Critical Hdwy	-	-	4.14	-	6.84	6.94
Critical Hdwy Stg 1	-	-	-	-	5.84	-
Critical Hdwy Stg 2	-	-	-	-	5.84	-
Follow-up Hdwy	-	-	2.22	-	3.52	3.32
Pl Cap-1 Maneuver	-	-	600	-	88	459
Stage 1	-	-	-	-	264	-
Stage 2	-	-	-	-	-	568
Platoon blocked, %	-	-	-	-	-	-
Mov Cap-1 Maneuver	-	-	600	-	87	459
Mov Cap-2 Maneuver	-	-	-	-	196	-
Stage 1	-	-	-	-	261	-
Stage 2	-	-	-	-	-	568
Approach	EB	WB	NB	NB	NB	NB
HCM Control Delay, s	0	0.1	13	13	13	13
HCM LOS	B					
Minor Lane/Major Mvmt	NBLn1	EBT	EBR	WBL	WBT	WBT
Capacity (veh/h)	459	-	-	600	-	-
HCM Lane V/C Ratio	0.022	-	-	0.009	-	-
HCM Control Delay (s)	13	-	-	11.1	-	-
HCM Lane LOS	B	-	-	B	-	-
HCM 95th %ile Q(veh)	0.1	-	-	0	-	-

Smoke Tree Resort
2020 Background AM

7: Apartment Drwy & Lincoln Dr
HCM 6th TWSC

Intersection													
Init Delay, s/veh													
1,1													
EBL	EBT	EBR	WBL	WBT	WBR	NBL	NBT	NBR	SBL	SBT	SBR		
27	979	35	19	836	10	52	0	30	5	0	12		
Future Vol, veh/h	27	979	35	19	836	10	52	0	30	5	0	12	
Conflicting Peds, #/hr	0	0	0	0	0	0	0	0	0	0	0	0	0
Sign Control	Free	Free	Free	Free	Free	Free	Free	Free	Free	Free	Free	Free	Free
RT Channelized	-	-	-	-	-	-	-	-	-	-	-	-	-
Storage Length	25	-	-	25	-	-	-	-	-	-	-	-	-
Veh in Median Storage, #	-	0	-	-	0	-	-	0	-	-	0	-	-
Grade, %	-	0	-	-	0	-	-	0	-	-	0	-	-
Peak Hour Factor	90	90	90	90	90	90	90	90	90	90	90	90	90
Heavy Vehicles, %	2	2	2	2	2	2	2	2	2	2	2	2	2
Mvmt Flow	30	1088	39	21	929	11	58	0	33	6	0	13	
Major/Minor													
Major1 Major2 Minor1 Minor2													
Conflicting Flow All	940	0	0	1127	0	0	1675	2150	564	1581	-	470	
Stage 1	-	-	-	-	-	-	1168	1168	-	977	-	-	-
Stage 2	-	-	-	-	-	-	507	982	-	604	-	-	-
Critical Hdwy	4.14	-	-	4.14	-	-	7.54	6.54	6.94	7.54	-	6.94	-
Critical Hdwy Stg 1	-	-	-	-	-	-	6.54	5.54	-	6.54	-	-	-
Critical Hdwy Stg 2	-	-	-	-	-	-	6.54	5.54	-	6.54	-	-	-
Follow-up Hdwy	2.22	-	-	2.22	-	-	3.52	4.02	3.32	3.52	-	3.32	-
Pot Cap-1 Maneuver	725	-	-	616	-	-	62	48	469	73	0	540	-
Stage 1	-	-	-	-	-	-	206	266	-	269	0	-	-
Stage 2	-	-	-	-	-	-	516	325	-	452	0	-	-
Platoon blocked, %	-	-	-	-	-	-	-	-	-	-	-	-	-
Mov Cap-1 Maneuver	725	-	-	616	-	-	-57	44	469	64	-	540	-
Mov Cap-2 Maneuver	-	-	-	-	-	-	-57	44	-	64	-	-	-
Stage 1	-	-	-	-	-	-	198	255	-	258	-	-	-
Stage 2	-	-	-	-	-	-	486	314	-	403	-	-	-
Approach													
EB WB NB SB													
HCM Control Delay, s	0.3			0.2			212.8			27.9			
HCM LOS							F			D			
Minor Lane/Major Mvmt													
NBLn1 EBL EBT EBR WBL WBT WBR SBLn1 SBLn2													
Capacity (veh/h)	84	725	-	-	616	-	-	64	540	-	-	64	540
HCM Lane V/C Ratio	1.085	0.041	-	-	0.034	-	-	0.087	0.025	-	-	0.087	0.025
HCM Control Delay (s)	212.8	10.2	-	-	11.1	-	-	66.5	11.8	-	-	66.5	11.8
HCM Lane LOS	F	B	-	-	B	-	-	F	B	-	-	F	B
HCM 95th %ile Q(veh)	6.3	0.1	-	-	0.1	-	-	0.3	0.1	-	-	0.3	0.1
Notes													
- Volume exceeds capacity \$ Delay exceeds 300s +- Computation Not Defined *: All major volume in platoon													

Smoke Tree Resort
2020 Background AM

8: AJ's Drwy & Lincoln Dr
HCM 6th TWSC

Intersection													
Init Delay, s/veh													
1,1													
EBL	EBT	EBR	WBL	WBT	WBR	NBL	NBT	NBR	SBL	SBT	SBR		
3	958	55	44	848	8	6	0	42	4	1	12		
Future Vol, veh/h	3	958	55	44	848	8	6	0	42	4	1	12	
Conflicting Peds, #/hr	0	0	0	0	0	0	0	0	0	0	0	0	0
Sign Control	Free	Free	Free	Free	Free	Free	Free	Free	Free	Free	Free	Free	Free
RT Channelized	-	-	-	-	-	-	-	-	-	-	-	-	-
Storage Length	25	-	-	25	-	-	-	-	-	-	-	-	-
Veh in Median Storage, #	-	0	-	-	0	-	-	0	-	-	0	-	-
Grade, %	-	0	-	-	0	-	-	0	-	-	0	-	-
Peak Hour Factor	90	90	90	90	90	90	90	90	90	90	90	90	90
Heavy Vehicles, %	2	2	2	2	2	2	2	2	2	2	2	2	2
Mvmt Flow	3	1064	61	49	942	9	7	0	47	4	1	13	
Major/Minor													
Major1 Major2 Minor1 Minor2													
Conflicting Flow All	951	0	0	1125	0	0	1671	2150	563	1583	2176	476	
Stage 1	-	-	-	-	-	-	1101	1101	-	1045	1045	-	-
Stage 2	-	-	-	-	-	-	570	1049	-	538	1131	-	-
Critical Hdwy	4.14	-	-	4.14	-	-	7.54	6.54	6.94	7.54	6.54	6.94	-
Critical Hdwy Stg 1	-	-	-	-	-	-	6.54	5.54	-	6.54	5.54	-	-
Critical Hdwy Stg 2	-	-	-	-	-	-	6.54	5.54	-	6.54	5.54	-	-
Follow-up Hdwy	2.22	-	-	2.22	-	-	3.52	4.02	3.32	3.52	4.02	3.32	-
Pot Cap-1 Maneuver	718	-	-	617	-	-	63	48	470	73	46	535	-
Stage 1	-	-	-	-	-	-	226	286	-	245	304	-	-
Stage 2	-	-	-	-	-	-	474	303	-	495	277	-	-
Platoon blocked, %	-	-	-	-	-	-	-	-	-	-	-	-	-
Mov Cap-1 Maneuver	718	-	-	617	-	-	56	44	470	62	42	535	-
Mov Cap-2 Maneuver	-	-	-	-	-	-	56	44	-	62	42	-	-
Stage 1	-	-	-	-	-	-	225	285	-	244	280	-	-
Stage 2	-	-	-	-	-	-	424	279	-	444	276	-	-
Approach													
EB WB NB SB													
HCM Control Delay, s	0			0.6			23.8			25.8			
HCM LOS							C			D			
Minor Lane/Major Mvmt													
NBLn1 EBL EBT EBR WBL WBT WBR SBLn1 SBLn2													
Capacity (veh/h)	244	718	-	-	617	-	-	62	535	-	-	62	535
HCM Lane V/C Ratio	0.219	0.005	-	-	0.079	-	-	0.072	0.025	-	-	0.072	0.025
HCM Control Delay (s)	23.8	10	-	-	11.3	-	-	67.5	11.9	-	-	67.5	11.9
HCM Lane LOS	C	B	-	-	B	-	-	F	B	-	-	F	B
HCM 95th %ile Q(veh)	0.8	0	-	-	0.3	-	-	0.2	0.1	-	-	0.2	0.1
Notes													
- Volume exceeds capacity \$ Delay exceeds 300s +- Computation Not Defined *: All major volume in platoon													

Smoke Tree Resort
2020 Background AM

9: Scottsdale Rd & Lincoln Dr
Timings

	EBL	EBT	EBR	WBL	WBT	NBL	NBT	SBL	SBT	SBR	
Lane Group											
Lane Configurations	450	38	460	37	36	295	1316	51	1669	601	
Traffic Volume (vph)	450	38	460	37	36	295	1316	51	1669	601	
Future Volume (vph)	Split	NA	pm+ov	Split	NA	Prdt	NA	Prdt	NA	pm+ov	
Turn Type	4	4	5	8	8	5	2	1	6	4	
Protected Phases	4	4	5	8	8	5	2	1	6	4	
Permitted Phases	4	4	5	8	8	5	2	1	6	4	
Detector Phase											
Switch Phase											
Minimum Initial (s)	7.0	7.0	7.0	7.0	7.0	10.0	10.0	5.0	10.0	7.0	
Minimum Split (s)	13.0	13.0	13.0	13.0	13.0	16.7	11.0	16.0	13.0		
Total Split (s)	30.0	30.0	30.0	30.0	30.0	73.0	14.0	57.0	30.0		
Total Split (%)	23.1%	23.1%	23.1%	10.0%	10.0%	56.2%	10.8%	43.8%	23.1%		
Yellow Time (s)	4.0	4.0	4.0	3.6	3.6	4.0	4.7	3.3	4.7	4.0	
All-Red Time (s)	1.5	1.5	1.5	2.0	2.0	1.5	1.0	2.0	1.0	1.5	
Lost Time Adjust (s)	0.0	0.0	0.0	0.0	0.0	0.0	0.0	0.0	0.0	0.0	
Total Lost Time (s)	5.5	5.5	5.5	5.6	5.6	5.5	5.7	5.3	5.7	5.5	
Lead/Lag				Lead	Lead	Lag	Lag	Lead	Lag		
Lead-Lag Optimize?	None	None	None	None	None	None	None	None	C-Max	None	
Recall Mode	23.6	23.6	42.3	7.2	7.2	18.7	71.5	7.6	58.1	87.4	
Act Effct Green (s)	0.18	0.18	0.33	0.06	0.06	0.14	0.55	0.06	0.45	0.67	
Actuated g/C Ratio	0.89	0.88	0.91	0.42	0.40	0.66	0.54	0.55	0.82	0.59	
v/c Ratio	81.3	80.8	47.0	72.5	33.9	58.8	20.4	79.0	35.9	10.8	
Control Delay	0.0	0.0	0.0	0.0	0.0	0.0	0.0	0.0	0.0	0.0	
Queue Delay	0.0	0.0	0.0	0.0	0.0	0.0	0.0	0.0	0.0	0.0	
Total Delay	F	F	D	E	C	E	C	E	C	D	B
LOS	F	F	D	E	C	E	C	E	C	D	B
Approach Delay	64.5			45.7		27.3		30.4			
Approach LOS	E			D		C		C			
Intersection Summary											
Cycle Length: 130											
Actuated Cycle Length: 130											
Offset: 0 (0%), Referenced to phase 6, SBT, Start of Green											
Natural Cycle: 90											
Control Type: Actuated-Coordinated											
Maximum v/c Ratio: 0.91											
Intersection Signal Delay: 36.1											
Intersection Capacity Utilization 80.6%											
Analysis Period (min) 15											

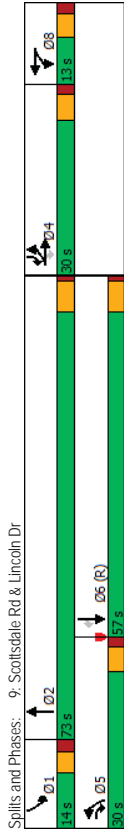

Smoke Tree Resort
2020 Background AM

9: Scottsdale Rd & Lincoln Dr
HCM 6th Signalized Intersection Summary

	EBL	EBT	EBR	WBL	WBT	NBL	NBT	SBL	SBT	SBR	
Movement											
Lane Configurations	450	38	460	37	36	295	1316	51	1669	601	
Traffic Volume (veh/h)	450	38	460	37	36	295	1316	51	1669	601	
Future Volume (veh/h)	0	0	0	0	0	0	0	0	0	0	
Initial Q (Ob), veh	1.00	1.00	1.00	1.00	1.00	1.00	1.00	1.00	1.00	1.00	
Ped-Bike Adj(A_pbT)	1.00	1.00	1.00	1.00	1.00	1.00	1.00	1.00	1.00	1.00	
Parking Bus, Adj	No	No	No	No	No	No	No	No	No	No	
Work Zone On Approach	No	No	No	No	No	No	No	No	No	No	
Adj Sat Flow, veh/h	1870	1870	1870	1870	1870	1870	1870	1870	1870	1870	
Adj Flow Rate, veh/h	530	0	511	41	40	53	328	1462	43	57	
Peak Hour Factor	0.90	0.90	0.90	0.90	0.90	0.90	0.90	0.90	0.90	0.90	
Percent Heavy Veh, %	2	2	2	2	2	2	2	2	2	2	
Cap, veh/h	671	0	477	95	95	85	388	2382	70	73	
Arrive On Green	0.19	0.00	0.19	0.05	0.05	0.05	0.11	0.47	0.47	0.04	
Sat Flow, veh/h	3563	0	1585	1781	1777	1585	3456	5098	150	1781	
Grp Volume(v), veh/h	530	0	511	41	40	53	328	976	529	57	
Grp Sat Flow(s),veh/h	1781	0	1585	1781	1777	1585	1728	1702	1843	1781	
Q Serve(g.s), s	18.4	0.0	24.5	2.9	2.8	4.3	12.1	27.9	27.9	4.1	
Cycle O Clear(g.c), s	18.4	0.0	24.5	2.9	2.8	4.3	12.1	27.9	27.9	4.1	
Prop In Lane	1.00	1.00	1.00	1.00	1.00	1.00	1.00	1.00	1.00	1.00	
Lane Grp Cap(c), veh/h	671	0	477	95	95	85	388	1590	861	73	
v/c Ratio(x)	0.79	0.00	1.07	0.43	0.42	0.63	0.85	0.61	0.61	0.78	
Avail Cap(c,a), veh/h	671	0	477	101	101	90	651	1762	954	119	
HCM Platoon Ratio	1.00	1.00	1.00	1.00	1.00	1.00	1.00	1.00	1.00	1.00	
Upstream Filter()	1.00	0.00	1.00	1.00	1.00	1.00	1.00	1.00	1.00	1.00	
Uniform Delay (d), veh/h	50.3	0.0	45.5	59.6	59.6	60.3	56.6	25.9	25.9	61.7	
Incr Delay (d2), veh/h	5.8	0.0	61.9	1.1	1.1	8.2	2.2	0.3	0.6	6.5	
Initial Q Delay(d3),s/veh	0.0	0.0	0.0	0.0	0.0	0.0	0.0	0.0	0.0	0.0	
%ile BackOfQ(60%),veh/h	8.8	0.0	23.4	1.3	1.3	1.9	5.4	11.3	12.3	2.0	
Unsig. Movement Delay, s/veh	56.1	0.0	107.4	60.8	60.7	68.4	58.8	26.2	26.5	68.2	
LnGrp Delay(d)s/veh	E	A	F	E	E	E	E	C	C	E	
LnGrp LOS	E	A	F	E	E	E	E	C	C	E	
Approach Vol, veh/h	1041			134			1833			2579	
Approach Delay, s/veh	81.3			63.8			32.1			40.7	
Approach LOS	F			E			C			D	
Timer - Assigned Phs	1	2	4	5	6	8					
Phs Duration (G+Y+Rc), s	10.6	66.4	30.0	20.1	57.0	12.5					
Change Period (Y+Rc), s	* 5.3	5.7	5.5	5.5	5.7	5.6					
Max Green Setting (Gmax), s	* 8.7	67.3	24.5	24.5	51.3	7.4					
Max Q Clear Time (g_c+I1), s	6.1	29.9	26.5	14.1	46.9	6.3					
Green Ext Time (g_e), s	0.0	2.2	0.0	0.5	1.9	0.0					
Intersection Summary											
HCM 6th Ctrl Delay	46.0										
HCM 6th LOS	D										
Notes											
User approved pedestrian interval to be less than phase max green.											
User approved volume balancing among the lanes for turning movement.											
* HCM 6th computational engine requires equal clearance times for the phases crossing the barrier.											

Smoke Tree Resort
2020 Background PM

1: Mockingbird Ln & Lincoln Drive
HCM 6th Signalized Intersection Summary

	EBT	WBL	WBT	NBL	NBT	SBL	SBT
Lane Group	EBL	EBT	WBL	WBT	NBL	NBT	SBL
Lane Configurations	←	←	←	←	←	←	←
Traffic Volume (vph)	246	875	23	937	7	62	62
Future Volume (vph)	246	875	23	937	7	62	62
Turn Type	pm-plt	NA	Perm	NA	pm+plt	NA	NA
Protected Phases	1	6	2	2	4	3	8
Permitted Phases	6	6	2	2	4	4	8
Detector Phase	1	6	2	2	4	4	3
Switch Phase							
Minimum Initial (s)	4.0	15.0	15.0	15.0	7.0	4.0	7.0
Minimum Split (s)	8.0	27.0	27.0	27.0	33.5	8.0	33.5
Total Split (s)	31.0	88.0	57.0	57.0	34.0	8.0	42.0
Total Split (%)	23.8%	67.7%	43.8%	43.8%	26.2%	6.2%	32.3%
Yellow Time (s)	3.0	4.5	4.5	4.5	4.0	3.0	4.0
All-Red Time (s)	1.0	1.5	1.5	1.5	2.5	1.0	2.5
Lost Time Adjust (s)	0.0	0.0	0.0	0.0	0.0	0.0	0.0
Total Lost Time (s)	4.0	6.0	6.0	6.0	6.5	4.0	6.5
Lead/Lag	Lead	Lag	Lag	Lag	Lag	Lead	Lead
Lead-Lag Optimize?	Yes	Yes	Yes	Yes	Yes	Yes	Yes
Recall Mode	None	C-Max	C-Max	C-Max	None	None	None
Act Effct Green (s)	101.9	99.9	78.3	78.3	11.2	20.1	17.6
Actuated g/C Ratio	0.78	0.77	0.60	0.60	0.09	0.15	0.14
v/C Ratio	0.59	0.37	0.08	0.53	0.10	0.54	0.68
Control Delay	11.1	5.8	13.7	23.6	55.4	62.1	33.7
Queue Delay	0.0	0.0	0.0	0.0	0.0	0.0	0.0
Total Delay	11.1	5.8	13.7	23.6	55.4	62.1	33.7
LOS	B	A	B	C	E	E	D
Approach Delay	6.9	A	B	C	E	E	D
Approach LOS	A	A	C	C	E	E	D
Intersection Summary							
Cycle Length: 130							
Actuated Cycle Length: 130							
Offset: 0 (0%), Referenced to phase 2:WBT and 6:EBTL, Start of Green							
Natural Cycle: 90							
Control Type: Actuated-Coordinated							
Maximum v/C Ratio: 0.68							
Intersection Signal Delay: 18.8							
Intersection Capacity Utilization 67.4%							
Analysis Period (min) 15							

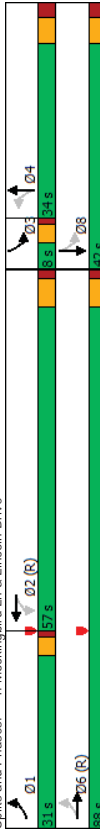

Smoke Tree Resort
2020 Background PM

1: Mockingbird Ln & Lincoln Drive
HCM 6th Signalized Intersection Summary

	EBL	EBT	WBL	WBT	NBL	NBT	SBL	SBT	SBR
Lane Configurations	←	←	←	←	←	←	←	←	←
Traffic Volume (veh/h)	246	875	29	937	63	7	62	18	62
Future Volume (veh/h)	246	875	29	937	63	7	62	18	62
Initial Q (Obs.) veh	0	0	0	0	0	0	0	0	0
Ped-Bike Adj(A_pbT)	1.00	1.00	1.00	1.00	1.00	1.00	1.00	1.00	1.00
Parking Bus, Adj	1.00	1.00	1.00	1.00	1.00	1.00	1.00	1.00	1.00
Work Zone On Approach	No	No	No	No	No	No	No	No	No
Adj Sat Flow (veh/h)	1870	1870	1870	1870	1870	1870	1870	1870	1870
Adj Flow Rate, veh/h	273	912	32	26	1041	70	8	69	20
Peak Hour Factor	0.90	0.90	0.90	0.90	0.90	0.90	0.90	0.90	0.90
Percent Heavy Veh. %	2	2	2	2	2	2	2	2	2
Cap. veh/h	469	2615	86	417	2177	146	84	136	39
Arrive On Green	0.07	0.74	0.14	0.86	0.86	0.86	0.10	0.10	0.03
Sat Flow, veh/h	1781	3511	116	561	3379	227	1155	1394	404
Grp Sat Flow(s),veh/h	1781	1777	1850	561	1777	1829	1155	0	1798
Q Serve(g.s) s	6.4	12.7	12.7	0.9	9.7	9.7	10.3	0.0	6.1
Cycle Q Clear(g.c) s	6.4	12.7	12.7	0.9	9.7	9.7	10.3	0.0	6.1
Prop In Lane	1.00	0.06	1.00	1.00	0.12	1.00	0.22	1.00	0.77
Lane Grp Cap(c) veh/h	469	1324	1378	417	1144	1178	84	0	175
V/C Ratio(X)	0.58	0.37	0.37	0.06	0.48	0.48	0.10	0.00	0.51
Avail Cap(c.a) veh/h	714	1324	1378	417	1144	1178	216	0	380
HCM Platoon Ratio	1.00	1.00	1.00	1.33	1.33	1.33	1.00	1.00	1.00
Upstream Filter()	1.00	1.00	1.00	0.55	0.55	0.55	1.00	0.00	1.00
Uniform Delay (d) s/veh	6.8	5.8	5.8	3.4	4.0	4.0	6.22	0.0	55.7
Incr Delay (d2) s/veh	1.1	0.8	0.8	0.2	0.8	0.8	0.5	0.0	2.3
Initial Q Delay(g3) s/veh	0.0	0.0	0.0	0.0	0.0	0.0	0.0	0.0	0.0
%ile BackQ(50%) veh/m	2.3	4.6	4.8	0.1	2.8	2.8	0.3	0.0	2.9
Unsig. Movement Delay, s/veh	7.9	6.6	6.6	3.5	4.8	4.8	6.27	0.0	58.0
LnGrp Delay(d) s/veh	A	A	A	A	A	A	E	A	D
LnGrp LOS	A	A	A	A	A	A	E	A	D
Approach Vol. veh/h	1277								97
Approach Delay, s/veh	6.9								58.4
Approach LOS	A								E
Timer - Assigned Phs	1	2	3	4	6	8			
Phs Duration (G+Y+Rc) s	13.1	89.7	8.0	19.2	102.8	27.2			
Change Period (Y+Rc) s	4.0	6.0	4.0	6.5	6.0	6.5			
Max Green Setting (Gmax) s	27.0	51.0	4.0	27.5	82.0	35.5			
Max Q Clear Time (g_c+I1) s	8.4	11.7	6.0	12.3	14.7	19.4			
Green EXT Time (p_c) s	0.7	9.9	0.0	0.3	8.5	1.2			
Intersection Summary									
HCM 6th Ctrl Delay	13.4								
HCM 6th LOS	B								

Smoke Tree Resort
2020 Background PM

2: Quail Run Rd & Lincoln Drive
HCM 6th Signalized Intersection Summary

	EBL	EBT	WBT	NBT	SBL	SBT
Lane Group	EBL	EBT	WBT	NBT	SBL	SBT
Lane Configurations	5	4	4	4	4	4
Traffic Volume (vph)	85	886	929	0	14	0
Future Volume (vph)	85	886	929	0	14	0
Turn Type	pm-plt	NA	NA	NA	Perm	NA
Protected Phases	7	4	8	2	6	6
Permitted Phases	4	4	8	2	6	6
Detector Phase						
Switch Phase						
Minimum Initial (s)	3.5	15.0	15.0	7.0	7.0	7.0
Minimum Split (s)	8.0	28.0	28.0	33.0	33.0	33.0
Total Split (s)	20.0	94.0	74.0	36.0	36.0	36.0
Total Split (%)	15.4%	72.3%	56.9%	27.7%	27.7%	27.7%
Yellow Time (s)	3.0	4.0	4.0	4.5	4.5	4.5
All-Red Time (s)	1.0	2.5	2.5	1.5	1.5	1.5
Lost Time Adjust (s)	0.0	0.0	0.0	0.0	0.0	0.0
Total Lost Time (s)	4.0	6.5	6.5	6.0	6.0	6.0
Lead/Lag	Lead	Lag	Lag	Lag	Lag	Lag
Lead-Lag Optimize?	Yes	Yes	Yes	Yes	Yes	Yes
Recall Mode	None	None	None	C-Max	C-Max	C-Max
Act Effct Green (s)	67.4	64.9	50.7	52.6	52.6	52.6
Actuated g/C Ratio	0.52	0.50	0.39	0.40	0.40	0.40
v/c Ratio	0.42	0.56	0.77	0.00	0.03	0.13
Control Delay	26.7	31.8	38.2	0.0	28.5	0.3
Queue Delay	0.0	0.0	0.0	0.0	0.0	0.0
Total Delay	26.7	31.8	38.2	0.0	28.5	0.3
LOS	C	C	D	A	C	A
Approach Delay		31.4	38.2			4.1
Approach LOS		C	D			A

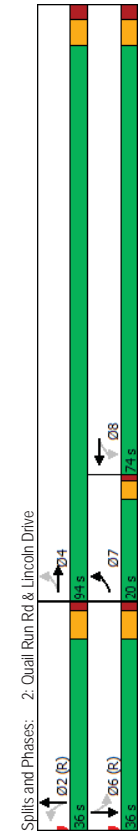

Smoke Tree Resort
2020 Background PM

2: Quail Run Rd & Lincoln Drive
HCM 6th Signalized Intersection Summary

	EBL	EBT	WBL	NBL	SBL	SBT
Movement	EBL	EBT	WBL	NBL	SBL	SBT
Lane Configurations	5	4	4	4	4	4
Traffic Volume (veh/h)	85	886	929	25	14	0
Future Volume (veh/h)	85	886	929	25	14	0
Initial Q (Obs.) veh	0	0	0	0	0	0
Ped-Bike Adj(A_pbT)	1.00	1.00	1.00	1.00	1.00	1.00
Parking Bus, Adj	No	No	No	No	No	No
Work Zone On Approach	No	No	No	No	No	No
Adj Sat Flow (veh/h)	1870	1870	1870	1870	1870	1870
Adj Flow Rate (veh/h)	94	984	1032	28	16	0
Peak Hour Factor	0.90	0.90	0.90	0.90	0.90	0.90
Percent Heavy Veh. %	2	2	2	2	2	2
Cap. veh/h	183	1554	1230	33	756	730
Arrive On Green	0.10	0.85	0.85	0.35	0.00	0.48
Sat Flow (veh/h)	1781	3643	571	3534	96	1885
Grp Volume(v) veh/h	94	480	505	541	2	16
Grp Sat Flow(s) veh/h	1781	1777	1870	1777	1853	0
Q Serve(g.s) s	4.3	11.2	11.2	35.0	35.0	0.0
Cycle Q Clear(g.c) s	4.3	11.2	11.2	35.0	35.0	0.0
Prop In Lane	1.00	0.00	1.00	0.05	0.00	1.00
Lane Grp Cap(c) veh/h	183	758	798	55	619	645
v/c Ratio(x)	0.51	0.63	0.63	0.84	0.84	0.00
Avail Cap(c.a) veh/h	317	1196	1258	153	923	962
HCM Platoon Ratio	2.00	2.00	2.00	1.00	1.00	1.00
Upstream Filter(i)	0.94	0.94	0.94	1.00	1.00	1.00
Uniform Delay (d) s/veh	28.6	6.3	6.3	39.0	39.0	0.0
Incr Delay (d2) s/veh	2.1	0.8	0.8	4.5	4.3	0.0
Initial Q Delay(i3) s/veh	0.0	0.0	0.0	0.0	0.0	0.0
%ile BackQ(50%) veh/h	1.8	2.5	2.6	15.9	16.6	0.0
Unsig. Movement Delay, s/veh	30.7	7.1	7.1	43.5	43.3	0.0
LnGrp Delay(d) s/veh	C	A	A	D	A	A
LnGrp LOS	C	A	A	D	A	A
Approach Vol. veh/h	1079		1060			119
Approach Delay, s/veh	9.2		43.4			19.2
Approach LOS	A		D			B
Timer - Assigned Phs	2	4	6	7	8	
Phs Duration (G+Y+Rc) s	68.0	62.0	68.0	10.2	51.8	
Change Period (Y+Rc) s	6.0	6.5	6.0	4.0	6.5	
Max Green Setting (Gmax) s	30.0	87.5	30.0	16.0	67.5	
Max Q Clear Time (g_c+I1) s	2.1	13.2	6.7	6.3	37.0	
Green Ext Time (g_e) s	0.0	8.2	0.6	0.1	8.3	
Intersection Summary						
HCM 6th Ctrl Delay		25.8				C
HCM 6th LOS						

Smoke Tree Resort
2020 Background PM

3: Smoke Tree West & Lincoln Dr
HCM 6th TWSC

Intersection											
Int Delay, s/veh	0										
Movement	EBT	EBR	WBL	WBT	NBL	NBR					
Lane Configurations	↕	↕	↕	↕	↕	↕					
Traffic Vol, veh/h	902	1	0	953	0	0					
Future Vol, veh/h	902	1	0	953	0	0					
Conflicting Peds, #/hr	0	0	0	0	0	0					
Sign Control	Free	Free	Free	Free	Stop	Stop					
RT Channelized	-	None	-	None	-	None					
Storage Length	-	-	25	-	0	0					
Veh in Median Storage, #	0	-	-	0	0	-					
Grade, %	0	-	-	0	0	-					
Peak Hour Factor	90	90	90	90	90	90					
Heavy Vehicles, %	2	2	2	2	2	2					
Mvmt Flow	1002	1	0	1059	0	0					
Major/Minor	Major1	Major2	Minor1								
Conflicting Flow All	0	0	1003	0	1533	502					
Stage 1	-	-	-	1003	-	-					
Stage 2	-	-	-	-	530	-					
Critical Hdwy	-	-	4.14	-	6.84	6.94					
Critical Hdwy Stg 1	-	-	-	-	5.84	-					
Critical Hdwy Stg 2	-	-	-	-	5.84	-					
Follow-up Hdwy	-	-	2.22	-	3.52	3.32					
Pl Cap-1 Maneuver	-	-	686	-	107	515					
Stage 1	-	-	-	-	315	-					
Stage 2	-	-	-	-	555	-					
Platoon blocked, %	-	-	-	-	-	-					
Mov Cap-1 Maneuver	-	-	686	-	107	515					
Mov Cap-2 Maneuver	-	-	-	-	227	-					
Stage 1	-	-	-	-	315	-					
Stage 2	-	-	-	-	555	-					
Approach	EB	WB	NB								
HCM Control Delay, s	0	0	0								
HCM LOS				A							
Minor Lane/Major Mvmt	NBLn1	EBT	EBR	WBL	WBT						
Capacity (veh/h)	-	-	-	686	-						
HCM Lane V/C Ratio	-	-	-	-	-						
HCM Control Delay (s)	0	-	-	0	-						
HCM Lane LOS	A	-	-	A	-						
HCM 95th %tile Q(veh)	-	-	-	0	-						

Smoke Tree Resort
2020 Background PM

4: Smoke Tree East & Lincoln Dr
HCM 6th TWSC

Intersection											
Int Delay, s/veh	0										
Movement	EBT	EBR	WBL	WBT	NBL	NBR					
Lane Configurations	↕	↕	↕	↕	↕	↕					
Traffic Vol, veh/h	901	1	2	953	2	2					
Future Vol, veh/h	901	1	2	953	2	2					
Conflicting Peds, #/hr	0	0	0	0	0	0					
Sign Control	Free	Free	Free	Free	Stop	Stop					
RT Channelized	-	None	-	None	-	None					
Storage Length	-	-	25	-	0	0					
Veh in Median Storage, #	0	-	-	0	0	-					
Grade, %	0	-	-	0	0	-					
Peak Hour Factor	90	90	90	90	90	90					
Heavy Vehicles, %	2	2	2	2	2	2					
Mvmt Flow	1001	1	2	1059	2	2					
Major/Minor	Major1	Major2	Minor1								
Conflicting Flow All	0	0	1002	0	1536	501					
Stage 1	-	-	-	-	1002	-					
Stage 2	-	-	-	-	534	-					
Critical Hdwy	-	-	4.14	-	6.84	6.94					
Critical Hdwy Stg 1	-	-	-	-	5.84	-					
Critical Hdwy Stg 2	-	-	-	-	5.84	-					
Follow-up Hdwy	-	-	2.22	-	3.52	3.32					
Pl Cap-1 Maneuver	-	-	687	-	107	515					
Stage 1	-	-	-	-	316	-					
Stage 2	-	-	-	-	552	-					
Platoon blocked, %	-	-	-	-	-	-					
Mov Cap-1 Maneuver	-	-	687	-	107	515					
Mov Cap-2 Maneuver	-	-	-	-	227	-					
Stage 1	-	-	-	-	315	-					
Stage 2	-	-	-	-	552	-					
Approach	EB	WB	NB								
HCM Control Delay, s	0	0	0								
HCM LOS				C							
Minor Lane/Major Mvmt	NBLn1	EBT	EBR	WBL	WBT						
Capacity (veh/h)	315	-	-	687	-						
HCM Lane V/C Ratio	0.014	-	-	0.003	-						
HCM Control Delay (s)	16.6	-	-	10.3	-						
HCM Lane LOS	C	-	-	B	-						
HCM 95th %tile Q(veh)	0	-	-	0	-						

Smoke Tree Resort
2020 Background PM

5: Lincoln Medical West & Lincoln Dr
HCM 6th TWSC

Intersection	Init Delay, s/veh									
	0.7									
Movement	EBT	EBR	WBL	WBT	NBL	NBR				
Lane Configurations	↕	↕	↕	↕	↕	↕				
Traffic Vol, veh/h	896	7	21	925	30	26				
Future Vol, veh/h	896	7	21	925	30	26				
Conflicting Peds, #/hr	0	0	0	0	0	0				
Sign Control	Free	Free	Free	Free	Stop	Stop				
RT Channelized	-	None	-	None	-	None				
Storage Length	-	-	25	-	0	-				
Veh in Median Storage, #	0	-	-	0	0	-				
Grade, %	0	-	-	0	0	-				
Peak Hour Factor	90	90	90	90	90	90				
Heavy Vehicles, %	2	2	2	2	2	2				
Mvmt Flow	996	8	23	1028	33	29				
Major/Minor	Major1	Major2	Minor1							
Conflicting Flow All	0	0	1004	0	1560	502				
Stage 1	-	-	-	1000	-	-				
Stage 2	-	-	-	-	560	-				
Critical Hdwy	-	-	4.14	-	6.84	6.94				
Critical Hdwy Stg 1	-	-	-	-	5.84	-				
Critical Hdwy Stg 2	-	-	-	-	5.84	-				
Follow-up Hdwy	-	-	2.22	-	3.52	3.32				
Pl Cap-1 Maneuver	-	-	686	-	103	515				
Stage 1	-	-	-	-	317	-				
Stage 2	-	-	-	-	535	-				
Platoon blocked, %	-	-	-	-	-	-				
Mov Cap-1 Maneuver	-	-	686	-	99	515				
Mov Cap-2 Maneuver	-	-	-	-	216	-				
Stage 1	-	-	-	-	306	-				
Stage 2	-	-	-	-	535	-				
Approach	EB	WB	NB							
HCM Control Delay, s	0	0.2	20.4							
HCM LOS				C						
Minor Lane/Major Mvmt	NBLn1	EBT	EBR	WBL	WBT					
Capacity (veh/h)	296	-	-	686	-					
HCM Lane V/C Ratio	0.21	-	-	0.034	-					
HCM Control Delay (s)	20.4	-	-	10.4	-					
HCM Lane LOS	C	-	-	B	-					
HCM 95th %tile Q(veh)	0.8	-	-	0.1	-					

Smoke Tree Resort
2020 Background PM

6: Lincoln Medical East & Lincoln Dr
HCM 6th TWSC

Intersection	Init Delay, s/veh									
	0.2									
Movement	EBT	EBR	WBL	WBT	NBL	NBR				
Lane Configurations	↕	↕	↕	↕	↕	↕				
Traffic Vol, veh/h	918	4	0	945	2	30				
Future Vol, veh/h	918	4	0	945	2	30				
Conflicting Peds, #/hr	0	0	0	0	0	0				
Sign Control	Free	Free	Free	Free	Stop	Stop				
RT Channelized	-	None	-	None	-	None				
Storage Length	-	-	25	-	0	-				
Veh in Median Storage, #	0	-	-	0	0	-				
Grade, %	0	-	-	0	0	-				
Peak Hour Factor	90	90	90	90	90	90				
Heavy Vehicles, %	2	2	2	2	2	2				
Mvmt Flow	1020	4	0	1050	2	33				
Major/Minor	Major1	Major2	Minor1							
Conflicting Flow All	0	0	1024	0	1547	512				
Stage 1	-	-	-	1022	-	-				
Stage 2	-	-	-	-	525	-				
Critical Hdwy	-	-	4.14	-	6.84	6.94				
Critical Hdwy Stg 1	-	-	-	-	5.84	-				
Critical Hdwy Stg 2	-	-	-	-	5.84	-				
Follow-up Hdwy	-	-	2.22	-	3.52	3.32				
Pl Cap-1 Maneuver	-	-	674	-	105	507				
Stage 1	-	-	-	-	308	-				
Stage 2	-	-	-	-	558	-				
Platoon blocked, %	-	-	-	-	-	-				
Mov Cap-1 Maneuver	-	-	674	-	105	507				
Mov Cap-2 Maneuver	-	-	-	-	224	-				
Stage 1	-	-	-	-	308	-				
Stage 2	-	-	-	-	558	-				
Approach	EB	WB	NB							
HCM Control Delay, s	0	0	13.3							
HCM LOS				B						
Minor Lane/Major Mvmt	NBLn1	EBT	EBR	WBL	WBT					
Capacity (veh/h)	470	-	-	674	-					
HCM Lane V/C Ratio	0.076	-	-	0.076	-					
HCM Control Delay (s)	13.3	-	-	0	-					
HCM Lane LOS	B	-	-	A	-					
HCM 95th %tile Q(veh)	0.2	-	-	0	-					

Smoke Tree Resort
2020 Background PM

7: Apartment Drwy & Lincoln Dr
HCM 6th TWSC

Intersection																	
Init Delay, s/veh																	
13.1																	
Movement	EBL	EBT	EBR	WBL	WBT	WBR	NBL	NBT	NBR	SBL	SBT	SBR					
Lane Configurations	↔	↔	↔	↔	↔	↔	↔	↔	↔	↔	↔	↔	↔	↔	↔	↔	
Traffic Vol, veh/h	7	886	42	6	849	9	68	3	49	7	0	35					
Future Vol, veh/h	7	886	42	6	849	9	68	3	49	7	0	35					
Conflicting Peds, #/hr	0	0	0	0	0	0	0	0	0	0	0	0					
Sign Control	Free	Free	Free	Free	Free	Free	Free	Free	Free	Free	Free	Free	Free	Free	Free	Free	
RT Channelized	-	-	-	-	-	-	-	-	-	-	-	-	None	-	-	-	
Storage Length	25	-	-	25	-	-	-	-	-	-	-	0	-	-	-	0	
Veh in Median Storage, #	-	0	-	-	0	-	-	-	0	-	-	0	-	-	-	0	
Grade, %	-	0	-	-	0	-	-	-	0	-	-	0	-	-	-	0	
Peak Hour Factor	90	90	90	90	90	90	90	90	90	90	90	90					
Heavy Vehicles, %	2	2	2	2	2	2	2	2	2	2	2	2					
Mvmt Flow	8	984	47	7	943	10	76	3	54	8	0	39					
Major/Minor	Major1	Major2	Minor1	Minor2													
Conflicting Flow All	953	0	0	1031	0	0	1510	1991	516	1472	-	477					
Stage 1	-	-	-	-	-	-	1024	1024	-	962	-	-					
Stage 2	-	-	-	-	-	-	486	967	-	510	-	-					
Critical Hdwy	4:14	-	-	4:14	-	-	7:54	6:54	6:94	7:54	-	6:94					
Critical Hdwy Stg 1	-	-	-	-	-	-	6:54	5:54	-	6:54	-	-					
Critical Hdwy Stg 2	-	-	-	-	-	-	6:54	5:54	-	6:54	-	-					
Follow-up Hdwy	2:22	-	-	2:22	-	-	3:52	4:02	3:32	3:52	-	3:32					
Pot Cap-1 Maneuver	7:17	-	-	6:70	-	-	83	60	504	88	0	534					
Stage 1	-	-	-	-	-	-	252	311	-	275	0	-					
Stage 2	-	-	-	-	-	-	531	331	-	514	0	-					
Platoon blocked, %	-	-	-	-	-	-	-	-	-	-	-	-					
Mov Cap-1 Maneuver	7:17	-	-	6:70	-	-	76	59	504	74	-	534					
Mov Cap-2 Maneuver	-	-	-	-	-	-	76	59	-	74	-	-					
Stage 1	-	-	-	-	-	-	249	308	-	272	-	-					
Stage 2	-	-	-	-	-	-	487	328	-	448	-	-					
Approach	EB	WB	WB	EB	NB	SB											
HCM Control Delay, s	0.1	0.1	0.1	204.9	20.1	C											
HCM LOS	F	F	F	F	F	C											
Minor Lane/Major Mvmt	NBLn1	EBL	EBT	EBR	WBL	WBT	WBR	SBLn1	SBLn2								
Capacity (veh/h)	115	717	-	-	670	-	-	74	534								
HCM Lane V/C Ratio	1.159	0.011	-	-	0.01	-	-	0.105	0.073								
HCM Control Delay (s)	204.9	10.1	-	-	10.4	-	-	59.3	12.3								
HCM Lane LOS	F	B	-	-	B	-	-	F	B								
HCM 95th %ile Q(veh)	8.3	0	-	-	0	-	-	0.3	0.2								

Smoke Tree Resort
2020 Background PM

8: AJ's Drwy & Lincoln Dr
HCM 6th TWSC

Intersection																	
Init Delay, s/veh																	
2.4																	
Movement	EBL	EBT	EBR	WBL	WBT	WBR	NBL	NBT	NBR	SBL	SBT	SBR					
Lane Configurations	↔	↔	↔	↔	↔	↔	↔	↔	↔	↔	↔	↔	↔	↔	↔	↔	
Traffic Vol, veh/h	11	880	55	63	847	8	14	1	92	4	0	7					
Future Vol, veh/h	11	880	55	63	847	8	14	1	92	4	0	7					
Conflicting Peds, #/hr	0	0	0	0	0	0	0	0	0	0	0	0					
Sign Control	Free	Free	Free	Free	Free	Free	Free	Free	Free	Free	Free	Free	Free	Free	Free	Free	
RT Channelized	-	-	-	-	-	-	-	-	-	-	-	-	None	-	-	-	
Storage Length	25	-	-	25	-	-	-	-	-	-	-	0	-	-	-	0	
Veh in Median Storage, #	-	0	-	-	0	-	-	-	0	-	-	0	-	-	-	0	
Grade, %	-	0	-	-	0	-	-	-	0	-	-	0	-	-	-	0	
Peak Hour Factor	90	90	90	90	90	90	90	90	90	90	90	90					
Heavy Vehicles, %	2	2	2	2	2	2	2	2	2	2	2	2					
Mvmt Flow	12	978	61	70	941	9	16	1	102	4	0	8					
Major/Minor	Major1	Major2	Minor1	Minor2													
Conflicting Flow All	950	0	0	1039	0	0	1644	2123	520	1600	-	475					
Stage 1	-	-	-	-	-	-	1033	1033	-	1086	-	-					
Stage 2	-	-	-	-	-	-	611	1090	-	514	-	-					
Critical Hdwy	4:14	-	-	4:14	-	-	7:54	6:54	6:94	7:54	-	6:94					
Critical Hdwy Stg 1	-	-	-	-	-	-	6:54	5:54	-	6:54	-	-					
Critical Hdwy Stg 2	-	-	-	-	-	-	6:54	5:54	-	6:54	-	-					
Follow-up Hdwy	2:22	-	-	2:22	-	-	3:52	4:02	3:32	3:52	-	3:32					
Pot Cap-1 Maneuver	7:19	-	-	6:65	-	-	66	49	501	71	0	536					
Stage 1	-	-	-	-	-	-	249	308	-	231	0	-					
Stage 2	-	-	-	-	-	-	448	289	-	511	0	-					
Platoon blocked, %	-	-	-	-	-	-	-	-	-	-	-	-					
Mov Cap-1 Maneuver	7:19	-	-	6:65	-	-	59	43	501	50	-	536					
Mov Cap-2 Maneuver	-	-	-	-	-	-	59	43	-	50	-	-					
Stage 1	-	-	-	-	-	-	245	303	-	227	-	-					
Stage 2	-	-	-	-	-	-	395	259	-	398	-	-					
Approach	EB	WB	WB	EB	NB	SB											
HCM Control Delay, s	0.1	0.8	0.8	33.7	3.7	E											
HCM LOS	D	D	D	D	D	E											
Minor Lane/Major Mvmt	NBLn1	EBL	EBT	EBR	WBL	WBT	WBR	SBLn1	SBLn2								
Capacity (veh/h)	241	719	-	-	665	-	-	50	536								
HCM Lane V/C Ratio	0.493	0.017	-	-	0.105	-	-	0.089	0.015								
HCM Control Delay (s)	33.7	10.1	-	-	11	-	-	83.9	11.8								
HCM Lane LOS	D	B	-	-	B	-	-	F	B								
HCM 95th %ile Q(veh)	2.5	0.1	-	-	0.4	-	-	0.3	0								

Smoke Tree Resort
2020 Background PM

9: Scottsdale Rd & Lincoln Dr
Timings

	EBL	EBT	EBR	WBL	WBT	NBL	NBT	SBL	SBT	SBR	
Lane Group											
Lane Configurations	510	56	431	56	62	411	1624	61	1569	486	
Traffic Volume (vph)	510	56	431	56	62	411	1624	61	1569	486	
Future Volume (vph)	Split	NA	pm+ov	Split	NA	Prd	NA	Prd	NA	pm+ov	
Turn Type	4	4	5	8	8	5	2	1	6	4	
Protected Phases											
Permitted Phases	4	4	5	8	8	5	2	1	6	4	
Detector Phase											
Switch Phase											
Minimum Initial (s)	7.0	7.0	7.0	7.0	7.0	10.0	10.0	5.0	10.0	7.0	
Minimum Split (s)	13.0	13.0	13.0	13.0	13.0	13.0	16.7	11.0	16.0	13.0	
Total Split (s)	30.0	30.0	30.0	30.0	30.0	30.0	73.0	14.0	57.0	30.0	
Total Split (%)	23.1%	23.1%	23.1%	10.0%	10.0%	23.1%	56.2%	10.8%	43.8%	23.1%	
Yellow Time (s)	4.0	4.0	4.0	3.6	3.6	4.0	4.7	3.3	4.7	4.0	
All-Red Time (s)	1.5	1.5	1.5	2.0	2.0	1.5	1.0	2.0	1.0	1.5	
Lost Time Adjust (s)	0.0	0.0	0.0	0.0	0.0	0.0	0.0	0.0	0.0	0.0	
Total Lost Time (s)	5.5	5.5	5.5	5.6	5.6	5.5	5.7	5.3	5.7	5.5	
Lead/Lag											
Lead/Lag Optimize?	None	None	None	None	None	None	None	None	C-Max	None	
Recall Mode	24.5	24.5	45.7	7.3	7.3	21.2	70.4	7.9	54.6	84.8	
Act Effct Green (s)	0.19	0.19	0.35	0.06	0.06	0.16	0.54	0.06	0.42	0.65	
Actuated g/C Ratio	0.99	0.99	0.80	0.63	0.58	0.82	0.68	0.64	0.82	0.50	
v/c Ratio	100.1	100.6	33.0	86.8	37.9	64.6	23.7	85.4	37.6	11.3	
Control Delay	0.0	0.0	0.0	0.0	0.0	0.0	0.0	0.0	0.0	0.0	
Queue Delay	0.0	0.0	0.0	0.0	0.0	0.0	0.0	0.0	0.0	0.0	
Total Delay	F	F	C	F	D	E	C	F	D	B	
LOS	F	F	C	F	D	E	C	F	D	B	
Approach Delay											
Approach LOS	E	E	D	D	D	C	C	C	C	C	
Intersection Summary											
Cycle Length: 130											
Actuated Cycle Length: 130											
Offset: 0 (0%), Referenced to phase 6, SBT, Start of Green											
Natural Cycle: 90											
Control Type: Actuated-Coordinated											
Maximum v/c Ratio: 0.99											
Intersection Signal Delay: 40.3											
Intersection Capacity Utilization 82.1%											
Analysis Period (min) 15											

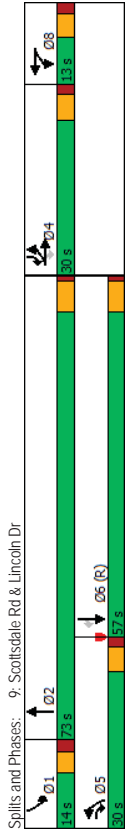

Smoke Tree Resort
2020 Background PM

9: Scottsdale Rd & Lincoln Dr
HCM 6th Signalized Intersection Summary

	EBL	EBT	EBR	WBL	WBT	NBL	NBT	SBL	SBT	SBR	
Movement											
Lane Configurations	510	56	431	56	62	411	1624	61	1569	486	
Traffic Volume (veh/h)	510	56	431	56	62	411	1624	45	61	1569	486
Future Volume (veh/h)	510	56	431	56	62	411	1624	45	61	1569	486
Initial Q (Ob), veh	0	0	0	0	0	0	0	0	0	0	0
Ped-Bike Adj(A_pbT)	1.00	1.00	1.00	1.00	1.00	1.00	1.00	1.00	1.00	1.00	1.00
Parking Bus, Adj	1.00	1.00	1.00	1.00	1.00	1.00	1.00	1.00	1.00	1.00	1.00
Work Zone On Approach	No	No	No	No	No	No	No	No	No	No	No
Adj Sat Flow, veh/h	1870	1870	1870	1870	1870	1870	1870	1870	1870	1870	1870
Adj Flow Rate, veh/h	611	0	479	62	69	80	457	1804	50	68	1743
Peak Hour Factor	0.90	0.90	0.90	0.90	0.90	0.90	0.90	0.90	0.90	0.90	0.90
Percent Heavy Veh, %	2	2	2	2	2	2	2	2	2	2	2
Cap, veh/h	671	0	535	101	101	90	515	2537	70	87	2015
Arrive On Green	0.06	0.00	0.06	0.06	0.06	0.06	0.15	0.50	0.50	0.05	0.39
Sat Flow, veh/h	3563	0	1585	1781	1777	1585	3456	5107	141	1781	5106
Grp Volume(v), veh/h	611	0	479	62	69	80	457	1202	652	68	1743
Grp Sat Flow(s),veh/h	1781	0	1585	1781	1777	1585	1728	1702	1845	1781	1702
Q Serve(g.s), s	22.2	0.0	24.5	4.4	5.0	6.5	16.9	35.7	35.8	4.9	40.8
Cycle O Clear(g.c), s	22.2	0.0	24.5	4.4	5.0	6.5	16.9	35.7	35.8	4.9	40.8
Prop In Lane	1.00	1.00	1.00	1.00	1.00	1.00	1.00	1.00	1.00	1.00	1.00
Lane Grp Cap(c), veh/h	671	0	535	101	101	90	515	1691	916	87	2015
V/C Ratio(X)	0.91	0.00	0.90	0.61	0.68	0.89	0.89	0.71	0.71	0.78	0.87
Avail Cap(c,a), veh/h	671	0	535	101	101	90	651	1762	955	119	2015
HCM Platoon Ratio	0.33	0.33	0.33	1.00	1.00	1.00	1.00	1.00	1.00	1.00	1.00
Upstream Filter()	1.00	0.00	1.00	1.00	1.00	1.00	1.00	1.00	1.00	1.00	1.00
Uniform Delay (d), s/veh	59.9	0.0	46.1	59.9	60.1	60.9	54.2	25.5	25.5	61.2	36.2
Incr Delay (d2), s/veh	16.2	0.0	17.0	7.6	14.4	57.9	10.3	1.1	2.0	13.9	5.3
Initial Q Delay(g3),s/veh	0.0	0.0	0.0	0.0	0.0	0.0	0.0	0.0	0.0	0.0	0.0
%ile Back(Q60%),veh/m	12.2	0.0	16.7	2.2	2.6	4.1	8.1	14.5	15.9	2.6	17.7
Unsig. Movement Delay, s/veh											
LnGrp Delay(d),s/veh	76.0	0.0	63.1	67.5	74.6	118.8	64.5	26.5	27.5	75.1	41.4
LnGrp LOS	E	A	E	E	E	F	E	C	C	E	D
Approach Vol, veh/h	1090										
Approach Delay, s/veh	70.4										
Approach LOS	E										
Timer - Assigned Phs	1	2	4	5	6	8					
Phs Duration (G+Y+Rc), s	11.6	70.3	30.0	24.9	57.0	13.0					
Change Period (Y+Rc), s	* 5.3	5.7	5.5	5.5	5.7	5.6					
Max Green Setting (Gmax), s	* 8.7	67.3	24.5	24.5	51.3	7.4					
Max Q Clear Time (g_c+I1), s	6.9	37.8	26.5	18.9	42.8	8.5					
Green EXT Time (g_ext), s	0.0	2.9	0.0	0.0	0.5	2.5					
Intersection Summary											
HCM 6th Ctrl Delay	44.1										
HCM 6th LOS	D										
Notes											
User approved pedestrian interval to be less than phase max green.											
User approved volume balancing among the lanes for turning movement.											
* HCM 6th computational engine requires equal clearance times for the phases crossing the barrier.											

Smoke Tree Resort
2020 Total AM

1: Mockingbird Ln & Lincoln Drive
Timings

	EBT	WBL	WBT	NBL	NBT	SBL	SBT
Lane Group	EBL	EBT	WBL	WBT	NBL	NBT	SBL
Lane Configurations	222	982	24	898	5	34	79
Traffic Volume (vph)	222	982	24	898	5	34	79
Future Volume (vph)	222	982	24	898	5	34	79
Turn Type	pm+pt	NA	Perm	NA	pm+pt	NA	NA
Protected Phases	1	6	2	2	4	3	8
Permitted Phases	6	6	2	2	4	4	8
Detector Phase							
Switch Phase							
Minimum Initial (s)	3.5	15.0	15.0	7.0	7.0	3.5	7.0
Minimum Split (s)	8.0	27.0	27.0	33.5	33.5	8.0	33.5
Total Split (s)	27.0	77.0	50.0	50.0	44.0	9.0	53.0
Total Split (%)	20.8%	59.2%	38.5%	38.5%	33.8%	6.9%	40.8%
Yellow Time (s)	3.0	4.5	4.5	4.0	4.0	3.0	4.0
All-Red Time (s)	1.0	1.5	1.5	2.5	2.5	1.0	2.5
Lost Time Adjust (s)	0.0	0.0	0.0	0.0	0.0	0.0	0.0
Total Lost Time (s)	4.0	6.0	6.0	6.5	6.5	4.0	6.5
Lead/Lag	Lead	Lag	Lag	Lag	Lag	Lead	Lead
Lead-Lag Optimize?	Yes	Yes	Yes	Yes	Yes	Yes	Yes
Recall Mode	None	C-Max	C-Max	None	None	None	None
Act Effct Green (s)	93.3	91.3	70.1	17.4	17.4	28.7	26.2
Actuated g/C Ratio	0.72	0.70	0.54	0.13	0.13	0.22	0.20
v/c Ratio	0.98	0.45	0.11	0.55	0.08	0.25	0.32
Control Delay	13.3	10.2	18.5	25.4	46.2	31.3	42.2
Queue Delay	0.0	0.0	0.0	0.0	0.0	0.0	0.0
Total Delay	13.3	10.2	18.5	25.4	46.2	31.3	42.2
LOS	B	B	C	D	C	D	D
Approach Delay	10.7	25.3	32.6	32.6	48.6		
Approach LOS	B	C	C	C	D	D	D
Intersection Summary							
Cycle Length: 130							
Actuated Cycle Length: 130							
Offset: 0 (0%), Referenced to phase 2:WBT and 6:EBTL, Start of Green							
Natural Cycle: 90							
Control Type: Actuated-Coordinated							
Maximum v/c Ratio: 0.84							
Intersection Signal Delay: 22.2							
Intersection Capacity Utilization 75.0%							
Analysis Period (min) 15							



Smoke Tree Resort
2020 Total AM

1: Mockingbird Ln & Lincoln Drive
HCM 6th Signalized Intersection Summary

	EBL	EBT	EBR	WBL	WBT	WBR	NBL	NBT	NBR	SBL	SBT	SBR
Movement	EBL	EBT	EBR	WBL	WBT	WBR	NBL	NBT	NBR	SBL	SBT	SBR
Lane Configurations	222	982	30	24	898	44	5	34	24	79	88	233
Traffic Volume (veh/h)	222	982	30	24	898	44	5	34	24	79	88	233
Future Volume (veh/h)	222	982	30	24	898	44	5	34	24	79	88	233
Initial Q (Obs.) veh	0	0	0	0	0	0	0	0	0	0	0	0
Ped-Bike Adj(A_pbT)	1.00	1.00	1.00	1.00	1.00	1.00	1.00	1.00	1.00	1.00	1.00	1.00
Parking Bus, Adj	No	No	No	No	No	No	No	No	No	No	No	No
Work Zone On Approach	No	No	No	No	No	No	No	No	No	No	No	No
Adj Sat Flow (veh/h)	1870	1870	1870	1870	1870	1870	1870	1870	1870	1870	1870	1870
Adj Flow Rate, veh/h	247	1091	33	27	998	49	6	38	27	88	98	259
Peak Hour Factor	0.90	0.90	0.90	0.90	0.90	0.90	0.90	0.90	0.90	0.90	0.90	0.90
Percent Heavy Veh. %	2	2	2	2	2	2	2	2	2	2	2	2
Cap. veh/h	394	2335	71	312	1915	94	88	175	124	310	109	289
Arrive On Green	0.08	0.66	0.66	0.56	0.56	0.56	0.17	0.17	0.17	0.04	0.24	0.24
Sat Flow, veh/h	1781	3522	107	501	3447	169	1024	1017	723	1781	454	1200
Grp Volume(v), veh/h	247	550	574	27	514	533	6	65	88	0	357	0
Grp Sat Flow(s),veh/h	1781	1777	1851	501	1777	1840	1024	0	1740	1781	0	1654
Q Serve(g.s), s	7.4	19.7	19.7	3.6	23.5	23.5	0.7	0.0	4.2	5.0	0.0	27.2
Cycle Q Clear(g.c), s	7.4	19.7	19.7	9.3	23.5	23.5	18.9	0.0	4.2	5.0	0.0	27.2
Prop In Lane	1.00	0.06	1.00	1.00	0.09	1.00	0.00	0.42	1.00	0.00	0.73	0.00
V/C Ratio(X)	0.63	0.47	0.47	0.09	0.52	0.52	0.07	0.00	0.22	0.28	0.00	0.90
Lane Grp Cap(c), veh/h	394	1178	1227	312	987	1022	88	0	299	310	0	398
Avail Cap(c.a), veh/h	572	1178	1227	312	987	1022	208	0	502	310	0	592
HCM Platoon Ratio	1.00	1.00	1.00	1.00	1.00	1.00	1.00	1.00	1.00	1.00	1.00	1.00
Upstream Filter(i)	1.00	1.00	1.00	0.55	0.55	0.55	1.00	0.00	1.00	1.00	0.00	1.00
Uniform Delay (d), s/veh	14.0	10.7	10.7	16.4	18.1	18.1	61.3	0.0	46.3	41.4	0.0	47.8
Incr Delay (d2), s/veh	1.6	1.3	1.3	0.3	1.1	1.0	0.3	0.0	0.4	0.5	0.0	11.7
Initial Q Delay(d3),s/veh	0.0	0.0	0.0	0.0	0.0	0.0	0.0	0.0	0.0	0.0	0.0	0.0
%ile BackQ(50%),veh/ln	3.0	7.9	8.2	0.4	9.8	10.2	0.2	0.0	1.9	2.4	0.0	12.5
Unsig. Movement Delay, s/veh	15.7	12.0	12.0	16.7	19.2	19.1	61.6	0.0	46.7	41.9	0.0	59.5
LnGrp Delay(d)s/veh	B	B	B	B	B	B	B	E	A	D	D	A
LnGrp LOS	B	B	B	B	B	B	B	E	A	D	D	A
Approach Vol. veh/h	1371			1074			71				445	
Approach Delay, s/veh	12.7			19.1			48.0				56.0	
Approach LOS	B			B			D				E	
Timer - Assigned Phs	1	2	3	4	6	8						
Phs Duration (G+Y+Rc), s	14.0	78.2	9.0	28.8	92.2	37.8						
Change Period (Y+Rc), s	4.0	6.0	4.0	6.5	6.0	6.5						
Max Green Setting (Gmax), s	23.0	44.0	5.0	37.5	71.0	46.5						
Max Q Clear Time (g_c+I1), s	9.4	25.5	7.0	20.9	21.7	29.2						
Green Ext Time (g_e), s	0.6	7.1	0.0	0.2	9.9	2.2						
Intersection Summary												
HCM 6th Ctrl Delay							22.4					
HCM 6th LOS							C					

Smoke Tree Resort
2020 Total AM

2: Quail Run Rd & Lincoln Drive
HCM 6th Signalized Intersection Summary

EBL	EBT	WBL	WBT	NBL	NBT	SBL	SBT
5	4	5	5	4	4	5	5
115	1031	862	862	2	2	0	26
115	1031	862	862	2	2	0	26
NA	Perm	NA	Perm	NA	Perm	NA	Perm
7	4	8	8	2	2	6	6
4	4	8	8	2	2	6	6
3.5	15.0	15.0	15.0	7.0	7.0	7.0	7.0
8.0	28.0	28.0	28.0	33.0	33.0	33.0	33.0
20.0	94.0	74.0	74.0	36.0	36.0	36.0	36.0
15.4%	72.3%	56.9%	56.9%	27.7%	27.7%	27.7%	27.7%
3.0	4.0	4.0	4.0	4.5	4.5	4.5	4.5
1.0	2.5	2.5	2.5	1.5	1.5	1.5	1.5
0.0	0.0	0.0	0.0	0.0	0.0	0.0	0.0
4.0	6.5	6.5	6.5	6.0	6.0	6.0	6.0
Yes	Yes	Yes	Yes	Yes	Yes	Yes	Yes
None	None	None	None	C-Max	C-Max	C-Max	C-Max
64.2	61.7	46.6	46.6	55.8	55.8	55.8	55.8
0.49	0.47	0.36	0.36	0.43	0.43	0.43	0.43
0.53	0.68	0.05	0.77	0.02	0.05	0.09	0.09
29.9	35.9	24.8	40.7	0.0	26.3	0.2	0.2
29.9	35.9	24.8	40.7	0.0	26.3	0.2	0.2
C	D	C	D	A	C	A	A
35.3	40.6	40.6	40.6	7.7	7.7	7.7	7.7
D	D	D	D	D	D	D	A
Intersection Summary							
Cycle Length: 130							
Actuated Cycle Length: 130							
Offset: 0 (0%), Referenced to phase 2:NBL and 6:SBTL, Start of Green							
Natural Cycle: 70							
Control Type: Actuated-Coordinated							
Maximum v/c Ratio: 0.77							
Intersection Signal Delay: 36.1							
Intersection Capacity Utilization 62.8%							
Analysis Period (min) 15							

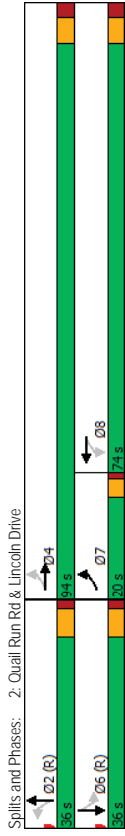

Smoke Tree Resort
2020 Total AM

2: Quail Run Rd & Lincoln Drive
HCM 6th Signalized Intersection Summary

EBL	EBT	WBL	WBT	NBL	NBT	SBL	SBT	SBR
5	4	5	5	4	4	5	5	5
115	1031	862	862	2	2	0	26	65
115	1031	862	862	2	2	0	26	65
0	0	0	0	0	0	0	0	0
1.00	1.00	1.00	1.00	1.00	1.00	1.00	1.00	1.00
No	No	No	No	No	No	No	No	No
1870	1870	1870	1870	1870	1870	1870	1870	1870
128	1146	4	6	958	13	2	0	29
0.90	0.90	0.90	0.90	0.90	0.90	0.90	0.90	0.90
2	2	2	2	2	2	2	2	2
210	1507	5	187	1152	16	138	21	632
0.13	0.83	0.83	0.32	0.32	0.32	0.49	0.00	0.49
1781	3632	13	489	3590	49	216	43	1291
128	561	589	6	474	497	12	0	29
1781	1777	1868	489	1777	1862	1550	0	1405
6.1	18.9	18.9	1.2	32.1	32.1	0.0	0.0	0.8
6.1	18.9	18.9	7.9	32.1	32.1	0.5	0.0	1.3
1.00	0.01	1.00	0.03	0.17	0.83	1.00	1.00	1.00
210	737	775	187	570	597	790	0	744
0.61	0.76	0.76	0.03	0.83	0.83	0.02	0.00	0.04
317	1196	1257	284	923	967	790	0	744
2.00	2.00	2.00	1.00	1.00	1.00	1.00	1.00	1.00
0.90	0.90	0.90	1.00	1.00	1.00	1.00	1.00	1.00
28.8	8.1	8.1	35.2	40.9	40.9	17.1	0.0	17.3
2.5	1.5	1.4	0.1	3.5	3.4	0.0	0.0	0.1
0.0	0.0	0.0	0.0	0.0	0.0	0.0	0.0	0.0
2.5	3.6	3.8	0.1	14.6	15.2	0.2	0.0	0.5
31.4	9.6	9.5	35.2	44.4	44.3	17.1	0.0	17.4
C	A	A	D	D	D	B	A	A
1278	11.7	977	44.3	12	17.1	101	17.8	17.8
2	4	6	7	8	8	8	8	8
69.6	60.4	69.6	12.2	48.2	48.2	6.5	6.5	6.5
30.0	87.5	30.0	16.0	67.5	67.5	5.2	8.1	34.1
2.5	20.9	20.9	0.4	0.2	0.2	7.6	7.6	7.6
0.0	10.5	10.5	0.4	0.2	0.2	7.6	7.6	7.6
Intersection Summary								
HCM 6th Ctrl Delay								
25.5								
C								

Smoke Tree Resort
2020 Total AM

3: Smoke Tree West & Lincoln Dr
HCM 6th TWSC

Intersection	Init Delay, s/veh									
	0									
Movement	EBT	EBR	WBL	WBT	NBL	NBR				
Lane Configurations	↔	↔	↔	↔	↔	↔				
Traffic Vol, veh/h	1056	10	0	875	0	6				
Future Vol, veh/h	1056	10	0	875	0	6				
Conflicting Peds, #/hr	0	0	0	0	0	0				
Sign Control	Free	Free	Free	Free	Stop	Stop				
RT Channelized	-	None	-	None	-	None				
Storage Length	-	-	-	-	-	0				
Veh in Median Storage, #	0	-	-	0	0	0				
Grade, %	0	-	-	0	0	-				
Peak Hour Factor	90	90	90	90	90	90				
Heavy Vehicles, %	2	2	2	2	2	2				
Mvmt Flow	1173	11	0	972	0	7				
Major/Minor	Major1	Major2	Minor1							
Conflicting Flow All	0	0	-	-	-	-	592			
Stage 1	-	-	-	-	-	-	-			
Stage 2	-	-	-	-	-	-	-			
Critical Hdwy	-	-	-	-	-	-	6.94			
Critical Hdwy Stg 1	-	-	-	-	-	-	-			
Critical Hdwy Stg 2	-	-	-	-	-	-	-			
Follow-up Hdwy	-	-	-	-	-	-	3.32			
Pl Cap-1 Maneuver	-	0	-	0	-	0	449			
Stage 1	-	0	-	0	-	0	-			
Stage 2	-	0	-	0	-	0	-			
Platoon blocked, %	-	-	-	-	-	-	-			
Mov Cap-1 Maneuver	-	-	-	-	-	-	449			
Mov Cap-2 Maneuver	-	-	-	-	-	-	-			
Stage 1	-	-	-	-	-	-	-			
Stage 2	-	-	-	-	-	-	-			
Approach	EB	WB	NB							
HCM Control Delay, s	0	0	13.1							
HCM LOS	B									
Minor Lane/Major Mvmt	NBLn1	EBT	EBR	WBL	WBT					
Capacity (veh/h)	449	-	-	-	-					
HCM Lane V/C Ratio	0.015	-	-	-	-					
HCM Control Delay (s)	13.1	-	-	-	-					
HCM Lane LOS	B	-	-	-	-					
HCM 95th %tile Q(veh)	0	-	-	-	-					

Smoke Tree Resort
2020 Total AM

4: Smoke Tree East & Lincoln Dr
HCM 6th TWSC

Intersection	Init Delay, s/veh									
	0.4									
Movement	EBT	EBR	WBL	WBT	NBL	NBR				
Lane Configurations	↔	↔	↔	↔	↔	↔				
Traffic Vol, veh/h	1057	7	27	863	14	14				
Future Vol, veh/h	1057	7	27	863	14	14				
Conflicting Peds, #/hr	0	0	0	0	0	0				
Sign Control	Free	Free	Free	Free	Stop	Stop				
RT Channelized	-	None	-	None	-	None				
Storage Length	-	-	25	-	0	-				
Veh in Median Storage, #	0	-	-	0	0	-				
Grade, %	0	-	-	0	0	-				
Peak Hour Factor	90	90	90	90	90	90				
Heavy Vehicles, %	2	2	2	2	2	2				
Mvmt Flow	1174	8	30	959	16	16				
Major/Minor	Major1	Major2	Minor1							
Conflicting Flow All	0	0	1182	0	1718	591				
Stage 1	-	-	-	-	-	1178				
Stage 2	-	-	-	-	-	540				
Critical Hdwy	-	-	4.14	-	6.84	6.94				
Critical Hdwy Stg 1	-	-	-	-	5.84	-				
Critical Hdwy Stg 2	-	-	-	-	5.84	-				
Follow-up Hdwy	-	-	2.22	-	3.52	3.32				
Pl Cap-1 Maneuver	-	-	587	-	81	450				
Stage 1	-	-	255	-	548	-				
Stage 2	-	-	-	-	-	-				
Platoon blocked, %	-	-	-	-	-	-				
Mov Cap-1 Maneuver	-	-	587	-	77	450				
Mov Cap-2 Maneuver	-	-	-	-	180	-				
Stage 1	-	-	-	-	242	-				
Stage 2	-	-	-	-	548	-				
Approach	EB	WB	NB							
HCM Control Delay, s	0	0.3	20.9							
HCM LOS	C									
Minor Lane/Major Mvmt	NBLn1	EBT	EBR	WBL	WBT					
Capacity (veh/h)	257	-	-	-	587					
HCM Lane V/C Ratio	0.121	-	-	-	0.051					
HCM Control Delay (s)	20.9	-	-	-	11.5					
HCM Lane LOS	C	-	-	-	B					
HCM 95th %tile Q(veh)	0.4	-	-	-	0.2					

Smoke Tree Resort
2020 Total AM

5: Lincoln Medical West & Lincoln Dr
HCM 6th TWSC

Intersection	Init Delay, s/veh									
	0.4									
Movement	EBT	EBR	WBL	WBT	NBL	NBR				
Lane Configurations	↔	↔	↔	↔	↔	↔				
Traffic Vol, veh/h	1054	17	47	883	6	9				
Future Vol, veh/h	1054	17	47	883	6	9				
Conflicting Peds, #/hr	0	0	0	0	0	0				
Sign Control	Free	Free	Free	Free	Stop	Stop				
RT Channelized	-	None	-	None	-	None				
Storage Length	-	-	25	-	0	-				
Veh in Median Storage, #	0	-	-	0	0	-				
Grade, %	0	-	-	-	0	0				
Peak Hour Factor	90	90	90	90	90	90				
Heavy Vehicles, %	2	2	2	2	2	2				
Mvmt Flow	1171	19	52	981	7	10				
Major/Minor	Major1	Major2	Minor1							
Conflicting Flow All	0	0	1190	0	1776	595				
Stage 1	-	-	-	-	1181	-				
Stage 2	-	-	-	-	595	-				
Critical Hdwy	-	-	4.14	-	6.84	6.94				
Critical Hdwy Stg 1	-	-	-	-	5.84	-				
Critical Hdwy Stg 2	-	-	-	-	5.84	-				
Follow-up Hdwy	-	-	2.22	-	3.52	3.32				
Pl Cap-1 Maneuver	-	-	582	-	74	447				
Stage 1	-	-	-	-	254	-				
Stage 2	-	-	-	-	514	-				
Platoon blocked, %	-	-	-	-	-	-				
Mov Cap-1 Maneuver	-	-	582	-	67	447				
Mov Cap-2 Maneuver	-	-	-	-	167	-				
Stage 1	-	-	-	-	231	-				
Stage 2	-	-	-	-	514	-				
Approach	EB	WB	NB							
HCM Control Delay, s	0	0.6	19.3							
HCM LOS	C									
Minor Lane/Major Mvmt	NBLn1	EBT	EBR	WBL	WBT					
Capacity (veh/h)	268	-	-	582	-					
HCM Lane V/C Ratio	0.062	-	-	0.09	-					
HCM Control Delay (s)	19.3	-	-	11.8	-					
HCM Lane LOS	C	-	-	B	-					
HCM 95th %ile Q(veh)	0.2	-	-	0.3	-					

Smoke Tree Resort
2020 Total AM

6: Lincoln Medical East & Lincoln Dr
HCM 6th TWSC

Intersection	Init Delay, s/veh									
	0.1									
Movement	EBT	EBR	WBL	WBT	NBL	NBR				
Lane Configurations	↔	↔	↔	↔	↔	↔				
Traffic Vol, veh/h	1050	11	0	930	0	9				
Future Vol, veh/h	1050	11	0	930	0	9				
Conflicting Peds, #/hr	0	0	0	0	0	0				
Sign Control	Free	Free	Free	Free	Stop	Stop				
RT Channelized	-	None	-	None	-	None				
Storage Length	-	-	-	-	-	0				
Veh in Median Storage, #	0	-	-	0	0	-				
Grade, %	0	-	-	-	0	0				
Peak Hour Factor	90	90	90	90	90	90				
Heavy Vehicles, %	2	2	2	2	2	2				
Mvmt Flow	1167	12	0	1033	0	10				
Major/Minor	Major1	Major2	Minor1							
Conflicting Flow All	0	0	-	-	-	590				
Stage 1	-	-	-	-	-	-				
Stage 2	-	-	-	-	-	-				
Critical Hdwy	-	-	-	-	-	6.94				
Critical Hdwy Stg 1	-	-	-	-	-	-				
Critical Hdwy Stg 2	-	-	-	-	-	-				
Follow-up Hdwy	-	-	-	-	-	3.32				
Pl Cap-1 Maneuver	-	-	0	-	0	451				
Stage 1	-	-	0	-	0	-				
Stage 2	-	-	0	-	0	-				
Platoon blocked, %	-	-	-	-	-	-				
Mov Cap-1 Maneuver	-	-	-	-	-	451				
Mov Cap-2 Maneuver	-	-	-	-	-	-				
Stage 1	-	-	-	-	-	-				
Stage 2	-	-	-	-	-	-				
Approach	EB	WB	NB							
HCM Control Delay, s	0	0	13.2							
HCM LOS	B									
Minor Lane/Major Mvmt	NBLn1	EBT	EBR	WBL	WBT					
Capacity (veh/h)	451	-	-	-	-					
HCM Lane V/C Ratio	0.022	-	-	-	-					
HCM Control Delay (s)	13.2	-	-	-	-					
HCM Lane LOS	B	-	-	-	-					
HCM 95th %ile Q(veh)	0.1	-	-	-	-					

Smoke Tree Resort
2020 Total AM

7: Apartment Drwy & Lincoln Dr
HCM 6th TWSC

Intersection													
Init Delay, s/veh													
10.4													
Movement	EBL	EBT	EBR	WBL	WBT	WBR	NBL	NBT	NBR	SBL	SBT	SBR	SBR
Lane Configurations	↔	↔	↔	↔	↔	↔	↔	↔	↔	↔	↔	↔	↔
Traffic Vol, veh/h	27	999	35	19	865	10	52	0	30	5	0	12	7
Future Vol, veh/h	27	999	35	19	865	10	52	0	30	5	0	12	7
Conflicting Peds, #/hr	0	0	0	0	0	0	0	0	0	0	0	0	0
Sign Control	Free	Free	Free	Free	Free	Free	Free	Free	Free	Free	Free	Free	Free
RT Channelized	-	-	-	-	-	-	-	-	-	-	-	-	-
Storage Length	25	-	-	25	-	-	-	-	-	-	-	-	-
Veh in Median Storage, #	-	0	-	-	0	-	-	-	-	-	-	-	-
Grade, %	-	0	-	-	0	-	-	-	-	-	-	-	-
Peak Hour Factor	90	90	90	90	90	90	90	90	90	90	90	90	90
Heavy Vehicles, %	2	2	2	2	2	2	2	2	2	2	2	2	2
Mvmt Flow	30	1110	39	21	961	11	58	0	33	6	0	13	13
Major/Minor	Major1	Major2	Minor1	Minor2									
Conflicting Flow All	972	0	0	1149	0	0	1713	2204	575	1624	-	486	-
Stage 1	-	-	-	-	-	-	-	-	-	-	-	-	-
Stage 2	-	-	-	-	-	-	-	-	-	-	-	-	-
Critical Hdwy	4.14	-	-	4.14	-	-	7.54	6.54	6.94	7.54	-	6.94	-
Critical Hdwy Stg 1	-	-	-	-	-	-	-	-	-	-	-	-	-
Critical Hdwy Stg 2	-	-	-	-	-	-	-	-	-	-	-	-	-
Follow-up Hdwy	2.22	-	-	2.22	-	-	3.52	4.02	3.32	3.52	-	3.32	-
Pot Cap-1 Maneuver	705	-	-	604	-	-	58	44	461	68	0	527	-
Stage 1	-	-	-	-	-	-	199	259	257	0	-	-	-
Stage 2	-	-	-	-	-	-	505	314	445	0	-	-	-
Platoon blocked, %	-	-	-	-	-	-	-	-	-	-	-	-	-
Mov Cap-1 Maneuver	705	-	-	604	-	-	-53	41	461	59	-	527	-
Mov Cap-2 Maneuver	-	-	-	-	-	-	-53	41	59	-	-	-	-
Stage 1	-	-	-	-	-	-	190	248	246	-	-	-	-
Stage 2	-	-	-	-	-	-	475	303	395	-	-	-	-
Approach	EB	WB	NB	SB									
HCM Control Delay, s	0.3	0.2	249.3	29.7									
HCM LOS	F	F	D	D									
Minor Lane/Major Mvmt	NBLn1	EBL	EBT	EBR	WBL	WBT	WBR	SBLn1	SBLn2				
Capacity (veh/h)	78	705	-	-	604	-	-	59	527				
HCM Lane V/C Ratio	1.168	0.043	-	-	0.035	-	-	0.094	0.025				
HCM Control Delay (s)	249.3	10.3	-	-	11.2	-	-	72.3	12				
HCM Lane LOS	F	B	-	-	B	-	-	F	B				
HCM 95th %ile Q(veh)	6.7	0.1	-	-	0.1	-	-	0.3	0.1				

Notes
- Volume exceeds capacity \$: Delay exceeds 300s +: Computation Not Defined *: All major volume in platoon

Smoke Tree Resort
2020 Total AM

8: AJ's Drwy & Lincoln Dr
HCM 6th TWSC

Intersection													
Init Delay, s/veh													
1													
Movement	EBL	EBT	EBR	WBL	WBT	WBR	NBL	NBT	NBR	SBL	SBT	SBR	SBR
Lane Configurations	↔	↔	↔	↔	↔	↔	↔	↔	↔	↔	↔	↔	↔
Traffic Vol, veh/h	3	978	55	44	877	8	6	0	42	4	1	12	7
Future Vol, veh/h	3	978	55	44	877	8	6	0	42	4	1	12	7
Conflicting Peds, #/hr	0	0	0	0	0	0	0	0	0	0	0	0	0
Sign Control	Free	Free	Free	Free	Free	Free	Free	Free	Free	Free	Free	Free	Free
RT Channelized	-	-	-	-	-	-	-	-	-	-	-	-	-
Storage Length	25	-	-	25	-	-	-	-	-	-	-	-	-
Veh in Median Storage, #	-	0	-	-	0	-	-	-	-	-	-	-	-
Grade, %	-	0	-	-	0	-	-	-	-	-	-	-	-
Peak Hour Factor	90	90	90	90	90	90	90	90	90	90	90	90	90
Heavy Vehicles, %	2	2	2	2	2	2	2	2	2	2	2	2	2
Mvmt Flow	3	1087	61	49	974	9	7	0	47	4	1	13	13
Major/Minor	Major1	Major2	Minor1	Minor2									
Conflicting Flow All	983	0	0	1148	0	0	1710	2205	574	1627	2231	492	-
Stage 1	-	-	-	-	-	-	-	-	-	-	-	-	-
Stage 2	-	-	-	-	-	-	-	-	-	-	-	-	-
Critical Hdwy	4.14	-	-	4.14	-	-	7.54	6.54	6.94	7.54	6.54	6.94	-
Critical Hdwy Stg 1	-	-	-	-	-	-	-	-	-	-	-	-	-
Critical Hdwy Stg 2	-	-	-	-	-	-	-	-	-	-	-	-	-
Follow-up Hdwy	2.22	-	-	2.22	-	-	3.52	4.02	3.32	3.52	4.02	3.32	-
Pot Cap-1 Maneuver	698	-	-	604	-	-	59	44	462	68	42	522	-
Stage 1	-	-	-	-	-	-	219	279	234	293	-	-	-
Stage 2	-	-	-	-	-	-	463	292	487	270	-	-	-
Platoon blocked, %	-	-	-	-	-	-	-	-	-	-	-	-	-
Mov Cap-1 Maneuver	698	-	-	604	-	-	53	40	462	57	38	522	-
Mov Cap-2 Maneuver	-	-	-	-	-	-	53	40	57	38	-	-	-
Stage 1	-	-	-	-	-	-	218	278	233	269	-	-	-
Stage 2	-	-	-	-	-	-	413	268	436	269	-	-	-
Approach	EB	WB	NB	SB									
HCM Control Delay, s	0	0.5	24.8	27.4									
HCM LOS	C	C	D	D									
Minor Lane/Major Mvmt	NBLn1	EBL	EBT	EBR	WBL	WBT	WBR	SBLn1	SBLn2				
Capacity (veh/h)	235	698	-	-	604	-	-	57	522				
HCM Lane V/C Ratio	0.227	0.005	-	-	0.081	-	-	0.078	0.026				
HCM Control Delay (s)	24.8	10.2	-	-	11.5	-	-	73.4	12.1				
HCM Lane LOS	C	B	-	-	B	-	-	F	B				
HCM 95th %ile Q(veh)	0.8	0	-	-	0.3	-	-	0.2	0.1				

Notes
- Volume exceeds capacity \$: Delay exceeds 300s +: Computation Not Defined *: All major volume in platoon

Smoke Tree Resort
2020 Total AM

9: Scottsdale Rd & Lincoln Dr
Timings

	EBL	EBT	EBR	WBL	WBT	NBL	NBT	SBL	SBT	SBR	
Lane Group											
Lane Configurations	4	4	4	4	4	4	4	4	4	4	
Traffic Volume (vph)	461	38	469	37	36	309	1316	51	1669	617	
Future Volume (vph)	461	38	469	37	36	309	1316	51	1669	617	
Turn Type	Split	NA	pm+ov	Split	NA	Prdt	NA	Prdt	NA	pm+ov	
Protected Phases	4	4	5	8	8	5	2	1	6	4	
Permitted Phases	4	4	5	8	8	5	2	1	6	4	
Detector Phase											
Switch Phase											
Minimum Initial (s)	7.0	7.0	7.0	7.0	7.0	10.0	10.0	5.0	10.0	7.0	
Minimum Split (s)	13.0	13.0	13.0	13.0	13.0	16.7	11.0	16.0	13.0	13.0	
Total Split (s)	30.0	30.0	30.0	30.0	30.0	73.0	14.0	57.0	30.0	30.0	
Total Split (%)	23.1%	23.1%	23.1%	10.0%	10.0%	23.1%	56.2%	10.8%	43.8%	23.1%	
Yellow Time (s)	4.0	4.0	4.0	3.6	3.6	4.0	4.7	3.3	4.7	4.0	
All-Red Time (s)	1.5	1.5	1.5	2.0	2.0	1.5	1.0	2.0	1.0	1.5	
Lost Time Adjust (s)	0.0	0.0	0.0	0.0	0.0	0.0	0.0	0.0	0.0	0.0	
Total Lost Time (s)	5.5	5.5	5.5	5.6	5.6	5.5	5.7	5.3	5.7	5.5	
Lead/Lag				Lead	Lead	Lag	Lag	Lead	Lag		
Lead-Lag Optimize?	None	None	None	None	None	None	None	None	C-Max	None	
Recall Mode	23.8	23.8	43.1	7.2	7.2	19.3	71.3	7.6	57.4	86.8	
Act Effct Green (s)	0.18	0.18	0.33	0.06	0.06	0.15	0.55	0.06	0.44	0.67	
Actuated g/C Ratio	0.90	0.90	0.91	0.42	0.40	0.67	0.54	0.55	0.83	0.61	
v/c Ratio	83.4	82.8	47.2	72.5	33.9	58.5	20.5	79.0	36.9	11.7	
Control Delay	0.0	0.0	0.0	0.0	0.0	0.0	0.0	0.0	0.0	0.0	
Queue Delay	83.4	82.8	47.2	72.5	33.9	58.5	20.5	79.0	36.9	11.7	
Total Delay	F	F	D	E	C	E	C	E	D	B	
LOS	E	E	E	D	D	D	C	C	C	C	
Approach Delay											
Approach LOS											
Intersection Summary											
Cycle Length: 130											
Actuated Cycle Length: 130											
Offset: 0 (0%), Referenced to phase 6, SBT, Start of Green											
Natural Cycle: 90											
Control Type: Actuated-Coordinated											
Maximum v/c Ratio: 0.91											
Intersection Signal Delay: 36.9											
Intersection Capacity Utilization 81.1%											
Analysis Period (min) 15											

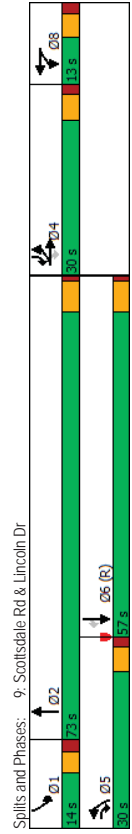

Smoke Tree Resort
2020 Total AM

9: Scottsdale Rd & Lincoln Dr
HCM 6th Signalized Intersection Summary

	EBL	EBT	EBR	WBL	WBT	NBL	NBT	SBL	SBT	SBR	
Movement											
Lane Configurations	4	4	4	4	4	4	4	4	4	4	
Traffic Volume (veh/h)	461	38	469	37	36	309	1316	51	1669	617	
Future Volume (veh/h)	461	38	469	37	36	309	1316	51	1669	617	
Initial Q (Ob), veh	0	0	0	0	0	0	0	0	0	0	
Ped-Bike Adj(A_pbT)	1.00	1.00	1.00	1.00	1.00	1.00	1.00	1.00	1.00	1.00	
Parking Bus, Adj	1.00	1.00	1.00	1.00	1.00	1.00	1.00	1.00	1.00	1.00	
Work Zone On Approach	No	No	No	No	No	No	No	No	No	No	
Adj Sat Flow, veh/h	1870	1870	1870	1870	1870	1870	1870	1870	1870	1870	
Adj Flow Rate, veh/h	542	0	521	41	40	53	343	976	529	57	1854
Peak Hour Factor	0.90	0.90	0.90	0.90	0.90	0.90	0.90	0.90	0.90	0.90	
Percent Heavy Veh, %	2	2	2	2	2	2	2	2	2	2	
Cap. veh/h	671	0	483	95	85	403	2404	71	73	2015	924
Arrive On Green	0.19	0.00	0.19	0.05	0.05	0.12	0.47	0.47	0.04	0.39	0.39
Sat Flow, veh/h	3563	0	1585	1781	1777	1585	3456	5098	150	1781	5106
Grp Volume(v), veh/h	542	0	521	41	40	53	343	976	529	57	1854
Grp Sat Flow(s),veh/h	1781	0	1585	1781	1777	1585	1728	1702	1843	1781	1702
Q Serve(g.s), s	18.9	0.0	24.5	2.9	2.8	4.3	12.7	27.6	27.6	4.1	44.9
Cycle O Clear(g.c), s	1.00	1.00	1.00	1.00	1.00	1.00	1.00	1.00	1.00	1.00	
Prop In Lane	1.00	1.00	1.00	1.00	1.00	1.00	1.00	1.00	1.00	1.00	
Lane Grp Cap(c), veh/h	671	0	483	95	85	403	1605	869	73	2015	924
V/C Ratio(X)	0.81	0.00	1.08	0.43	0.42	0.63	0.85	0.61	0.61	0.78	0.92
Avail Cap(c,a), veh/h	671	0	483	101	101	90	651	1762	954	119	2015
HCM Platoon Ratio	1.00	1.00	1.00	1.00	1.00	1.00	1.00	1.00	1.00	1.00	
Upstream Filter(0)	1.00	0.00	1.00	1.00	1.00	1.00	1.00	1.00	1.00	1.00	
Uniform Delay (d), veh/h	50.5	0.0	45.2	59.6	59.6	60.3	56.3	25.4	25.4	61.7	37.4
Incr Delay (d2), veh/h	6.7	0.0	63.4	1.1	1.1	8.2	3.2	0.3	0.6	6.5	8.4
Initial Q Delay(g3),s/veh	0.0	0.0	0.0	0.0	0.0	0.0	0.0	0.0	0.0	0.0	
%ile Back(Q3/60%) veh/h	9.1	0.0	24.0	1.3	1.3	1.9	5.7	11.1	12.1	2.0	20.0
Unsig. Movement Delay, s/veh	57.2	0.0	108.6	60.8	60.7	68.4	59.5	25.8	26.0	68.2	45.8
LnGrp Delay(d)s/veh	E	A	F	E	E	E	E	C	C	E	D
LnGrp LOS	E	A	F	E	E	E	E	C	C	E	D
Approach Vol, veh/h	1063			134			1848			2597	
Approach Delay, s/veh	82.4			63.8			32.1			40.8	
Approach LOS	F			E			C			D	
Timer - Assigned Phs	1	2	4	5	6	8					
Phs Duration (G+Y+Rc), s	10.6	67.0	30.0	20.7	57.0	12.5					
Change Period (Y+Rc), s	* 5.3	5.7	5.5	5.5	5.7	5.6					
Max Green Setting (Gmax), s	* 8.7	67.3	24.5	24.5	51.3	7.4					
Max Q Clear Time (g_c+I1), s	6.1	29.6	26.5	14.7	46.9	6.3					
Green EXT Time (g_e_c), s	0.0	2.2	0.0	0.5	1.9	0.0					
Intersection Summary											
HCM 6th Ctrl Delay	46.3										
HCM 6th LOS	D										
Notes											
User approved pedestrian interval to be less than phase max green.											
User approved volume balancing among the lanes for turning movement.											
* HCM 6th computational engine requires equal clearance times for the phases crossing the barrier.											

Smoke Tree Resort
2020 Total AM
HCM 6th TWSC

Smoke Tree Resort
2020 Total PM
Timings

Intersection	WBL	WBR	NBT	NBR	SBL	SBT
Initial Delay, s/veh	0					
Lane Configurations	W				4	
Traffic Vol. veh/h	0	4	0	0	4	0
Future Vol. veh/h	0	4	0	0	4	0
Conflicting Peds. #/hr	0	0	0	0	0	0
Sign Control	Stop	Stop	Free	Free	Free	Free
RT Channelized	-	None	-	None	-	None
Storage Length	0	-	0	-	0	-
Veh in Median Storage, #	0	-	0	-	0	-
Grade, %	0	-	0	-	0	-
Peak Hour Factor	90	90	90	90	90	90
Heavy Vehicles, %	2	2	2	2	2	2
Mgmt Flow	0	4	0	0	4	0
Major/Minor	Minor1	Major1	Major1	Major2		
Conflicting Flow All	8	0	0	0	0	0
Stage 1	0	-	-	-	-	-
Stage 2	8	-	-	-	-	-
Critical Hdwy	6.42	6.22	-	-	4.12	-
Critical Hdwy Stg 1	5.42	-	-	-	-	-
Critical Hdwy Stg 2	5.42	-	-	-	-	-
Follow-up Hdwy	3.518	3.318	-	-	2.218	-
Pl Cap-1 Maneuver	1013	-	-	-	-	-
Stage 1	-	-	-	-	-	-
Stage 2	1015	-	-	-	-	-
Platoon blocked, %	-	-	-	-	-	-
Mov Cap-1 Maneuver	1013	-	-	-	-	-
Mov Cap-2 Maneuver	1013	-	-	-	-	-
Stage 1	-	-	-	-	-	-
Stage 2	1015	-	-	-	-	-
Approach	WB	NB	SB	SB		
HCM Control Delay, s				0		
HCM LOS						
Minor Lane/Major Mvmt	NBT	NBR	WBL	N	SBL	SBT
Capacity (veh/h)	-	-	-	-	-	-
HCM Lane V/C Ratio	-	-	-	-	-	-
HCM Control Delay (s)	-	-	-	-	-	-
HCM Lane LOS	-	-	-	-	-	-
HCM 95th %ile Q(veh)	-	-	-	-	-	-

Smoke Tree Resort
2020 Total AM
HCM 6th TWSC

Smoke Tree Resort
2020 Total PM
Timings

Intersection	EBL	EBT	WBL	WBT	NBL	NBT	SBL	SBT
Lane Group	EBL	EBT	WBL	WBT	NBL	NBT	SBL	SBT
Lane Configurations	4	4	4	4	4	4	4	4
Traffic Volume (vph)	246	889	25	951	7	62	65	48
Future Volume (vph)	246	889	25	951	7	62	65	48
Turn Type	pm+pt	NA	Perm	NA	Perm	NA	pm+pt	NA
Protected Phases	1	6	2	2	4	4	3	8
Permitted Phases	1	6	2	2	4	4	3	8
Detector Phase								
Switch Phase								
Minimum Initial (s)	4.0	15.0	15.0	15.0	7.0	7.0	4.0	7.0
Minimum Split (s)	8.0	27.0	27.0	27.0	33.5	33.5	8.0	33.5
Total Split (s)	31.0	88.0	57.0	57.0	34.0	34.0	8.0	42.0
Total Spill (%)	23.8%	67.7%	43.8%	43.8%	26.2%	26.2%	6.2%	32.3%
Yellow Time (s)	3.0	4.5	4.5	4.5	4.0	4.0	3.0	4.0
All-Red Time (s)	1.0	1.5	1.5	1.5	2.5	2.5	1.0	2.5
Lost Time Adjust (s)	0.0	0.0	0.0	0.0	0.0	0.0	0.0	0.0
Total Lost Time (s)	4.0	6.0	6.0	6.0	6.5	6.5	4.0	6.5
Lead/Lag	Lead	Lag	Lag	Lag	Lag	Lag	Lead	Lead
Lead-Lag Optimize?	Yes	Yes	Yes	Yes	Yes	Yes	Yes	Yes
Recall Mode	None	C-Max	C-Max	C-Max	None	None	None	None
Act Effct Green (s)	101.8	99.8	77.6	77.6	11.3	11.3	20.2	17.7
Actuated g/C Ratio	0.78	0.77	0.60	0.60	0.09	0.09	0.16	0.14
v/c Ratio	0.60	0.38	0.09	0.54	0.10	0.55	0.41	0.68
Control Delay	11.6	5.9	14.4	24.4	55.3	61.8	53.9	33.6
Queue Delay	0.0	0.0	0.0	0.0	0.0	0.0	0.0	0.0
Total Delay	11.6	5.9	14.4	24.4	55.3	61.8	53.9	33.6
LOS	B	A	B	C	E	E	D	C
Approach Delay		7.1		24.1		61.2		38.5
Approach LOS		A		C		E		D
Intersection Summary								
Cycle Length: 130								
Actuated Cycle Length: 130								
Offset: 0 (0%), Referenced to phase 2:WBT and 6:EBTL, Start of Green								
Natural Cycle: 90								
Control Type: Actuated-Coordinated								
Maximum v/c Ratio: 0.68								
Intersection Signal Delay: 19.2								
Intersection Capacity Utilization: 67.9%								
Analysis Period (min): 15								

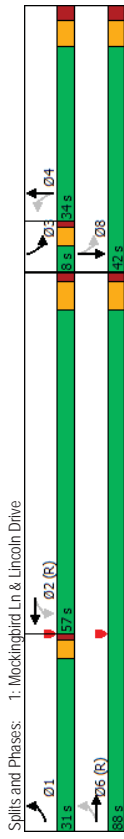

Smoke Tree Resort
2020 Total PM

1: Mockingbird Ln & Lincoln Drive
HCM 6th Signalized Intersection Summary

Movement	EBL	EBT	EBR	WBL	WBT	WBR	NBL	NBT	NBR	SBL	SBT	SBR
Lane Configurations	5	4	4	5	4	4	5	4	4	5	4	4
Traffic Volume (veh/h)	246	889	29	25	951	66	7	62	20	65	48	156
Future Volume (veh/h)	246	889	29	25	951	66	7	62	20	65	48	156
Initial Q (Q _{bb}), veh	0	0	0	0	0	0	0	0	0	0	0	0
Ped-Bike Adj(A, pb1)	1.00	1.00	1.00	1.00	1.00	1.00	1.00	1.00	1.00	1.00	1.00	1.00
Parking Bus, Adj	No	No	No	No	No	No	No	No	No	No	No	No
Work Zone On Approach	No	No	No	No	No	No	No	No	No	No	No	No
Adj Sat Flow, veh/hln	1870	1870	1870	1870	1870	1870	1870	1870	1870	1870	1870	1870
Adj Flow Rate, veh/h	273	988	32	28	1057	73	8	69	22	72	53	173
Peak Hour Factor	0.90	0.90	0.90	0.90	0.90	0.90	0.90	0.90	0.90	0.90	0.90	0.90
Percent Heavy Veh, %	2	2	2	2	2	2	2	2	2	2	2	2
Cap, veh/h	463	2617	85	411	2172	150	84	132	42	174	61	200
Arrive On Green	0.07	0.74	0.74	0.86	0.86	0.86	0.10	0.10	0.10	0.03	0.16	0.16
Sat Flow, veh/h	1781	3513	114	553	3372	233	1155	1359	433	1781	386	1258
Grp Sat Flow(s), veh/hln	1781	1777	1850	553	1777	1828	1155	0	1792	1781	0	226
Q Serve(g_s), s	6.4	13.0	13.0	1.0	10.0	10.0	0.9	0.0	6.3	4.0	0.0	17.4
Cycle O Clear(g_c), s	6.4	13.0	13.0	1.0	10.0	10.0	10.3	0.0	6.3	4.0	0.0	17.4
Prop In Lane	1.00	1.00	0.06	1.00	1.00	0.13	1.00	0.24	1.00	0.24	1.00	0.77
Lane Grp Cap(c), veh/h	463	1324	1378	411	1144	1178	84	0	175	174	0	261
V/C Ratio(x)	0.59	0.38	0.38	0.07	0.49	0.49	0.10	0.00	0.52	0.41	0.00	0.86
Avail Cap(c), veh/h	708	1324	1378	411	1144	1178	216	0	379	174	0	449
HCM Platoon Ratio	1.00	1.00	1.00	1.33	1.33	1.33	1.00	1.00	1.00	1.00	1.00	1.00
Upstream Filter(i)	1.00	1.00	1.00	0.55	0.55	0.55	1.00	0.00	1.00	1.00	0.00	1.00
Uniform Delay (d), s/veh	6.8	5.9	5.9	3.4	4.0	4.0	62.2	0.0	55.8	51.1	0.0	53.3
Incr Delay (d2), s/veh	1.2	0.8	0.8	0.2	0.8	0.8	0.5	0.0	2.4	1.6	0.0	8.6
Initial Q Delay(Q3), s/veh	0.0	0.0	0.0	0.0	0.0	0.0	0.0	0.0	0.0	0.0	0.0	0.0
%ile BackOfQ(50%), veh/h	2.4	4.7	4.9	0.1	2.8	2.9	0.3	0.0	3.0	0.4	0.0	7.8
Unsig. Movement Delay, s/veh												
LnGrp Delay(d), s/veh	8.1	6.7	6.7	3.6	4.9	4.8	62.7	0.0	58.2	52.6	0.0	61.9
LnGrp LOS	A	A	A	A	A	A	E	A	E	D	A	E
Approach Vol. veh/h	1293			1158			99				298	
Approach Delay, s/veh	7.0			4.8			58.5				59.6	
Approach LOS	A			A			E				E	
Timer - Assigned Phs	1	2	3	4	6	8						
Phs Duration (G+Y+Rc), s	13.1	89.7	8.0	19.2	102.8	27.2						
Change Period (Y+Rc), s	4.0	6.0	4.0	6.5	6.0	6.5						
Max Green Sailing (Gmax), s	27.0	51.0	4.0	27.5	82.0	35.5						
Max Q Clear Time (g_c+1t), s	8.4	12.0	6.0	12.3	15.0	19.4						
Green Ext Time (p_c), s	0.7	10.2	0.0	0.4	8.7	1.2						
Intersection Summary												
HCM 6th Ctrl Delay							13.4					
HCM 6th LOS							B					

Smoke Tree Resort
2020 Total PM

2: Quail Run Rd & Lincoln Drive
Timings

Lane Group	EBL	EBT	WBL	WBT	NBL	NBT	SBL	SBT
Lane Configurations	5	4	4	4	5	4	4	4
Traffic Volume (vph)	85	903	4	945	3	0	14	0
Future Volume (vph)	85	903	4	945	3	0	14	0
Turn Type	pm+pt	NA	Perm	NA	Perm	NA	Perm	NA
Protected Phases	7	4	8	8	2	2	6	6
Permitted Phases	4	4	8	8	2	2	6	6
Detector Phase	7	4	8	8	2	2	6	6
Switch Phase								
Minimum Initial (s)	3.5	15.0	15.0	15.0	7.0	7.0	7.0	7.0
Minimum Split (s)	8.0	28.0	28.0	28.0	33.0	33.0	33.0	33.0
Total Split (s)	20.0	94.0	74.0	74.0	36.0	36.0	36.0	36.0
Total Split (%)	15.4%	72.3%	56.9%	56.9%	27.7%	27.7%	27.7%	27.7%
Yellow Time (s)	3.0	4.0	4.0	4.0	4.5	4.5	4.5	4.5
All-Red Time (s)	1.0	2.5	2.5	2.5	1.5	1.5	1.5	1.5
Lost Time Adjust (s)	0.0	0.0	0.0	0.0	0.0	0.0	0.0	0.0
Total Lost Time (s)	4.0	6.5	6.5	6.5	6.0	6.0	6.0	6.0
Lead/Lag	Lead	Lag	Lag	Lag				
Lead-Lag Optimize?	Yes	Yes	Yes	Yes				
Recall Mode	None	None	None	None	C-Max	C-Max	C-Max	C-Max
Act Effct Green (s)	68.2	65.7	51.5	51.5	51.8	51.8	51.8	51.8
Actuated g/C Ratio	0.52	0.51	0.40	0.40	0.40	0.40	0.40	0.40
v/C Ratio	0.42	0.56	0.02	0.77	0.01	0.03	0.13	0.3
Control Delay	26.6	31.5	20.5	37.6	0.0	29.1	0.0	0.0
Queue Delay	0.0	0.0	0.0	0.0	0.0	0.0	0.0	0.0
Total Delay	26.6	31.5	20.5	37.6	0.0	29.1	0.0	0.0
LOS	C	C	C	D	A	C	A	A
Approach Delay								
Approach LOS								
Intersection Summary								
Cycle Length: 130								
Actuated Cycle Length: 130								
Offset: 0 (0%), Referenced to phase 2:NBT1 and 6:SBTL, Start of Green								
Natural Cycle: 70								
Control Type: Actuated-Coordinated								
Maximum v/C Ratio: 0.77								
Intersection Signal Delay: 32.6								
Intersection Capacity Utilization 59.2%								
Analysis Period (min) 15								

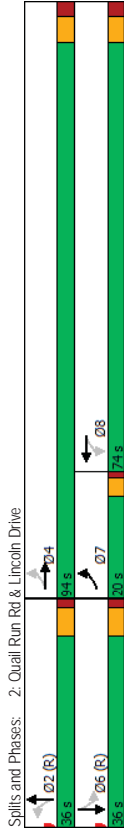

Smoke Tree Resort
2020 Total PM

2: Quail Run Rd & Lincoln Drive
HCM 6th Signalized Intersection Summary

	EBL	EBT	EBR	WBL	WBT	WBR	NBL	NBT	NBR	SBL	SBT	SBR
Movement												
Lane Configurations	5	4	4	4	4	4	3	3	0	6	14	0
Traffic Volume (veh/h)	85	903	3	4	945	25	3	0	6	14	0	93
Future Volume (veh/h)	85	903	3	4	945	25	3	0	6	14	0	93
Initial Q (Qb), veh	0	0	0	0	0	0	0	0	0	0	0	0
Ped-Bike Adj(A_pb1)	1.00	1.00	1.00	1.00	1.00	1.00	1.00	1.00	1.00	1.00	1.00	1.00
Parking Bus, Adj	1.00	1.00	1.00	1.00	1.00	1.00	1.00	1.00	1.00	1.00	1.00	1.00
Work Zone On Approach	No	No	No	No	No	No	No	No	No	No	No	No
Adj Sat Flow, veh/hln	1870	1870	1870	1870	1870	1870	1870	1870	1870	1870	1870	1870
Adj Flow Rate, veh/h	94	1003	3	4	1050	28	3	0	7	16	0	103
Peak Hour Factor	0.90	0.90	0.90	0.90	0.90	0.90	0.90	0.90	0.90	0.90	0.90	0.90
Percent Heavy Veh, %	2	2	2	2	2	2	2	2	2	2	2	2
Cap, veh/h	182	1570	5	251	1251	33	230	18	494	723	0	748
Arrive On Green	0.09	0.86	0.86	0.35	0.35	0.35	0.47	0.00	0.47	0.47	0.00	0.47
Sat Flow, veh/h	1781	3634	11	560	3536	94	411	38	1046	1409	0	1585
Grp Volume(v), veh/h	94	490	516	4	528	550	10	0	16	0	103	0
Grp Sat Flow(s),veh/hln	1781	1777	1868	560	1777	1863	1495	0	0	1409	0	1585
Q Serve(g_s), s	4.3	10.9	10.9	0.6	35.5	35.5	0.0	0.0	0.0	0.0	0.0	4.8
Cycle Q Clear(g_c), s	4.3	10.9	10.9	1.3	35.5	35.5	4.8	0.0	0.0	0.7	0.0	4.8
Prop In Lane	1.00	0.01	1.00	1.00	0.05	0.30	0.70	1.00	1.00	1.00	1.00	1.00
Lane Grp Cap(c), veh/h	182	768	807	251	629	656	741	0	0	723	0	748
V/C Ratio(X)	0.52	0.64	0.64	0.02	0.84	0.84	0.01	0.00	0.00	0.02	0.00	0.14
Avail Cap(c), veh/h	317	1196	1258	343	923	962	741	0	0	723	0	748
HCM Platoon Ratio	2.00	2.00	2.00	1.00	1.00	1.00	1.00	1.00	1.00	1.00	1.00	1.00
Upstream Filler(i)	0.93	0.93	0.93	1.00	1.00	1.00	1.00	0.00	0.00	1.00	0.00	1.00
Uniform Delay (d), s/veh	28.4	5.8	5.8	27.8	38.6	38.6	18.2	0.0	0.0	18.3	0.0	19.4
Incr Delay (d2), s/veh	2.1	0.8	0.8	0.0	4.6	4.4	0.0	0.0	0.0	0.1	0.0	0.4
Initial Q Delay(Q3),s/veh	0.0	0.0	0.0	0.0	0.0	0.0	0.0	0.0	0.0	0.0	0.0	0.0
%ile BackOf(50%),veh/h	1.8	2.4	2.5	0.1	16.1	16.8	0.2	0.0	0.0	0.3	0.0	1.9
Unsig. Movement Delay, s/veh												
LnGrp Delay(d)s/veh	30.5	6.6	6.5	27.8	43.2	43.0	18.3	0.0	0.0	18.4	0.0	19.8
LnGrp LOS	C	A	A	C	D	D	B	A	A	A	B	A
Approach Vol, veh/h	1100			1082			10					119
Approach Delay, s/veh	8.6			43.1			18.3					19.6
Approach LOS	A			D			B					B
Timer - Assigned PHS	2		4		6	7	8					
Phs Duration (G+Y+Rc), s	67.3		62.7		67.3	10.2	52.5					
Change Period (Y+Rc), s	6.0		6.5		6.0	4.0	6.5					
Max Green Sailing (Gmax), s	30.0		87.5		30.0	16.0	67.5					
Max Q Clear Time (g_c+1I), s	6.8		12.9		6.8	6.3	37.5					
Green Ext Time (p_c), s	0.0		8.5		0.6	0.1	8.5					
Intersection Summary												
HCM 6th Ctrl Delay												
HCM 6th LOS												

Smoke Tree Resort
2020 Total PM

3: Smoke Tree West & Lincoln Dr
HCM 6th TWSC

Intersection	EBT	EBR	WBT	WBR	NBT	NBR
Ini Delay, s/veh						0.1
Movement	EBT	EBR	WBT	WBR	NBT	NBR
Lane Configurations	4	4	4	4	4	4
Traffic Vol, veh/h	913	10	0	973	0	11
Future Vol, veh/h	913	10	0	973	0	11
Conflicting Peds, #/hr	0	0	0	0	0	0
Sign Control	Free	Free	Free	Free	Stop	Stop
RT Channelized	-	None	-	None	-	None
Storage Length	-	-	-	-	-	0
Veh in Median Storage, #	0	-	-	0	0	-
Grade, %	0	-	-	0	0	-
Peak Hour Factor	90	90	90	90	90	90
Heavy Vehicles, %	2	2	2	2	2	2
Mvmt Flow	1014	11	0	1081	0	12
Major/Minor	Major1	Major2	Minor1			
Conflicting Flow All	0	0	-	-	-	513
Stage 1	-	-	-	-	-	-
Stage 2	-	-	-	-	-	-
Critical Hdwy	-	-	-	-	-	6.94
Critical Hdwy Stg 1	-	-	-	-	-	-
Critical Hdwy Stg 2	-	-	-	-	-	-
Follow-up Hdwy	-	-	-	-	-	3.32
Pd Cap-1 Maneuver	-	0	-	0	-	506
Stage 1	-	0	-	0	-	-
Stage 2	-	0	-	0	-	-
Platoon blocked, %	-	-	-	-	-	-
Mov Cap-1 Maneuver	-	-	-	-	-	506
Mov Cap-2 Maneuver	-	-	-	-	-	-
Stage 1	-	-	-	-	-	-
Stage 2	-	-	-	-	-	-
Approach	EB	WB	NB			
HCM Control Delay, s	0	0	12.3			
HCM LOS			B			
Minor Lane/Major Mvmt	NBLn1	EBT	EBR	WBT		
Capacity (veh/h)	506	-	-	-	-	-
HCM Lane V/C Ratio	0.024	-	-	-	-	-
HCM Control Delay (s)	12.3	-	-	-	-	-
HCM Lane LOS	B	-	-	-	-	-
HCM 95th %tile Q(veh)	0.1	-	-	-	-	-

Smoke Tree Resort
2020 Total PM

4: Smoke Tree East & Lincoln Dr
HCM 6th TWSC

Intersection	0.6										
Int Delay, s/veh	EBT	EBR	WBL	WBT	NBL	NBR					
Movement	EBT	EBR	WBL	WBT	NBL	NBR					
Lane Configurations	↕	↕	↕	↕	↕	↕					
Traffic Vol, veh/h	915	9	34	957	18	23					
Future Vol, veh/h	915	9	34	957	18	23					
Conflicting Peds, #/hr	0	0	0	0	0	0					
Sign Control	Free	Free	Free	Free	Stop	Stop					
RT Channelized	-	None	-	None	-	None					
Storage Length	-	-	25	-	0	0					
Veh in Median Storage, #	0	-	-	0	0	-					
Grade, %	0	-	-	-	0	0					
Peak Hour Factor	90	90	90	90	90	90					
Heavy Vehicles, %	2	2	2	2	2	2					
Mvmt Flow	1017	10	38	1063	20	26					
Major/Minor	Major1	Major2	Minor1		Minor1						
Conflicting Flow All	0	0	1027	0	1630	514					
Stage 1	-	-	-	-	1022	-					
Stage 2	-	-	-	-	-	608					
Critical Hdwy	-	-	4.14	-	6.84	6.94					
Critical Hdwy Stg 1	-	-	-	-	5.84	-					
Critical Hdwy Stg 2	-	-	-	-	5.84	-					
Follow-up Hdwy	-	-	2.22	-	3.52	3.32					
Pl Cap-1 Maneuver	-	-	672	-	92	505					
Stage 1	-	-	-	-	308	-					
Stage 2	-	-	-	-	506	-					
Platoon blocked, %	-	-	-	-	-	-					
Mov Cap-1 Maneuver	-	-	672	-	87	505					
Mov Cap-2 Maneuver	-	-	-	-	200	-					
Stage 1	-	-	-	-	290	-					
Stage 2	-	-	-	-	506	-					
Approach	EB	WB	WB	NB	NB						
HCM Control Delay, s	0	0.4	0.4	19	19						
HCM LOS							C				
Minor Lane/Major Mvmt	NBLn1	EBT	EBR	WBL	WBT	WBT					
Capacity (veh/h)	302	-	-	672	-	-					
HCM Lane V/C Ratio	0.151	-	-	0.056	-	-					
HCM Control Delay (s)	19	-	-	10.7	-	-					
HCM Lane LOS	C	-	-	B	-	-					
HCM 95th %tile Q(veh)	0.5	-	-	0.2	-	-					

Smoke Tree Resort
2020 Total PM

5: Lincoln Medical West & Lincoln Dr
HCM 6th TWSC

Intersection	0.7										
Int Delay, s/veh	EBT	EBR	WBL	WBT	NBL	NBR					
Movement	EBT	EBR	WBL	WBT	NBL	NBR					
Lane Configurations	↕	↕	↕	↕	↕	↕					
Traffic Vol, veh/h	931	7	21	960	32	26					
Future Vol, veh/h	931	7	21	960	32	26					
Conflicting Peds, #/hr	0	0	0	0	0	0					
Sign Control	Free	Free	Free	Free	Stop	Stop					
RT Channelized	-	None	-	None	-	None					
Storage Length	-	-	25	-	0	0					
Veh in Median Storage, #	0	-	-	0	0	-					
Grade, %	0	-	-	-	0	0					
Peak Hour Factor	90	90	90	90	90	90					
Heavy Vehicles, %	2	2	2	2	2	2					
Mvmt Flow	1034	8	23	1067	36	29					
Major/Minor	Major1	Major2	Minor1		Minor1						
Conflicting Flow All	0	0	1042	0	1618	521					
Stage 1	-	-	-	-	1038	-					
Stage 2	-	-	-	-	-	580					
Critical Hdwy	-	-	4.14	-	6.84	6.94					
Critical Hdwy Stg 1	-	-	-	-	5.84	-					
Critical Hdwy Stg 2	-	-	-	-	5.84	-					
Follow-up Hdwy	-	-	2.22	-	3.52	3.32					
Pl Cap-1 Maneuver	-	-	663	-	94	500					
Stage 1	-	-	-	-	302	-					
Stage 2	-	-	-	-	523	-					
Platoon blocked, %	-	-	-	-	-	-					
Mov Cap-1 Maneuver	-	-	663	-	91	500					
Mov Cap-2 Maneuver	-	-	-	-	206	-					
Stage 1	-	-	-	-	291	-					
Stage 2	-	-	-	-	523	-					
Approach	EB	WB	WB	NB	NB						
HCM Control Delay, s	0	0.2	0.2	21.7	21.7						
HCM LOS							C				
Minor Lane/Major Mvmt	NBLn1	EBT	EBR	WBL	WBT	WBT					
Capacity (veh/h)	280	-	-	663	-	-					
HCM Lane V/C Ratio	0.23	-	-	0.035	-	-					
HCM Control Delay (s)	21.7	-	-	10.6	-	-					
HCM Lane LOS	C	-	-	B	-	-					
HCM 95th %tile Q(veh)	0.9	-	-	0.1	-	-					

Smoke Tree Resort
2020 Total PM

6: Lincoln Medical East & Lincoln Dr
HCM 6th TWSC

Intersection	Int Delay, s/veh	EBT	EBR	WBL	WBT	NBL	NBR								
Int Delay, s/veh	0.2														
Movement		EBT	EBR	WBL	WBT	NBL	NBR	SBL	SBT	SBR					
Lane Configurations		↑↑	↑↑	↑↑	↑↑	↑	↑	↑	↑	↑					
Traffic Vol, veh/h		953	4	0	980	0	30								
Future Vol, veh/h		953	4	0	980	0	30								
Conflicting Peds, #/hr		0	0	0	0	0	0								
Sign Control		Free	Free	Free	Free	Stop	Stop								
RT Channelized		-	None	-	None	-	None								
Storage Length		-	-	-	-	-	0								
Veh in Median Storage, #		0	-	-	0	0	-								
Grade, %		0	-	-	0	0	-								
Peak Hour Factor		90	90	90	90	90	90								
Heavy Vehicles, %		2	2	2	2	2	2								
Mvmt Flow		1059	4	0	1089	0	33								
Major/Minor		Major1	Major2	Minor1											
Conflicting Flow All		0	0	-	-	-	532								
Stage 1		-	-	-	-	-	-								
Stage 2		-	-	-	-	-	-								
Critical Hdwy		-	-	-	-	-	6.94								
Critical Hdwy Stg 1		-	-	-	-	-	-								
Critical Hdwy Stg 2		-	-	-	-	-	-								
Follow-up Hdwy		-	-	-	-	-	3.32								
Pl Cap-1 Maneuver		-	0	-	0	492									
Stage 1		-	0	-	0	-	-								
Stage 2		-	0	-	0	-	-								
Platoon blocked, %		-	-	-	-	-	-								
Mov Cap-1 Maneuver		-	-	-	-	-	492								
Mov Cap-2 Maneuver		-	-	-	-	-	-								
Stage 1		-	-	-	-	-	-								
Stage 2		-	-	-	-	-	-								
Approach		EB	WB	NB											
HCM Control Delay, s		0	0	12.8											
HCM LOS						B									
Minor Lane/Major Mvmt		NBLn1	EBT	EBR	WBT										
Capacity (veh/h)		492	-	-	-										
HCM Lane V/C Ratio		0.068	-	-	-										
HCM Control Delay (s)		12.8	-	-	-										
HCM Lane LOS		B	-	-	-										
HCM 95th %ile Q(veh)		0.2	-	-	-										

Smoke Tree Resort
2020 Total PM

7: Apartment Drwy & Lincoln Dr
HCM 6th TWSC

Intersection	Int Delay, s/veh	EBT	EBR	WBL	WBT	NBL	NBR	SBL	SBT	SBR			
Int Delay, s/veh	15.8												
Movement		EBT	EBR	WBL	WBT	NBL	NBR	SBL	SBT	SBR			
Lane Configurations		↑↑	↑↑	↑↑	↑↑	↑	↑	↑	↑	↑			
Traffic Vol, veh/h		7	921	42	6	884	9	68	3	49	7	0	
Future Vol, veh/h		7	921	42	6	884	9	68	3	49	7	0	
Conflicting Peds, #/hr		0	0	0	0	0	0	0	0	0	0	0	
Sign Control		Free	Free	Free	Free	Free	Free	Stop	Stop	Stop	Stop	Stop	
RT Channelized		-	None	-	None	-	None	-	None	-	None	-	
Storage Length		25	-	-	25	-	-	-	-	0	-	0	
Veh in Median Storage, #		0	-	-	0	-	-	-	-	0	-	0	
Grade, %		0	-	-	0	-	-	-	-	0	-	0	
Peak Hour Factor		90	90	90	90	90	90	90	90	90	90	90	
Heavy Vehicles, %		2	2	2	2	2	2	2	2	2	2	2	
Mvmt Flow		8	1023	47	7	982	10	76	3	54	8	0	
Major/Minor		Major1	Major2	Minor1	Minor2								
Conflicting Flow All		992	0	0	1070	0	0	1568	2069	535	1530	496	
Stage 1		-	-	-	-	-	-	1063	1063	-	1001	-	
Stage 2		-	-	-	-	-	-	505	1006	-	529	-	
Critical Hdwy		4.14	-	-	4.14	-	-	7.54	6.54	6.94	7.54	6.94	
Critical Hdwy Stg 1		-	-	-	-	-	-	6.54	5.54	-	6.54	-	
Critical Hdwy Stg 2		-	-	-	-	-	-	6.54	5.54	-	6.54	-	
Follow-up Hdwy		2.22	-	-	2.22	-	-	3.52	4.02	3.32	3.52	3.32	
Pl Cap-1 Maneuver		693	-	-	647	-	-	75	54	490	80	0	
Stage 1		-	-	-	-	-	-	238	298	-	260	0	
Stage 2		-	-	-	-	-	-	518	317	-	501	0	
Platoon blocked, %		-	-	-	-	-	-	-	-	-	-	-	
Mov Cap-1 Maneuver		693	-	-	647	-	-	-68	53	490	67	519	
Mov Cap-2 Maneuver		-	-	-	-	-	-	-68	53	-	67	-	
Stage 1		-	-	-	-	-	-	235	294	-	257	-	
Stage 2		-	-	-	-	-	-	474	314	-	435	-	
Approach		EB	WB	NB	SB								
HCM Control Delay, s		0.1	0.1	258	21.4								
HCM LOS						F C							
Minor Lane/Major Mvmt		NBLn1	EBL	EBT	EBR	WBL	WBT	WBR	SBLn1	SBLn2			
Capacity (veh/h)		104	693	-	-	647	-	-	67	519			
HCM Lane V/C Ratio		1.282	0.011	-	-	0.01	-	-	0.116	0.075			
HCM Control Delay (s)		258	10.3	-	-	10.6	-	-	65.7	12.5			
HCM Lane LOS		F	B	-	-	B	-	-	F	B			
HCM 95th %ile Q(veh)		9.1	0	-	-	0	-	-	0.4	0.2			

Smoke Tree Resort
2020 Total PM

8: AJ's Drwy & Lincoln Dr
HCM 6th TWSC

Intersection	2.6											
Init Delay, s/veh												
EBL	EBT	EBR	WBL	WBT	WBR	NBL	NBT	NBR	SBL	SBT	SBR	
11	915	55	63	882	8	14	1	92	4	0	7	
Future Vol, veh/h	11	915	55	63	882	8	14	1	92	4	0	7
Conflicting Peds, #/hr	0	0	0	0	0	0	0	0	0	0	0	0
Sign Control	Free	Free	Free	Free	Free	Free	Free	Free	Free	Free	Free	Free
RT Channelized	-	-	None	-	None	-	-	None	-	None	-	None
Storage Length	25	-	0	-	25	-	0	-	0	-	0	-
Veh in Median Storage, #	-	0	-	0	-	0	-	0	-	0	-	0
Grade, %	-	0	-	0	-	0	-	0	-	0	-	0
Peak Hour Factor	90	90	90	90	90	90	90	90	90	90	90	90
Heavy Vehicles, %	2	2	2	2	2	2	2	2	2	2	2	2
Mgmt Flow	12	1017	61	70	980	9	16	1	102	4	0	8
Major/Minor	Major1	Major2	Minor1	Minor2	Minor1	Minor2	Minor1	Minor2	Minor1	Minor2	Minor1	Minor2
Conflicting Flow All	989	0	0	1078	0	0	1702	2201	539	1658	-	495
Stage 1	-	-	-	-	-	-	1072	1072	-	1125	-	-
Stage 2	-	-	-	-	-	-	630	1129	-	533	-	-
Critical Hwy	4.14	-	-	4.14	-	-	7.54	6.54	6.94	7.54	-	6.94
Critical Hwy Slg 1	-	-	-	-	-	-	6.54	5.54	-	6.54	-	-
Critical Hwy Slg 2	-	-	-	-	-	-	6.54	5.54	-	6.54	-	-
Follow-up Hwy	2.22	-	-	2.22	-	-	3.52	4.02	3.32	3.52	-	3.32
Pl Cap-1 Maneuver	695	-	-	643	-	-	59	44	487	64	0	520
Stage 1	-	-	-	-	-	-	235	295	-	218	0	-
Stage 2	-	-	-	-	-	-	436	277	-	498	0	-
Platoon blocked, %	-	-	-	-	-	-	-	-	-	-	-	-
Mov Cap-1 Maneuver	695	-	-	643	-	-	53	39	487	45	-	520
Mov Cap-2 Maneuver	-	-	-	-	-	-	53	39	-	45	-	-
Stage 1	-	-	-	-	-	-	231	290	-	214	-	-
Stage 2	-	-	-	-	-	-	383	247	-	385	-	-
Approach	EB	WB	NB	WB	NB	SB	EB	WB	NB	WB	NB	SB
HCM Control Delay, s	0.1	0.7		37.9		41.7						
HCM LOS	E	E		E		E						
Minor Lane/Major Mvmt	NBLn1	EBL	EBT	EBR	WBL	WBT	WBR	SBLn1	SBLn2	SBLn2	SBLn2	SBR
Capacity (veh/h)	224	695	-	-	643	-	-	45	520	-	-	-
HCM Lane V/C Ratio	0.531	0.018	-	-	0.109	-	-	0.099	0.015	-	-	-
HCM Control Delay (s)	37.9	10.3	-	-	11.3	-	-	93.6	12	-	-	-
HCM Lane LOS	E	B	-	-	B	-	-	F	B	-	-	-
HCM 95th %ile Q(veh)	2.8	0.1	-	-	0.4	-	-	0.3	0	-	-	-

Smoke Tree Resort
2020 Total PM

9: Scottsdale Rd & Lincoln Dr
Timings

	EBL	EBT	EBR	WBL	WBT	WBR	NBL	NBT	NBR	SBL	SBT	SBR
Lane Group	EBL	EBT	EBR	WBL	WBT	WBR	NBL	NBT	NBR	SBL	SBT	SBR
Lane Configurations	529	56	447	56	62	427	1624	61	1569	505	505	505
Traffic Volume (vph)	529	56	447	56	62	427	1624	61	1569	505	505	505
Future Volume (vph)	Split	NA	pm+ov	Split	NA	Prot	NA	Prot	NA	pm+ov	NA	pm+ov
Turn Type	4	4	5	8	8	5	2	1	6	4	4	4
Protected Phases	4	4	5	8	8	5	2	1	6	4	4	4
Permitted Phases	4	4	5	8	8	5	2	1	6	4	4	4
Detector Phase	4	4	5	8	8	5	2	1	6	4	4	4
Switch Phase	4	4	5	8	8	5	2	1	6	4	4	4
Minimum Initial (s)	7.0	7.0	7.0	7.0	7.0	7.0	7.0	10.0	5.0	10.0	7.0	7.0
Minimum Split (s)	13.0	13.0	13.0	13.0	13.0	13.0	13.0	16.7	11.0	16.0	13.0	13.0
Total Split (s)	30.0	30.0	30.0	30.0	30.0	30.0	30.0	73.0	14.0	57.0	30.0	30.0
Total Split (%)	23.1%	23.1%	23.1%	10.0%	10.0%	23.1%	56.2%	10.8%	43.8%	23.1%	23.1%	23.1%
Yellow Time (s)	4.0	4.0	4.0	3.6	3.6	4.0	4.7	3.3	4.7	4.0	4.0	4.0
All-Red Time (s)	1.5	1.5	1.5	2.0	2.0	1.5	1.0	2.0	1.0	1.5	1.5	1.5
Lost Time Adjust (s)	0.0	0.0	0.0	0.0	0.0	0.0	0.0	0.0	0.0	0.0	0.0	0.0
Total Lost Time (s)	5.5	5.5	5.5	5.6	5.6	5.5	5.7	5.3	5.7	5.5	5.5	5.5
Lead/Lag	Lead	Lead	Lead	Lead	Lead	Lead	Lead	Lead	Lead	Lead	Lead	Lead
Lead-Lag Optimize?	None	None	None	None	None	None	None	None	None	None	None	None
Recall Mode	None	None	None	None	None	None	None	None	None	None	None	None
Act Effct Green (s)	24.5	24.5	46.1	7.3	7.3	21.6	70.4	7.9	54.3	84.5	84.5	84.5
Actuated g/C Ratio	0.19	0.19	0.35	0.06	0.06	0.17	0.54	0.06	0.42	0.65	0.65	0.65
v/C Ratio	1.02	1.02	0.82	0.63	0.63	0.88	0.83	0.68	0.64	0.82	0.82	0.82
Control Delay	108.1	107.7	35.0	86.8	86.8	37.9	65.6	23.7	85.4	38.0	11.8	11.8
Queue Delay	0.0	0.0	0.0	0.0	0.0	0.0	0.0	0.0	0.0	0.0	0.0	0.0
Total Delay	108.1	107.7	35.0	86.8	86.8	37.9	65.6	23.7	85.4	38.0	11.8	11.8
LOS	F	F	D	F	D	E	C	F	D	F	D	B
Approach Delay	76.3	76.3	52.2	32.3	32.3	33.2	33.2	33.2	33.2	33.2	33.2	33.2
Approach LOS	E	E	D	D	D	C	C	C	C	C	C	C
Intersection Summary												
Cycle Length: 130												
Actuated Cycle Length: 130												
Offset: 0 (0%), Referenced to phase 6:SBT, Start of Green												
Natural Cycle: 90												
Control Type: Actuated-Coordinated												
Maximum v/C Ratio: 1.02												
Intersection Signal Delay: 41.7												
Intersection Capacity Utilization: 83.0%												
Analysis Period (min): 15												

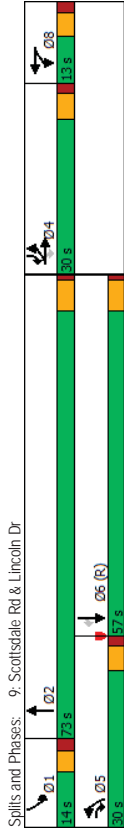

Smoke Tree Resort
2020 Total PM

9: Scottsdale Rd & Lincoln Dr
HCM 6th Signalized Intersection Summary

Smoke Tree Resort
2020 Total PM

10: Quail Run Rd & Access A
HCM 6th TWSC

Movement	EBL	EBT	EBR	WBL	WBT	WBR	NBL	NBT	NBR	SBL	SBT	SBR
Lane Configurations	5	5	5	5	5	5	5	5	5	5	5	5
Traffic Volume (veh/h)	529	56	447	56	62	72	427	1624	45	61	1569	505
Future Volume (veh/h)	529	56	447	56	62	72	427	1624	45	61	1569	505
Initial Q (Qsb), veh	0	0	0	0	0	0	0	0	0	0	0	0
Ped-Bike Adj(A_pb1)	1.00	1.00	1.00	1.00	1.00	1.00	1.00	1.00	1.00	1.00	1.00	1.00
Parking Bus, Adj	1.00	1.00	1.00	1.00	1.00	1.00	1.00	1.00	1.00	1.00	1.00	1.00
Work Zone On Approach	No	No	No	No	No	No	No	No	No	No	No	No
Adj Sat Flow, veh/h	1870	1870	1870	1870	1870	1870	1870	1870	1870	1870	1870	1870
Adj Flow Rate, veh/h	632	0	497	62	69	80	474	1804	50	68	1743	561
Peak Hour Factor	0.90	0.90	0.90	0.90	0.90	0.90	0.90	0.90	0.90	0.90	0.90	0.90
Percent Heavy Veh, %	2	2	2	2	2	2	2	2	2	2	2	2
Cap, veh/h	671	0	543	101	101	90	532	2561	71	87	2015	924
Arrive On Green	0.06	0.00	0.06	0.06	0.06	0.06	0.15	0.50	0.50	0.05	0.39	0.39
Sat Flow, veh/h	3563	0	1585	1781	1777	1585	3456	5107	141	1781	5106	1585
Grp Volume(v), veh/h	632	0	497	62	69	80	474	1202	652	68	1743	561
Grp Sat Flow(s), veh/h	1781	0	1585	1781	1777	1585	1728	1702	1845	1781	1702	1585
Q Serve(g.s), s	23.0	0.0	24.5	4.4	5.0	6.5	17.5	35.4	35.4	4.9	40.8	29.7
Cycle Q Clear(g.c), s	23.0	0.0	24.5	4.4	5.0	6.5	17.5	35.4	35.4	4.9	40.8	29.7
Prop In Lane	1.00	1.00	1.00	1.00	1.00	1.00	1.00	1.00	1.00	1.00	1.00	1.00
Lane Grp Cap(c), veh/h	671	0	543	101	101	90	532	1707	925	87	2015	924
V/C Ratio(x)	0.94	0.00	0.92	0.61	0.68	0.89	0.89	0.70	0.70	0.78	0.87	0.61
Avail Cap(c), veh/h	671	0	543	101	101	90	651	1762	955	119	2015	924
HCM Platoon Ratio	0.33	0.33	0.33	1.00	1.00	1.00	1.00	1.00	1.00	1.00	1.00	1.00
Upstream Filter(i)	1.00	0.00	1.00	1.00	1.00	1.00	1.00	1.00	1.00	1.00	1.00	1.00
Uniform Delay (d), s/veh	60.2	0.0	46.1	59.9	60.1	60.9	53.9	25.0	25.0	61.2	36.2	17.5
Incr Delay (d2), s/veh	21.3	0.0	20.0	7.6	14.4	57.9	11.3	1.0	1.9	13.9	5.3	3.0
Initial Q Delay(Q3), s/veh	13.0	0.0	17.7	2.2	2.6	4.1	8.4	14.3	15.7	2.6	17.7	17.2
%ile BackQ(50%),veh/m												
Unsig. Movement Delay, s/veh												
LnGrp Delay(d),s/veh	81.5	0.0	66.1	67.5	74.6	118.8	65.2	26.0	26.9	75.1	41.4	20.4
LnGrp LOS	F	A	E	E	E	F	E	C	C	E	D	C
Approach Vol, veh/h	1129			211			2328			2372		
Approach Delay, s/veh	74.7			89.3			34.2			37.4		
Approach LOS	E			F			C			D		
Timer - Assigned Phs	1	2	2	4	5	6	8					
Phs Duration (G+Y+Rc), s	11.6	70.9	30.0	25.5	57.0	13.0						
Change Period (Y+Rc), s	* 5.3	5.7	5.5	5.5	5.7	5.6						
Max Green Stalling (Gmax), s	* 8.7	67.3	24.5	24.5	51.3	7.4						
Max Q Clear Time (g_c+1t), s	6.9	37.4	26.5	19.5	42.8	8.5						
Green Ext Time (p_c), s	0.0	2.9	0.0	0.0	0.5	2.5	0.0					

Intersection Summary	EBL	EBT	EBR	WBL	WBT	WBR	NBL	NBT	NBR	SBL	SBT	SBR
HCM 6th Ctrl Delay												
HCM 6th LOS												
Notes	User approved pedestrian interval to be less than phase max green. User approved volume balancing among the lanes for turning movement. * HCM 6th computational engine requires equal clearance times for the phases crossing the barrier.											

Intersection	WBL	WBR	NBT	NBR	SBL	SBT
Initial Delay, s/veh	0	0	0	0	0	0
Movement	WBL	WBR	NBT	NBR	SBL	SBT
Lane Configurations	W	W	T	T	T	T
Traffic Vol, veh/h	0	6	0	0	5	0
Future Vol, veh/h	0	6	0	0	5	0
Conflicting Peds, #/hr	0	0	0	0	0	0
Sign Control	Stop	Stop	Free	Free	Free	Free
RT Channelized	-	None	-	None	-	None
Storage Length	0	-	-	-	-	-
Veh in Median Storage, #	0	-	0	-	-	0
Grade, %	0	-	0	-	-	0
Peak Hour Factor	90	90	90	90	90	90
Heavy Vehicles, %	2	2	2	2	2	2
Mvmt Flow	0	7	0	0	6	0
Major/Minor	Minor1	Major1	Major1	Major2		
Conflicting Flow All	12	0	0	0	0	0
Stage 1	0	-	-	-	-	-
Stage 2	12	-	-	-	-	-
Critical Hdwy	6.42	6.22	-	-	4.12	-
Critical Hdwy Stg 1	5.42	-	-	-	-	-
Critical Hdwy Stg 2	5.42	-	-	-	-	-
Follow-up Hdwy	3.518	3.318	-	-	2.218	-
Pl Cap-1 Maneuver	1008	-	-	-	-	-
Stage 1	-	-	-	-	-	-
Stage 2	1011	-	-	-	-	-
Platoon blocked, %	-	-	-	-	-	-
Mov Cap-1 Maneuver	1008	-	-	-	-	-
Mov Cap-2 Maneuver	1008	-	-	-	-	-
Stage 1	-	-	-	-	-	-
Stage 2	1011	-	-	-	-	-
Approach	WB	NB	SB			
HCM Control Delay, s	-	0				
HCM LOS						
Minor Lane/Major Mvmt	NBT	NBR/WB Ln1	SBL	SBT		
Capacity (veh/h)	-	-	-	-	-	-
HCM Lane V/C Ratio	-	-	-	-	-	-
HCM Control Delay (s)	-	-	-	-	-	-
HCM Lane LOS	-	-	-	-	-	-
HCM 95th %tile Q(veh)	-	-	-	-	-	-

APPENDIX H

2025 PEAK HOUR ANALYSIS

Smoke Tree Resort
2025 Background AM

1: Mockingbird Ln & Lincoln Drive
Timings

	EBL	EBT	WBL	WBT	NBL	NBT	SBL	SBT
Lane Group	EBL	EBT	WBL	WBT	NBL	NBT	SBL	SBT
Lane Configurations	242	1045	24	963	6	37	83	96
Traffic Volume (vph)	242	1045	24	963	6	37	83	96
Future Volume (vph)	pm-plt	NA	Perm	NA	Perm	NA	pm+pt	NA
Turn Type	1	6	2	2	4	4	3	8
Protected Phases	6	6	2	2	4	4	3	8
Permitted Phases	1	6	2	2	4	4	3	8
Detector Phase								
Switch Phase								
Minimum Initial (s)	3.5	15.0	15.0	15.0	7.0	7.0	3.5	7.0
Minimum Split (s)	8.0	27.0	27.0	27.0	33.5	33.5	8.0	33.5
Total Split (s)	27.0	77.0	50.0	50.0	44.0	44.0	9.0	53.0
Total Split (%)	20.8%	59.2%	38.5%	38.5%	33.8%	33.8%	6.9%	40.8%
Yellow Time (s)	3.0	4.5	4.5	4.5	4.0	4.0	3.0	4.0
All-Red Time (s)	1.0	1.5	1.5	1.5	2.5	2.5	1.0	2.5
Lost Time Adjust (s)	0.0	0.0	0.0	0.0	0.0	0.0	0.0	0.0
Total Lost Time (s)	4.0	6.0	6.0	6.0	6.5	6.5	4.0	6.5
Lead/Lag	Lead	Lag	Lag	Lag	Lag	Lag	Lead	Lead
Lead-Lag Optimize?	Yes	Yes	Yes	Yes	Yes	Yes	Yes	Yes
Recall Mode	None	C-Max	C-Max	C-Max	None	None	None	None
Act Effct Green (s)	90.6	88.6	65.5	65.5	19.6	19.6	31.4	28.9
Actuated g/C Ratio	0.70	0.68	0.50	0.50	0.15	0.15	0.24	0.22
v/c Ratio	0.66	0.50	0.12	0.63	0.09	0.23	0.30	0.85
Control Delay	21.5	12.0	22.8	30.5	44.3	30.9	39.7	50.6
Queue Delay	0.0	0.0	0.0	0.0	0.0	0.0	0.0	0.0
Total Delay	21.5	12.0	22.8	30.5	44.3	30.9	39.7	50.6
LOS	C	B	C	C	D	C	D	D
Approach Delay	13.7	30.3	30.3	32.1	32.1	32.1	48.5	48.5
Approach LOS	B	C	C	C	C	C	D	D
Intersection Summary								
Cycle Length: 130								
Actuated Cycle Length: 130								
Offset: 0 (0%), Referenced to phase 2:WBT and 6:EBTL, Start of Green								
Natural Cycle: 90								
Control Type: Actuated-Coordinated								
Maximum v/c Ratio: 0.85								
Intersection Signal Delay: 25.4								
Intersection Capacity Utilization 78.5%								
Analysis Period (min) 15								

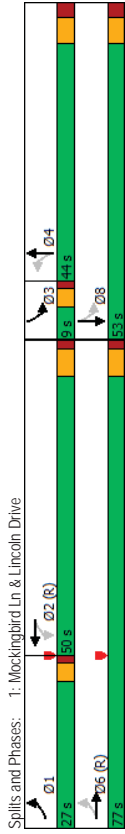

Smoke Tree Resort
2025 Background AM

1: Mockingbird Ln & Lincoln Drive
HCM 6th Signalized Intersection Summary

	EBL	EBT	EBR	WBL	WBT	WBR	NBL	NBT	NBR	SBL	SBT	SBR
Movement	EBL	EBT	EBR	WBL	WBT	WBR	NBL	NBT	NBR	SBL	SBT	SBR
Lane Configurations	242	1045	33	24	963	46	6	37	23	83	96	253
Traffic Volume (veh/h)	242	1045	33	24	963	46	6	37	23	83	96	253
Future Volume (veh/h)	0	0	0	0	0	0	0	0	0	0	0	0
Initial Q (Obs.) veh	1.00	1.00	1.00	1.00	1.00	1.00	1.00	1.00	1.00	1.00	1.00	1.00
Ped-Bike Adj(A_pbT)	No	No	No	No	No	No	No	No	No	No	No	No
Work Zone On Approach	1870	1870	1870	1870	1870	1870	1870	1870	1870	1870	1870	1870
Adj Sat Flow (veh/h)	269	1161	37	27	1070	51	7	41	26	92	107	281
Adj Flow Rate	0.90	0.90	0.90	0.90	0.90	0.90	0.90	0.90	0.90	0.90	0.90	0.90
Peak Hour Factor	2	2	2	2	2	2	2	2	2	2	2	2
Percent Heavy Veh. %	347	2365	72	274	1821	87	88	204	129	335	118	311
Cap. veh/h	0.09	0.64	0.64	0.35	0.35	0.35	0.19	0.19	0.19	0.04	0.26	0.26
Arrive On Green	1781	3515	112	467	3453	165	996	1070	678	1781	456	1198
Sat Flow (veh/h)	269	587	611	27	550	571	7	0	67	92	0	388
Grp Volume(v) veh/h	1781	1777	1850	467	1777	1841	996	0	1748	1781	0	1655
Grp Sat Flow(s) veh/h	8.6	22.8	22.8	5.4	32.9	32.9	0.9	0.0	4.2	5.0	0.0	29.5
Q Serve(g.s) s	8.6	22.8	22.8	13.0	32.9	32.9	21.4	0.0	4.2	5.0	0.0	29.5
Cycle Q Clear(g_c) s	1.00	0.06	1.00	1.00	0.09	1.00	0.09	1.00	0.39	1.00	0.72	1.00
Prop In Lane	347	1145	1192	274	937	971	88	0	333	335	0	429
Lane Grp Cap(c) veh/h	0.78	0.51	0.51	0.10	0.59	0.59	0.08	0.00	0.20	0.27	0.00	0.90
v/c Ratio(x)	508	1145	1192	274	937	971	186	0	504	335	0	592
Avail Cap(c_a) veh/h	1.00	1.00	1.00	0.67	0.67	0.67	1.00	1.00	1.00	1.00	1.00	1.00
HCM Platoon Ratio	1.00	1.00	1.00	0.55	0.55	0.55	1.00	1.00	1.00	1.00	1.00	1.00
Upstream Filter(i)	20.5	12.3	12.3	26.8	30.5	30.5	61.3	0.0	44.3	39.7	0.0	46.6
Uniform Delay (d) s/veh	4.5	1.6	1.6	0.4	1.5	1.4	0.4	0.0	0.3	0.4	0.0	13.7
Incr Delay (d2) s/veh	0.0	0.0	0.0	0.0	0.0	0.0	0.0	0.0	0.0	0.0	0.0	0.0
Initial Q Delay(g3) s/veh	4.4	9.2	9.6	0.7	15.3	15.8	0.2	0.0	1.9	2.4	0.0	13.7
%ile Back(Q50%) veh/h	25.0	13.9	13.9	27.2	32.0	31.9	61.6	0.0	44.6	40.1	0.0	60.3
Unsig. Movement Delay, s/veh	C	B	B	C	C	C	E	A	D	D	A	E
LnGrp Delay(d) s/veh	C	B	B	C	C	C	E	A	D	D	A	E
LnGrp LOS	C	B	B	C	C	C	E	A	D	D	A	E
Approach Vol. veh/h	1467	15.9	15.9	1148	31.8	31.8	74	46.2	56.4	56.4	480	480
Approach Delay, s/veh	B	B	B	C	C	C	D	D	D	D	E	E
Approach LOS	1	2	3	4	6	6	8					
Timer - Assigned Phs	15.2	74.6	9.0	31.2	89.8	40.2						
Phs Duration (G+Y+Rc) s	4.0	6.0	4.0	6.5	6.0	6.5						
Change Period (Y+Rc) s	23.0	44.0	5.0	37.5	71.0	46.5						
Max Green Setting (Gmax) s	10.6	34.9	7.0	23.4	24.8	31.5						
Max Q Clear Time (g_c+I1) s	0.6	5.0	0.0	0.2	10.9	2.2						
Green Ext Time (g_e) s												
Intersection Summary												
HCM 6th Ctrl Delay	28.5											
HCM 6th LOS	C											

Smoke Tree Resort
2025 Background AM

2: Quail Run Rd & Lincoln Drive
Timings

	EBL	EBT	WBL	WBT	NBT	SBL	SBT
Lane Group	EBL	EBT	WBL	WBT	NBT	SBL	SBT
Lane Configurations	115	1104	2	927	0	26	0
Traffic Volume (vph)	115	1104	2	927	0	26	0
Future Volume (vph)	pm-plt	NA	Perm	NA	NA	Perm	NA
Turn Type	7	4	8	8	2	6	6
Protected Phases	4	8	8	8	2	6	6
Permitted Phases	7	4	8	8	2	6	6
Detector Phase							
Switch Phase							
Minimum Initial (s)	3.5	15.0	15.0	15.0	7.0	7.0	7.0
Minimum Split (s)	8.0	28.0	28.0	33.0	33.0	33.0	33.0
Total Split (s)	20.0	94.0	74.0	74.0	36.0	36.0	36.0
Total Split (%)	15.4%	72.3%	56.9%	56.9%	27.7%	27.7%	27.7%
Yellow Time (s)	3.0	4.0	4.0	4.0	4.5	4.5	4.5
All-Red Time (s)	1.0	2.5	2.5	2.5	1.5	1.5	1.5
Lost Time Adjust (s)	0.0	0.0	0.0	0.0	0.0	0.0	0.0
Total Lost Time (s)	4.0	6.5	6.5	6.5	6.0	6.0	6.0
Lead/Lag	Lead	Lag	Lag	Lag	Lag	Lag	Lag
Lead-Lag Optimize?	Yes	Yes	Yes	Yes	Yes	Yes	Yes
Recall Mode	None	None	None	None	C-Max	C-Max	C-Max
Act Effct Green (s)	67.4	64.9	50.0	50.0	52.6	52.6	52.6
Actuated g/C Ratio	0.52	0.50	0.38	0.38	0.40	0.40	0.40
v/c Ratio	0.54	0.70	0.02	0.77	0.01	0.05	0.09
Control Delay	28.5	35.5	21.5	38.6	0.0	28.2	0.2
Queue Delay	0.0	0.0	0.0	0.0	0.0	0.0	0.0
Total Delay	28.5	35.5	21.5	38.6	0.0	28.2	0.2
LOS	C	D	C	D	A	C	A
Approach Delay	34.9			38.6		8.2	
Approach LOS	C	D	D	D	A	A	A

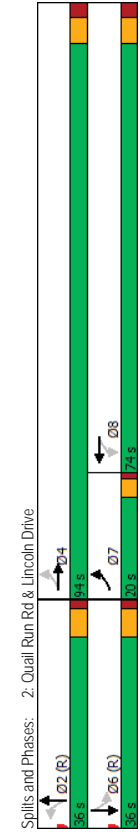

Smoke Tree Resort
2025 Background AM

2: Quail Run Rd & Lincoln Drive
HCM 6th Signalized Intersection Summary

	EBL	EBT	EBR	WBL	WBT	WBR	NBL	NBT	NBR	SBL	SBT	SBR
Movement	EBL	EBT	EBR	WBL	WBT	WBR	NBL	NBT	NBR	SBL	SBT	SBR
Lane Configurations	115	1104	3	2	927	12	0	0	8	26	0	66
Traffic Volume (veh/h)	115	1104	3	2	927	12	0	0	8	26	0	66
Future Volume (veh/h)	0	0	0	0	0	0	0	0	0	0	0	0
Initial Q (Obs.) veh	1.00	1.00	1.00	1.00	1.00	1.00	1.00	1.00	1.00	1.00	1.00	1.00
Ped-Bike Adj(A..pbT)	No	No	No	No	No	No	No	No	No	No	No	No
Work Zone On Approach	1870	1870	1870	1870	1870	1870	1870	1870	1870	1870	1870	1870
Adj Sat Flow, veh/h	128	1227	3	2	1030	13	0	0	9	29	0	73
Adj Flow Rate, veh/h	0.90	0.90	0.90	0.90	0.90	0.90	0.90	0.90	0.90	0.90	0.90	0.90
Peak Hour Factor	2	2	2	2	2	2	2	2	2	2	2	2
Percent Heavy Veh, %	208	1582	4	191	1231	16	0	0	743	710	0	743
Cap. veh/h	0.12	0.87	0.87	0.34	0.34	0.34	0.00	0.00	0.47	0.47	0.00	0.47
Arrive On Green	1781	3637	9	453	3594	45	0	0	1885	1406	0	1585
Sat Flow, veh/h	128	599	631	2	509	534	0	0	9	29	0	73
Grp Volume(v), veh/h	1781	1777	1869	453	1777	1862	0	0	1585	1406	0	1585
Grp Sat Flow(s), veh/h	5.9	17.6	17.6	0.4	34.3	34.3	0.0	0.0	0.4	1.5	0.0	3.3
Q Serve(g..s) s	5.9	17.6	17.6	5.9	34.3	34.3	0.0	0.0	0.4	1.9	0.0	3.3
Cycle Q Clear(g..c), s	1.00	1.00	1.00	1.00	1.00	1.00	0.02	0.00	1.00	1.00	0.00	1.00
Prop In Lane	208	773	813	191	609	638	0	0	743	710	0	743
VC Ratio(X)	0.62	0.78	0.78	0.01	0.84	0.84	0.00	0.00	0.01	0.04	0.00	0.10
Avail Cap(c..a), veh/h	317	1796	1258	271	923	967	0	0	743	710	0	743
HCM Platoon Ratio	2.00	2.00	2.00	1.00	1.00	1.00	1.00	1.00	1.00	1.00	1.00	1.00
Upstream Filter()	0.87	0.87	0.87	1.00	1.00	1.00	0.00	0.00	1.00	1.00	0.00	1.00
Uniform Delay (d), s/veh	28.2	5.9	5.9	32.0	39.4	39.4	0.0	0.0	18.4	18.9	0.0	19.2
Incr Delay (d2), s/veh	2.6	1.5	1.4	0.0	4.3	4.1	0.0	0.0	0.0	0.0	0.0	0.0
Initial Q Delay(d3), s/veh	0.0	0.0	0.0	0.0	0.0	0.0	0.0	0.0	0.0	0.0	0.0	0.0
%ile BackQ(50%), veh/h	2.5	2.9	3.1	0.0	15.6	16.3	0.0	0.0	0.2	0.5	0.0	1.3
Unsig. Movement Delay, s/veh	30.7	7.4	7.4	32.0	43.7	43.5	0.0	0.0	18.5	19.0	0.0	19.5
LnGrp Delay(d) s/veh	C	A	A	C	D	D	A	A	A	B	A	B
LnGrp LOS	C	A	A	C	D	D	A	A	A	B	A	B
Approach Vol, veh/h	1358			1045			9				102	
Approach Delay, s/veh	9.6			43.5			18.5				19.4	
Approach LOS	A			D			B				B	
Timer - Assigned Phs	2	4	4	6	7	8						
Phs Duration (G+Y+Rc), s	67.0	63.0	63.0	67.0	120	51.0						
Change Period (Y+Rc), s	6.0	6.5	6.5	6.0	4.0	6.5						
Max Green Setting (Gmax), s	30.0	87.5	87.5	30.0	16.0	67.5						
Max Q Clear Time (g_c+I1), s	2.4	19.6	19.6	5.3	7.9	36.3						
Green Ext Time (g_e), s	0.0	11.9	11.9	0.4	0.2	8.2						
Intersection Summary	24.1 C											
HCM 6th Ctrl Delay	C											

Smoke Tree Resort
2025 Background AM

3: Smoke Tree West & Lincoln Dr
HCM 6th TWSC

Intersection	Init Delay, s/veh										
	0										
Movement	EBT	EBR	WBL	WBT	NBL	NBR					
Lane Configurations	↕↔	↕↔	↕	↕↕	↕↕	↕↕					
Traffic Vol, veh/h	1135	2	0	937	0	0					
Future Vol, veh/h	1135	2	0	937	0	0					
Conflicting Peds, #/hr	0	0	0	0	0	0					
Sign Control	Free	Free	Free	Free	Stop	Stop					
RT Channelized	-	None	-	None	-	None					
Storage Length	-	-	25	-	0	-					
Veh in Median Storage, #	0	-	-	0	0	-					
Grade, %	0	-	-	0	0	-					
Peak Hour Factor	90	90	90	90	90	90					
Heavy Vehicles, %	2	2	2	2	2	2					
Mvmt Flow	1261	2	0	1041	0	0					
Major/Minor	Major1	Major2	Minor1								
Conflicting Flow All	0	0	1263	0	1783	632					
Stage 1	-	-	-	-	1263	-					
Stage 2	-	-	-	-	521	-					
Critical Hdwy	-	-	4.14	-	6.84	6.94					
Critical Hdwy Stg 1	-	-	-	-	5.84	-					
Critical Hdwy Stg 2	-	-	-	-	5.84	-					
Follow-up Hdwy	-	-	2.22	-	3.52	3.32					
Pl Cap-1 Maneuver	-	-	546	-	73	423					
Stage 1	-	-	-	-	230	-					
Stage 2	-	-	-	-	561	-					
Platoon blocked, %	-	-	-	-	-	-					
Mov Cap-1 Maneuver	-	-	546	-	73	423					
Mov Cap-2 Maneuver	-	-	-	-	175	-					
Stage 1	-	-	-	-	230	-					
Stage 2	-	-	-	-	561	-					
Approach	EB	WB	NB								
HCM Control Delay, s	0	0	0								
HCM LOS				A							
Minor Lane/Major Mvmt	NBLn1	EBT	EBR	WBL	WBT						
Capacity (veh/h)	-	-	-	-	546	-					
HCM Lane V/C Ratio	-	-	-	-	-	-					
HCM Control Delay (s)	0	-	-	-	0	-					
HCM Lane LOS	A	-	-	-	A	-					
HCM 95th %tile Q(veh)	-	-	-	-	0	-					

Smoke Tree Resort
2025 Background AM

4: Smoke Tree East & Lincoln Dr
HCM 6th TWSC

Intersection	Init Delay, s/veh										
	0.1										
Movement	EBT	EBR	WBL	WBT	NBL	NBR					
Lane Configurations	↕↔	↕↔	↕	↕↕	↕↕	↕↕					
Traffic Vol, veh/h	1137	0	1	934	6	2					
Future Vol, veh/h	1137	0	1	934	6	2					
Conflicting Peds, #/hr	0	0	0	0	0	0					
Sign Control	Free	Free	Free	Free	Stop	Stop					
RT Channelized	-	None	-	None	-	None					
Storage Length	-	-	25	-	0	-					
Veh in Median Storage, #	0	-	-	0	0	-					
Grade, %	0	-	-	0	0	-					
Peak Hour Factor	90	90	90	90	90	90					
Heavy Vehicles, %	2	2	2	2	2	2					
Mvmt Flow	1263	0	1	1038	7	2					
Major/Minor	Major1	Major2	Minor1								
Conflicting Flow All	0	0	1263	0	1784	632					
Stage 1	-	-	-	-	1263	-					
Stage 2	-	-	-	-	521	-					
Critical Hdwy	-	-	4.14	-	6.84	6.94					
Critical Hdwy Stg 1	-	-	-	-	5.84	-					
Critical Hdwy Stg 2	-	-	-	-	5.84	-					
Follow-up Hdwy	-	-	2.22	-	3.52	3.32					
Pl Cap-1 Maneuver	-	-	546	-	73	423					
Stage 1	-	-	-	-	230	-					
Stage 2	-	-	-	-	561	-					
Platoon blocked, %	-	-	-	-	-	-					
Mov Cap-1 Maneuver	-	-	546	-	73	423					
Mov Cap-2 Maneuver	-	-	-	-	175	-					
Stage 1	-	-	-	-	230	-					
Stage 2	-	-	-	-	561	-					
Approach	EB	WB	NB								
HCM Control Delay, s	0	0	0								
HCM LOS				C							
Minor Lane/Major Mvmt	NBLn1	EBT	EBR	WBL	WBT						
Capacity (veh/h)	205	-	-	-	546	-					
HCM Lane V/C Ratio	0.043	-	-	-	0.002	-					
HCM Control Delay (s)	23.4	-	-	-	11.6	-					
HCM Lane LOS	C	-	-	-	B	-					
HCM 95th %tile Q(veh)	0.1	-	-	-	0	-					

Smoke Tree Resort
2025 Background AM

5: Lincoln Medical West & Lincoln Dr
HCM 6th TWSC

Intersection	Init Delay, s/veh									
	0.4									
Movement	EBT	EBR	WBL	WBT	NBL	NBR				
Lane Configurations	↑↑	↑↑	↑	↑↑	↑	↑				
Traffic Vol, veh/h	1122	18	42	928	6	9				
Future Vol, veh/h	1122	18	42	928	6	9				
Conflicting Peds, #/hr	0	0	0	0	0	0				
Sign Control	Free	Free	Free	Free	Stop	Stop				
RT Channelized	-	None	-	None	-	None				
Storage Length	-	-	25	-	0	0				
Veh in Median Storage, #	0	-	-	0	0	-				
Grade, %	0	-	-	0	0	-				
Peak Hour Factor	90	90	90	90	90	90				
Heavy Vehicles, %	2	2	2	2	2	2				
Mvmt Flow	1247	20	47	1031	7	10				
Major/Minor	Major1	Major2	Minor1							
Conflicting Flow All	0	0	1267	0	1867	634				
Stage 1	-	-	-	-	1257	-				
Stage 2	-	-	-	-	610	-				
Critical Hdwy	-	-	4.14	-	6.84	6.94				
Critical Hdwy Stg 1	-	-	-	-	5.84	-				
Critical Hdwy Stg 2	-	-	-	-	5.84	-				
Follow-up Hdwy	-	-	2.22	-	3.52	3.32				
Pl Cap-1 Maneuver	-	-	544	-	64	422				
Stage 1	-	-	-	-	231	-				
Stage 2	-	-	-	-	505	-				
Platoon blocked, %	-	-	-	-	-	-				
Mov Cap-1 Maneuver	-	-	544	-	58	422				
Mov Cap-2 Maneuver	-	-	-	-	154	-				
Stage 1	-	-	-	-	211	-				
Stage 2	-	-	-	-	505	-				
Approach	EB	WB	NB							
HCM Control Delay, s	0	0.5	20.5							
HCM LOS							C			
Minor Lane/Major Mvmt	NBLn1	EBT	EBR	WBL	WBT					
Capacity (veh/h)	249	-	-	544	-					
HCM Lane V/C Ratio	0.067	-	-	0.086	-					
HCM Control Delay (s)	20.5	-	-	12.2	-					
HCM Lane LOS	C	-	-	B	-					
HCM 95th %ile Q(veh)	0.2	-	-	0.3	-					

Smoke Tree Resort
2025 Background AM

6: Lincoln Medical East & Lincoln Dr
HCM 6th TWSC

Intersection	Init Delay, s/veh									
	0.1									
Movement	EBT	EBR	WBL	WBT	NBL	NBR				
Lane Configurations	↑↑	↑↑	↑	↑↑	↑	↑				
Traffic Vol, veh/h	1118	11	6	970	0	9				
Future Vol, veh/h	1118	11	6	970	0	9				
Conflicting Peds, #/hr	0	0	0	0	0	0				
Sign Control	Free	Free	Free	Free	Stop	Stop				
RT Channelized	-	None	-	None	-	None				
Storage Length	-	-	25	-	0	0				
Veh in Median Storage, #	0	-	-	0	0	-				
Grade, %	0	-	-	0	0	-				
Peak Hour Factor	90	90	90	90	90	90				
Heavy Vehicles, %	2	2	2	2	2	2				
Mvmt Flow	1242	12	7	1078	0	10				
Major/Minor	Major1	Major2	Minor1							
Conflicting Flow All	0	0	1254	0	1801	627				
Stage 1	-	-	-	-	1248	-				
Stage 2	-	-	-	-	553	-				
Critical Hdwy	-	-	4.14	-	6.84	6.94				
Critical Hdwy Stg 1	-	-	-	-	5.84	-				
Critical Hdwy Stg 2	-	-	-	-	5.84	-				
Follow-up Hdwy	-	-	2.22	-	3.52	3.32				
Pl Cap-1 Maneuver	-	-	551	-	71	426				
Stage 1	-	-	-	-	234	-				
Stage 2	-	-	-	-	540	-				
Platoon blocked, %	-	-	-	-	-	-				
Mov Cap-1 Maneuver	-	-	551	-	70	426				
Mov Cap-2 Maneuver	-	-	-	-	173	-				
Stage 1	-	-	-	-	231	-				
Stage 2	-	-	-	-	540	-				
Approach	EB	WB	NB							
HCM Control Delay, s	0	0.1	13.7							
HCM LOS							B			
Minor Lane/Major Mvmt	NBLn1	EBT	EBR	WBL	WBT					
Capacity (veh/h)	426	-	-	551	-					
HCM Lane V/C Ratio	0.023	-	-	0.012	-					
HCM Control Delay (s)	13.7	-	-	11.6	-					
HCM Lane LOS	B	-	-	B	-					
HCM 95th %ile Q(veh)	0.1	-	-	0	-					

Smoke Tree Resort
2025 Background AM

7: Apartment Drwy & Lincoln Dr
HCM 6th TWSC

8: AJ's Drwy & Lincoln Dr
HCM 6th TWSC

Intersection													
Init Delay, s/veh													
16.7													
Movement	EBL	EBT	EBR	WBL	WBT	WBR	NBL	NBT	NBR	SBL	SBT	SBR	SBR
Lane Configurations	↔	↔	↔	↔	↔	↔	↔	↔	↔	↔	↔	↔	↔
Traffic Vol, veh/h	29	1062	38	20	905	11	56	0	33	6	0	14	7
Future Vol, veh/h	29	1062	38	20	905	11	56	0	33	6	0	14	7
Conflicting Peds, #/hr	0	0	0	0	0	0	0	0	0	0	0	0	0
Sign Control	Free	Free	Free	Free	Free	Free	Free	Free	Free	Free	Free	Free	Free
RT Channelized	-	-	-	-	-	-	-	-	-	-	-	-	-
Storage Length	25	-	-	25	-	-	-	-	-	-	-	-	-
Veh in Median Storage, #	-	0	-	-	0	-	-	-	-	-	-	-	-
Grade, %	-	0	-	-	0	-	-	-	-	-	-	-	-
Peak Hour Factor	90	90	90	90	90	90	90	90	90	90	90	90	90
Heavy Vehicles, %	2	2	2	2	2	2	2	2	2	2	2	2	2
Mvmt Flow	32	1180	42	22	1006	12	62	0	37	7	0	16	16

Intersection													
Init Delay, s/veh													
1.3													
Movement	EBL	EBT	EBR	WBL	WBT	WBR	NBL	NBT	NBR	SBL	SBT	SBR	SBR
Lane Configurations	↔	↔	↔	↔	↔	↔	↔	↔	↔	↔	↔	↔	↔
Traffic Vol, veh/h	3	1040	60	48	918	9	7	0	46	5	1	14	7
Future Vol, veh/h	3	1040	60	48	918	9	7	0	46	5	1	14	7
Conflicting Peds, #/hr	0	0	0	0	0	0	0	0	0	0	0	0	0
Sign Control	Free	Free	Free	Free	Free	Free	Free	Free	Free	Free	Free	Free	Free
RT Channelized	-	-	-	-	-	-	-	-	-	-	-	-	-
Storage Length	25	-	-	25	-	-	-	-	-	-	-	-	-
Veh in Median Storage, #	-	0	-	-	0	-	-	-	-	-	-	-	-
Grade, %	-	0	-	-	0	-	-	-	-	-	-	-	-
Peak Hour Factor	90	90	90	90	90	90	90	90	90	90	90	90	90
Heavy Vehicles, %	2	2	2	2	2	2	2	2	2	2	2	2	2
Mvmt Flow	3	1156	67	53	1020	10	8	0	51	6	1	16	16

Smoke Tree Resort
2025 Background AM

9: Scottsdale Rd & Lincoln Dr
Timings

	EBL	EBT	EBR	WBL	WBT	NBL	NBT	SBL	SBT	SBR	
Lane Group											
Lane Configurations	4	4	4	4	4	4	4	4	4	4	
Traffic Volume (vph)	489	42	499	41	39	319	1429	55	1814	652	
Future Volume (vph)	489	42	499	41	39	319	1429	55	1814	652	
Turn Type	Split	NA	pm+ov	Split	NA	Prdt	NA	Prdt	NA	pm+ov	
Protected Phases	4	4	5	8	8	5	2	1	6	4	
Permitted Phases	4	4	5	8	8	5	2	1	6	4	
Detector Phase											
Switch Phase											
Minimum Initial (s)	7.0	7.0	7.0	7.0	7.0	10.0	10.0	5.0	10.0	7.0	
Minimum Split (s)	13.0	13.0	13.0	13.0	13.0	16.7	11.0	16.0	13.0	13.0	
Total Split (s)	30.0	30.0	30.0	30.0	30.0	73.0	14.0	57.0	30.0	30.0	
Total Split (%)	23.1%	23.1%	23.1%	10.0%	10.0%	56.2%	10.8%	43.8%	23.1%	23.1%	
Yellow Time (s)	4.0	4.0	4.0	3.6	3.6	4.0	4.7	3.3	4.7	4.0	
All-Red Time (s)	1.5	1.5	1.5	2.0	2.0	1.5	1.0	2.0	1.0	1.5	
Lost Time Adjust (s)	0.0	0.0	0.0	0.0	0.0	0.0	0.0	0.0	0.0	0.0	
Total Lost Time (s)	5.5	5.5	5.5	5.6	5.6	5.5	5.7	5.3	5.7	5.5	
Lead/Lag				Lead	Lead	Lead	Lag	Lead	Lag		
Lead-Lag Optimize?				None	None	None	None	None	C-Max	None	
Recall Mode				24.3	24.3	44.8	7.2	7.2	20.5	70.7	7.7
Act Effct Green (s)	0.19	0.19	0.34	0.06	0.06	0.16	0.54	0.06	0.43	0.66	
Actuated g/C Ratio	0.94	0.94	0.94	0.47	0.43	0.65	0.59	0.59	0.93	0.66	
v/c Ratio	88.8	88.7	50.9	75.4	33.9	56.8	21.7	81.5	44.4	13.7	
Control Delay	0.0	0.0	0.0	0.0	0.0	0.0	0.0	0.0	0.0	0.0	
Queue Delay	0.0	0.0	0.0	0.0	0.0	0.0	0.0	0.0	0.0	0.0	
Total Delay	88.8	88.7	50.9	75.4	33.9	56.8	21.7	81.5	44.4	13.7	
LOS	F	F	D	E	C	E	C	F	D	B	
Approach Delay				70.4	46.9		27.9		37.3		
Approach LOS				E	D		C		D		
Intersection Summary											
Cycle Length: 130											
Actuated Cycle Length: 130											
Offset: 0 (0%), Referenced to phase 6, SBT, Start of Green											
Natural Cycle: 90											
Control Type: Actuated-Coordinated											
Maximum v/c Ratio: 0.94											
Intersection Signal Delay: 40.7											
Intersection Capacity Utilization 85.8%											
Analysis Period (min) 15											

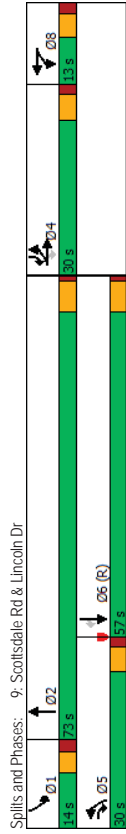

Smoke Tree Resort
2025 Background AM

9: Scottsdale Rd & Lincoln Dr
HCM 6th Signalized Intersection Summary

	EBL	EBT	EBR	WBL	WBT	NBL	NBT	SBL	SBT	SBR
Movement										
Lane Configurations	4	4	4	4	4	4	4	4	4	4
Traffic Volume (veh/h)	489	42	499	41	39	319	1429	43	55	1814
Future Volume (veh/h)	489	42	499	41	39	319	1429	43	55	1814
Initial Q (Ob), veh	0	0	0	0	0	0	0	0	0	0
Ped-Bike Adj(A_pbT)	1.00	1.00	1.00	1.00	1.00	1.00	1.00	1.00	1.00	1.00
Parking Bus, Adj	1.00	1.00	1.00	1.00	1.00	1.00	1.00	1.00	1.00	1.00
Work Zone On Approach	No	No	No	No	No	No	No	No	No	No
Adj Sat Flow, veh/h	1870	1870	1870	1870	1870	1870	1870	1870	1870	1870
Adj Flow Rate, veh/h	577	0	554	46	43	58	354	1588	48	61
Peak Hour Factor	0.90	0.90	0.90	0.90	0.90	0.90	0.90	0.90	0.90	0.90
Percent Heavy Veh, %	2	2	2	2	2	2	2	2	2	2
Cap, veh/h	671	0	489	95	85	414	2404	73	78	2015
Arrive On Green	0.06	0.00	0.06	0.05	0.05	0.12	0.47	0.47	0.04	0.39
Sat Flow, veh/h	3563	0	1585	1781	1777	1585	3456	5093	154	1781
Grp Volume(v), veh/h	577	0	554	46	43	58	354	1061	575	61
Grp Sat Flow(s),veh/h	1781	0	1585	1781	1777	1585	1728	1702	1843	1781
Q Serve(g,s)	20.9	0.0	24.5	3.3	3.1	4.7	13.1	31.1	31.1	4.4
Cycle O Clear(g,c), s	20.9	0.0	24.5	3.3	3.1	4.7	13.1	31.1	31.1	4.4
Prop In Lane	1.00	1.00	1.00	1.00	1.00	1.00	1.00	1.00	1.00	1.00
VC Ratio(X)	0.86	0.00	1.13	0.48	0.45	0.68	0.86	0.66	0.66	0.78
Avail Cap(c,a), veh/h	671	0	489	101	101	90	651	1762	954	119
HCM Platoon Ratio	0.33	0.33	0.33	1.00	1.00	1.00	1.00	1.00	1.00	1.00
Upstream Filter()	1.00	0.00	1.00	1.00	1.00	1.00	1.00	1.00	1.00	1.00
Uniform Delay (d), s/veh	59.3	0.0	50.8	59.8	59.7	60.4	56.1	26.3	26.3	39.2
Incr Delay (d2), s/veh	10.4	0.0	83.0	1.4	1.2	14.2	3.9	0.6	1.1	7.7
%ile BackOfQ(60%) veh/h	11.0	0.0	26.4	1.5	1.4	2.2	5.9	12.6	13.8	2.2
Unsig. Movement Delay, s/veh	69.7	0.0	133.7	61.2	60.9	74.7	60.0	26.9	27.4	69.2
LnGrp Delay(d)s/veh	E	A	F	E	E	E	E	C	C	E
LnGrp LOS	E	A	F	E	E	E	E	C	C	E
Approach Vol, veh/h	1131			147			1990			2801
Approach Delay, s/veh	101.0			66.4			32.9			51.4
Approach LOS	F			E			C			D
Timer - Assigned Phs	1	2	4	5	6	8				
Phs Duration (G+Y+Rc), s	11.0	67.1	30.0	21.1	57.0	12.6				
Change Period (Y+Rc), s	* 5.3	5.7	5.5	5.5	5.7	5.6				
Max Green Setting (Gmax), s	* 8.7	67.3	24.5	24.5	51.3	7.4				
Max Q Clear Time (g_c+I1), s	6.4	33.1	26.5	15.1	53.3	6.7				
Green Ext Time (g_e), s	0.0	2.5	0.0	0.5	0.0	0.0				
Intersection Summary										
HCM 6th Ctrl Delay	55.0									
HCM 6th LOS	D									
Notes										
User approved pedestrian interval to be less than phase max green.										
User approved volume balancing among the lanes for turning movement.										
* HCM 6th computational engine requires equal clearance times for the phases crossing the barrier.										

Smoke Tree Resort
2025 Background PM

1: Mockingbird Ln & Lincoln Drive
Timings

	EBT	WBL	WBT	NBL	NBT	SBL	SBT
Lane Group	EBL	EBT	WBL	WBT	NBL	NBT	SBL
Lane Configurations	2	2	2	2	2	2	2
Traffic Volume (vph)	267	945	25	1011	8	68	67
Future Volume (vph)	267	945	25	1011	8	68	67
Turn Type	pm-plt	NA	Perm	NA	pm+plt	NA	NA
Protected Phases	1	6	2	2	4	3	8
Permitted Phases	6	6	2	2	4	4	8
Detector Phase	1	6	2	2	4	4	3
Switch Phase	4.0	15.0	15.0	7.0	7.0	4.0	7.0
Minimum Initial (s)	8.0	27.0	27.0	33.5	33.5	8.0	33.5
Minimum Split (s)	31.0	88.0	57.0	34.0	34.0	8.0	42.0
Total Split (%)	23.8%	67.7%	43.8%	26.2%	26.2%	6.2%	32.8%
Yellow Time (s)	3.0	4.5	4.5	4.0	4.0	3.0	4.0
All-Red Time (s)	1.0	1.5	1.5	2.5	2.5	1.0	2.5
Lost Time Adjust (s)	0.0	0.0	0.0	0.0	0.0	0.0	0.0
Total Lost Time (s)	4.0	6.0	6.0	6.5	6.5	4.0	6.5
Lead/Lag	Lead	Lag	Lag	Lag	Lag	Lead	Lead
Lead-Lag Optimize?	Yes	Yes	Yes	Yes	Yes	Yes	Yes
Recall Mode	None	C-Max	C-Max	None	None	None	None
Act Effct Green (s)	101.4	99.4	74.6	11.7	11.7	20.6	18.1
Actuated g/C Ratio	0.78	0.76	0.57	0.09	0.09	0.16	0.14
v/c Ratio	0.65	0.40	0.10	0.60	0.13	0.57	0.42
Control Delay	17.9	6.3	16.9	27.7	56.6	62.8	53.7
Queue Delay	0.0	0.0	0.0	0.0	0.0	0.0	0.0
Total Delay	17.9	6.3	16.9	27.7	56.6	62.8	53.7
LOS	B	A	B	C	E	E	D
Approach Delay	8.8	27.5	27.5	62.2	49.2	49.2	49.2
Approach LOS	A	C	C	E	E	D	D

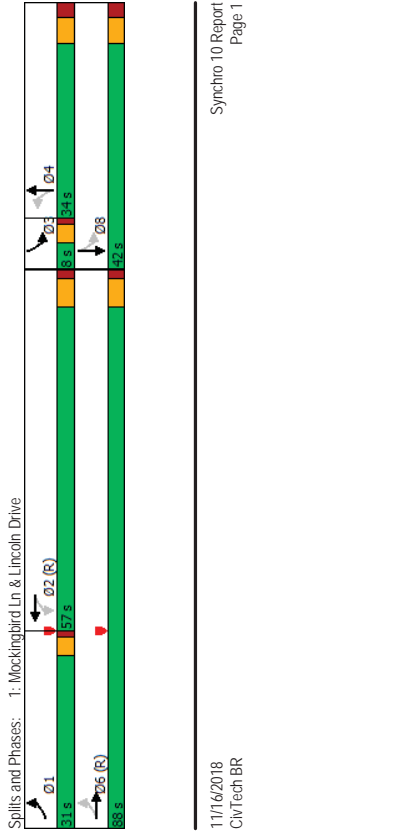

Smoke Tree Resort
2025 Background PM

1: Mockingbird Ln & Lincoln Drive
HCM 6th Signalized Intersection Summary

	EBL	EBT	WBL	WBT	NBL	NBT	SBL	SBT	SBR
Movement	EBL	EBT	WBL	WBT	NBL	NBT	SBL	SBT	SBR
Lane Configurations	2	2	2	2	2	2	2	2	2
Traffic Volume (veh/h)	267	945	25	1011	8	68	19	67	52
Future Volume (veh/h)	267	945	25	1011	8	68	19	67	52
Initial Q (Qb), veh	0	0	0	0	0	0	0	0	0
Ped-Bike Adj(A_pbT)	1.00	1.00	1.00	1.00	1.00	1.00	1.00	1.00	1.00
Parking Bus, Adj	1.00	1.00	1.00	1.00	1.00	1.00	1.00	1.00	1.00
Work Zone On Approach	No	No	No	No	No	No	No	No	No
Adj Sat Flow (veh/h)	1870	1870	1870	1870	1870	1870	1870	1870	1870
Adj Flow Rate, veh/h	297	1050	36	28	1123	76	9	76	21
Peak Hour Factor	0.90	0.90	0.90	0.90	0.90	0.90	0.90	0.90	0.90
Percent Heavy Veh, %	2	2	2	2	2	2	2	2	2
Cap. veh/h	398	2566	88	376	2105	142	85	165	43
Arrive On Green	0.08	0.73	0.73	0.62	0.62	0.11	0.11	0.11	0.03
Sat Flow, veh/h	1781	3505	120	519	3378	228	1134	1410	390
Grp Volume(v), veh/h	297	532	554	28	590	609	9	74	0
Grp Sat Flow(s), veh/h	1781	1777	1849	519	1777	1829	1134	0	1800
Q Serve(g.s), s	7.4	14.9	14.9	2.8	24.4	24.4	1.0	6.6	4.0
Cycle Q Clear(g.c), s	7.4	14.9	14.9	3.5	24.4	24.4	1.0	6.6	4.0
Prop In Lane	1.00	0.07	1.00	1.00	0.12	1.00	0.22	1.00	0.76
Lane Grp Cap(c), veh/h	398	1301	1354	376	1107	1140	85	198	187
V/C Ratio(X)	0.75	0.41	0.41	0.07	0.53	0.53	0.11	0.09	0.39
Avail Cap(c.a), veh/h	628	1301	1354	376	1107	1140	200	381	187
HCM Platoon Ratio	1.00	1.00	1.00	1.00	1.00	1.00	1.00	1.00	1.00
Upstream Filter(0)	1.00	1.00	1.00	0.54	0.54	0.54	1.00	1.00	1.00
Uniform Delay (d), s/veh	13.6	6.7	6.7	10.0	13.8	13.8	62.2	0.0	54.4
Incr Delay (d2), s/veh	2.8	1.0	0.9	0.2	1.0	0.5	0.0	1.9	1.3
Initial Q Delay(Q3), s/veh	0.0	0.0	0.0	0.0	0.0	0.0	0.0	0.0	0.0
%ile Back(Q50%), veh/m	4.0	5.5	5.7	0.3	9.8	10.1	0.3	0.0	3.1
Unsig. Movement Delay, s/veh	16.5	7.6	7.6	10.3	14.8	14.8	62.7	0.0	56.3
LnGrp Delay(d),s/veh	B	A	A	B	B	B	E	A	E
LnGrp LOS	B	A	A	B	B	B	E	A	E
Approach Vol. veh/h	1383	1227	14.7	14.7	106	56.8	320	60.3	60.3
Approach Delay, s/veh	9.5	14.7	14.7	14.7	56.8	56.8	60.3	60.3	60.3
Approach LOS	A	B	B	B	E	E	E	E	E
Timer - Assigned Phs	1	2	3	4	6	8			
Phs Duration (G+Y+Rc), s	14.2	87.0	8.0	20.8	101.2	28.8			
Change Period (Y+Rc), s	4.0	6.0	4.0	6.5	6.0	6.5			
Max Green Setting (Gmax), s	27.0	51.0	4.0	27.5	82.0	35.5			
Max Q Clear Time (g_c+I1), s	9.4	26.4	6.0	14.0	16.9	20.9			
Green EXT Time (g_e), s	0.8	9.6	0.0	0.4	9.6	1.3			
Intersection Summary									
HCM 6th Ctrl Delay	18.6								
HCM 6th LOS	B								

Smoke Tree Resort
2025 Background PM

2: Quail Run Rd & Lincoln Drive
HCM 6th Signalized Intersection Summary

	EBL	EBT	WBT	NBT	SBL	SBT
Lane Group	EBL	EBT	WBT	NBT	SBL	SBT
Lane Configurations	5	4	4	4	4	4
Traffic Volume (vph)	85	963	1008	0	14	0
Future Volume (vph)	85	963	1008	0	14	0
Turn Type	pm-plt	NA	NA	NA	Perm	NA
Protected Phases	7	4	8	2	6	6
Permitted Phases	4	4	8	2	6	6
Detector Phase						
Switch Phase						
Minimum Initial (s)	3.5	15.0	15.0	7.0	7.0	7.0
Minimum Split (s)	8.0	28.0	28.0	33.0	33.0	33.0
Total Split (s)	20.0	94.0	74.0	36.0	36.0	36.0
Total Split (%)	15.4%	72.3%	56.9%	27.7%	27.7%	27.7%
Yellow Time (s)	3.0	4.0	4.0	4.5	4.5	4.5
All-Red Time (s)	1.0	2.5	2.5	1.5	1.5	1.5
Lost Time Adjust (s)	0.0	0.0	0.0	0.0	0.0	0.0
Total Lost Time (s)	4.0	6.5	6.5	6.0	6.0	6.0
Lead/Lag	Lead	Lag	Lag	Lag	Lag	Lag
Lead-Lag Optimize?	Yes	Yes	Yes	Yes	Yes	Yes
Recall Mode	None	None	None	C-Max	C-Max	C-Max
Act Effct Green (s)	71.0	68.5	54.4	49.0	49.0	49.0
Actuated g/C Ratio	0.55	0.53	0.42	0.38	0.38	0.38
v/C Ratio	0.43	0.57	0.78	0.00	0.03	0.14
Control Delay	26.2	31.3	36.1	0.0	30.9	0.4
Queue Delay	0.0	0.0	0.0	0.0	0.0	0.0
Total Delay	26.2	31.3	36.1	0.0	30.9	0.4
LOS	C	C	D	A	C	A
Approach Delay		30.9	36.1		4.5	
Approach LOS		C	D		A	

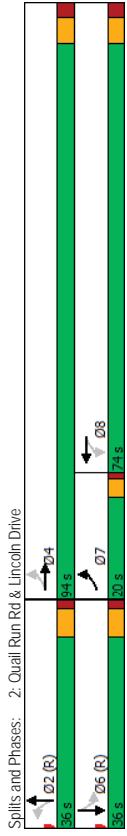

Smoke Tree Resort
2025 Background PM

2: Quail Run Rd & Lincoln Drive
HCM 6th Signalized Intersection Summary

	EBL	EBT	WBL	WBT	NBL	NBT	NBR	SBL	SBT	SBR
Movement	EBL	EBT	WBL	WBT	NBL	NBT	NBR	SBL	SBT	SBR
Lane Configurations	5	4	4	4	4	4	4	4	4	4
Traffic Volume (veh/h)	85	963	1	0	1008	25	0	2	14	0
Future Volume (veh/h)	85	963	1	0	1008	25	0	2	14	0
Initial Q (Obs), veh	0	0	0	0	0	0	0	0	0	0
Ped-Bike Adj(A_pbT)	1.00	1.00	1.00	1.00	1.00	1.00	1.00	1.00	1.00	1.00
Parking Bus, Adj	No	No	No	No	No	No	No	No	No	No
Work Zone On Approach	No	No	No	No	No	No	No	No	No	No
Adj Sat Flow, veh/h	1870	1870	1870	1870	1870	1870	1870	1870	1870	1870
Adj Flow Rate, veh/h	94	1070	1	0	1120	28	0	2	16	0
Peak Hour Factor	0.90	0.90	0.90	0.90	0.90	0.90	0.90	0.90	0.90	0.90
Percent Heavy Veh, %	2	2	2	2	2	2	2	2	2	2
Cap, veh/h	180	1645	2	55	1326	33	0	2	717	695
Arrive On Green	0.09	0.90	0.90	0.00	0.37	0.37	0.00	0.45	0.45	0.00
Sat Flow, veh/h	1781	3643	3	527	3543	89	0	1885	1415	0
Grp Volume(v), veh/h	94	522	549	0	562	586	0	2	16	0
Grp Sat Flow(s), veh/h	1781	1777	1870	527	1777	1864	0	0	1585	1415
Q Serve(g_s), s	4.1	9.0	9.0	0.0	37.6	37.6	0.0	0.1	0.8	0.0
Cycle Q Clear(g_c), s	4.1	9.0	9.0	0.0	37.6	37.6	0.0	0.1	0.9	0.0
Prop In Lane	1.00	0.00	1.00	0.00	1.00	0.05	0.00	1.00	1.00	1.00
Lane Grp Cap(c), veh/h	180	802	844	55	665	694	0	0	717	695
v/C Ratio(x)	0.52	0.65	0.65	0.00	0.84	0.84	0.00	0.00	0.02	0.00
Avail Cap(c_a), veh/h	376	1796	1258	132	923	963	0	0	717	695
HCM Platoon Ratio	2.00	2.00	2.00	1.00	1.00	1.00	1.00	1.00	1.00	1.00
Upstream Filter(i)	0.92	0.92	0.92	0.00	1.00	1.00	0.00	0.00	1.00	1.00
Uniform Delay (d), s/veh	27.8	3.9	3.9	0.0	37.2	37.2	0.0	0.0	19.5	19.8
Incr Delay (d2), s/veh	2.2	0.8	0.8	0.0	5.3	5.1	0.0	0.0	0.1	0.0
Initial Q Delay(d3), s/veh	0.0	0.0	0.0	0.0	0.0	0.0	0.0	0.0	0.0	0.0
%ile BackOfQ(50%), veh/h	1.7	1.8	1.9	0.0	17.2	17.9	0.0	0.0	0.0	0.0
Unsig. Movement Delay, s/veh										
LnGrp Delay(d), s/veh	30.0	4.7	4.7	0.0	42.5	42.3	0.0	0.0	19.5	19.8
LnGrp LOS	C	A	A	A	D	A	A	A	B	A
Approach Vol, veh/h	1165			1148		2			119	
Approach Delay, s/veh	6.7			42.4		19.5			21.1	
Approach LOS	A			D		B			C	
Timer - Assigned Phs	2	4	4	6	7	8				
Phs Duration (G+Y+Rc), s	64.8	65.2	64.8	10.0	55.2					
Change Period (Y+Rc), s	6.0	6.5	6.0	4.0	6.5					
Max Green Setting (Gmax), s	30.0	87.5	30.0	16.0	67.5					
Max Q Clear Time (g_c+I1), s	2.1	11.0	6.9	6.1	39.6					
Green Ext Time (g_e), s	0.0	9.4	0.6	0.1	9.0					
Intersection Summary										
HCM 6th Ctrl Delay		24.3								
HCM 6th LOS		C								

Smoke Tree Resort
2025 Background PM

3: Smoke Tree West & Lincoln Dr
HCM 6th TWSC

Intersection										
Int Delay, s/veh	0									
Movement	EBT	EBR	WBL	WBT	NBL	NBR				
Lane Configurations	↕	↕	↕	↕	↕	↕				
Traffic Vol, veh/h	979	1	0	1032	0	0				
Future Vol, veh/h	979	1	0	1032	0	0				
Conflicting Peds, #/hr	0	0	0	0	0	0				
Sign Control	Free	Free	Free	Free	Stop	Stop				
RT Channelized	-	None	-	None	-	None				
Storage Length	-	-	25	-	0	-				
Veh in Median Storage, #	0	-	-	0	0	-				
Grade, %	0	-	-	0	0	-				
Peak Hour Factor	90	90	90	90	90	90				
Heavy Vehicles, %	2	2	2	2	2	2				
Mvmt Flow	1088	1	0	1147	0	0				
Major/Minor	Major1	Major2	Minor1							
Conflicting Flow All	0	0	1089	0	1663	545				
Stage 1	-	-	-	-	1089	-				
Stage 2	-	-	-	-	574	-				
Critical Hdwy	-	-	4.14	-	6.84	6.94				
Critical Hdwy Stg 1	-	-	-	-	5.84	-				
Critical Hdwy Stg 2	-	-	-	-	5.84	-				
Follow-up Hdwy	-	-	2.22	-	3.52	3.32				
Pl Cap-1 Maneuver	-	-	636	-	88	482				
Stage 1	-	-	-	-	284	-				
Stage 2	-	-	-	-	527	-				
Platoon blocked, %	-	-	-	-	-	-				
Mov Cap-1 Maneuver	-	-	636	-	88	482				
Mov Cap-2 Maneuver	-	-	-	-	204	-				
Stage 1	-	-	-	-	284	-				
Stage 2	-	-	-	-	527	-				
Approach	EB	WB	NB							
HCM Control Delay, s	0	0	0							
HCM LOS				A						
Minor Lane/Major Mvmt	NBLn1	EBT	EBR	WBL	WBT					
Capacity (veh/h)	-	-	-	-	636	-				
HCM Lane V/C Ratio	-	-	-	-	-	-				
HCM Control Delay (s)	0	-	-	-	0	-				
HCM Lane LOS	A	-	-	-	A	-				
HCM 95th %tile Q(veh)	-	-	-	-	0	-				

Smoke Tree Resort
2025 Background PM

4: Smoke Tree East & Lincoln Dr
HCM 6th TWSC

Intersection										
Int Delay, s/veh	0									
Movement	EBT	EBR	WBL	WBT	NBL	NBR				
Lane Configurations	↕	↕	↕	↕	↕	↕				
Traffic Vol, veh/h	978	1	2	1032	2	2				
Future Vol, veh/h	978	1	2	1032	2	2				
Conflicting Peds, #/hr	0	0	0	0	0	0				
Sign Control	Free	Free	Free	Free	Stop	Stop				
RT Channelized	-	None	-	None	-	None				
Storage Length	-	-	25	-	0	-				
Veh in Median Storage, #	0	-	-	0	0	-				
Grade, %	0	-	-	0	0	-				
Peak Hour Factor	90	90	90	90	90	90				
Heavy Vehicles, %	2	2	2	2	2	2				
Mvmt Flow	1087	1	2	1147	2	2				
Major/Minor	Major1	Major2	Minor1							
Conflicting Flow All	0	0	1088	0	1666	544				
Stage 1	-	-	-	-	1088	-				
Stage 2	-	-	-	-	578	-				
Critical Hdwy	-	-	4.14	-	6.84	6.94				
Critical Hdwy Stg 1	-	-	-	-	5.84	-				
Critical Hdwy Stg 2	-	-	-	-	5.84	-				
Follow-up Hdwy	-	-	2.22	-	3.52	3.32				
Pl Cap-1 Maneuver	-	-	637	-	87	483				
Stage 1	-	-	-	-	284	-				
Stage 2	-	-	-	-	524	-				
Platoon blocked, %	-	-	-	-	-	-				
Mov Cap-1 Maneuver	-	-	637	-	87	483				
Mov Cap-2 Maneuver	-	-	-	-	203	-				
Stage 1	-	-	-	-	283	-				
Stage 2	-	-	-	-	524	-				
Approach	EB	WB	NB							
HCM Control Delay, s	0	0	0							
HCM LOS				C						
Minor Lane/Major Mvmt	NBLn1	EBT	EBR	WBL	WBT					
Capacity (veh/h)	286	-	-	-	637	-				
HCM Lane V/C Ratio	0.016	-	-	-	0.003	-				
HCM Control Delay (s)	17.8	-	-	-	10.7	-				
HCM Lane LOS	C	-	-	-	B	-				
HCM 95th %tile Q(veh)	0	-	-	-	0	-				

Smoke Tree Resort
2025 Background PM

5: Lincoln Medical West & Lincoln Dr
HCM 6th TWSC

Intersection	Init Delay, s/veh									
	0.7									
Movement	EBT	EBR	WBL	WBT	NBL	NBR				
Lane Configurations	↕	↕	↕	↕	↕	↕				
Traffic Vol, veh/h	973	7	21	1004	30	26				
Future Vol, veh/h	973	7	21	1004	30	26				
Conflicting Peds, #/hr	0	0	0	0	0	0				
Sign Control	Free	Free	Free	Free	Stop	Stop				
RT Channelized	-	None	-	None	-	None				
Storage Length	-	-	25	-	0	-				
Veh in Median Storage, #	0	-	-	0	0	-				
Grade, %	0	-	-	0	0	-				
Peak Hour Factor	90	90	90	90	90	90				
Heavy Vehicles, %	2	2	2	2	2	2				
Mvmt Flow	1081	8	23	1116	33	29				
Major/Minor	Major1	Major2	Minor1							
Conflicting Flow All	0	0	1089	0	1689	545				
Stage 1	-	-	-	-	1085	-				
Stage 2	-	-	-	-	604	-				
Critical Hdwy	-	-	4.14	-	6.84	6.94				
Critical Hdwy Stg 1	-	-	-	-	5.84	-				
Critical Hdwy Stg 2	-	-	-	-	5.84	-				
Follow-up Hdwy	-	-	2.22	-	3.52	3.32				
Pl Cap-1 Maneuver	-	-	636	-	84	482				
Stage 1	-	-	-	-	285	-				
Stage 2	-	-	-	-	508	-				
Platoon blocked, %	-	-	-	-	-	-				
Mov Cap-1 Maneuver	-	-	636	-	81	482				
Mov Cap-2 Maneuver	-	-	-	-	194	-				
Stage 1	-	-	-	-	275	-				
Stage 2	-	-	-	-	508	-				
Approach	EB	WB	NB							
HCM Control Delay, s	0	0.2	22.4							
HCM LOS	C									
Minor Lane/Major Mvmt	NBLn1	EBT	EBR	WBL	WBT					
Capacity (veh/h)	268	-	-	636	-					
HCM Lane V/C Ratio	0.232	-	-	0.037	-					
HCM Control Delay (s)	22.4	-	-	10.9	-					
HCM Lane LOS	C	-	-	B	-					
HCM 95th %tile Q(veh)	0.9	-	-	0.1	-					

Smoke Tree Resort
2025 Background PM

6: Lincoln Medical East & Lincoln Dr
HCM 6th TWSC

Intersection	Init Delay, s/veh									
	0.2									
Movement	EBT	EBR	WBL	WBT	NBL	NBR				
Lane Configurations	↕	↕	↕	↕	↕	↕				
Traffic Vol, veh/h	995	4	0	1024	2	30				
Future Vol, veh/h	995	4	0	1024	2	30				
Conflicting Peds, #/hr	0	0	0	0	0	0				
Sign Control	Free	Free	Free	Free	Stop	Stop				
RT Channelized	-	None	-	None	-	None				
Storage Length	-	-	25	-	0	-				
Veh in Median Storage, #	0	-	-	0	0	-				
Grade, %	0	-	-	0	0	-				
Peak Hour Factor	90	90	90	90	90	90				
Heavy Vehicles, %	2	2	2	2	2	2				
Mvmt Flow	1106	4	0	1138	2	33				
Major/Minor	Major1	Major2	Minor1							
Conflicting Flow All	0	0	1110	0	1677	555				
Stage 1	-	-	-	-	1108	-				
Stage 2	-	-	-	-	569	-				
Critical Hdwy	-	-	4.14	-	6.84	6.94				
Critical Hdwy Stg 1	-	-	-	-	5.84	-				
Critical Hdwy Stg 2	-	-	-	-	5.84	-				
Follow-up Hdwy	-	-	2.22	-	3.52	3.32				
Pl Cap-1 Maneuver	-	-	625	-	86	475				
Stage 1	-	-	-	-	278	-				
Stage 2	-	-	-	-	530	-				
Platoon blocked, %	-	-	-	-	-	-				
Mov Cap-1 Maneuver	-	-	625	-	86	475				
Mov Cap-2 Maneuver	-	-	-	-	201	-				
Stage 1	-	-	-	-	278	-				
Stage 2	-	-	-	-	530	-				
Approach	EB	WB	NB							
HCM Control Delay, s	0	0	13.9							
HCM LOS	B									
Minor Lane/Major Mvmt	NBLn1	EBT	EBR	WBL	WBT					
Capacity (veh/h)	438	-	-	625	-					
HCM Lane V/C Ratio	0.081	-	-	-	-					
HCM Control Delay (s)	13.9	-	-	0	-					
HCM Lane LOS	B	-	-	A	-					
HCM 95th %tile Q(veh)	0.3	-	-	0	-					

Smoke Tree Resort
2025 Background PM

7: Apartment Drwy & Lincoln Dr
HCM 6th TWSC

Intersection													
Init Delay, s/veh													
3.6													
EBL	EBT	EBR	WBL	WBT	WBR	NBL	NBT	NBR	SBL	SBT	SBR		
8	958	46	7	920	10	74	3	53	8	0	38		
Future Vol, veh/h	8	958	46	7	920	10	74	3	53	8	0	38	
Conflicting Peds, #/hr	0	0	0	0	0	0	0	0	0	0	0	0	0
Sign Control	Free	Free	Free	Free	Free	Free	Free	Free	Free	Free	Free	Free	Free
RT Channelized	-	-	-	-	-	-	-	-	-	-	-	-	-
Storage Length	25	-	-	-	-	-	-	-	-	-	-	-	-
Veh in Median Storage, #	-	0	-	-	-	-	-	-	-	-	-	-	-
Grade, %	-	0	-	-	-	-	-	-	-	-	-	-	-
Peak Hour Factor	90	90	90	90	90	90	90	90	90	90	90	90	90
Heavy Vehicles, %	2	2	2	2	2	2	2	2	2	2	2	2	2
Mvmt Flow	9	1064	51	8	1022	11	82	3	59	9	0	42	
Major/Minor	Major1	Major2	Minor1	Minor2									
Conflicting Flow All	1033	0	0	1115	0	0	1635	2157	558	1596	-	517	
Stage 1	-	-	-	-	-	-	1108	1108	-	1044	-	-	-
Stage 2	-	-	-	-	-	-	527	1049	-	552	-	-	-
Critical Hdwy	4.14	-	-	4.14	-	-	7.54	6.54	6.94	7.54	-	6.94	-
Critical Hdwy Stg 1	-	-	-	-	-	-	6.54	5.54	-	6.54	-	-	-
Critical Hdwy Stg 2	-	-	-	-	-	-	6.54	5.54	-	6.54	-	-	-
Follow-up Hdwy	2.22	-	-	2.22	-	-	3.52	4.02	3.32	3.52	-	3.32	-
Pot Cap-1 Maneuver	668	-	-	622	-	-	-67	47	473	71	0	503	-
Stage 1	-	-	-	-	-	-	224	284	-	245	0	-	-
Stage 2	-	-	-	-	-	-	502	303	-	486	0	-	-
Platoon blocked, %	-	-	-	-	-	-	-	-	-	-	-	-	-
Mov Cap-1 Maneuver	668	-	-	622	-	-	-60	46	473	58	-	503	-
Mov Cap-2 Maneuver	-	-	-	-	-	-	-60	46	-	58	-	-	-
Stage 1	-	-	-	-	-	-	221	280	-	242	-	-	-
Stage 2	-	-	-	-	-	-	454	299	-	415	-	-	-
Approach	EB	WB	NB	SB									
HCM Control Delay, s	0.1	0.1	\$ 382.4	24.1									
HCM LOS	F	F	C	C									
Minor Lane/Major Mvmt	NBLn1	EBL	EBT	EBR	WBL	WBT	WBR	SBLn1	SBLn2				
Capacity (veh/h)	92	668	-	-	622	-	-	58	503				
HCM Lane V/C Ratio	1.57	0.013	-	-	0.013	-	-	0.153	0.084				
HCM Control Delay (s)	\$ 382.4	10.5	-	-	10.9	-	-	78	12.8				
HCM Lane LOS	F	B	-	-	B	-	-	F	B				
HCM 95th %ile Q(veh)	11.3	0	-	-	0	-	-	0.5	0.3				

Notes
- : Volume exceeds capacity \$: Delay exceeds 300s +: Computation Not Defined *: All major volume in platoon

Smoke Tree Resort
2025 Background PM

8: AJ's Drwy & Lincoln Dr
HCM 6th TWSC

Intersection													
Init Delay, s/veh													
3.6													
EBL	EBT	EBR	WBL	WBT	WBR	NBL	NBT	NBR	SBL	SBT	SBR		
12	951	60	69	918	9	16	1	100	5	0	8		
Future Vol, veh/h	12	951	60	69	918	9	16	1	100	5	0	8	
Conflicting Peds, #/hr	0	0	0	0	0	0	0	0	0	0	0	0	0
Sign Control	Free	Free	Free	Free	Free	Free	Free	Free	Free	Free	Free	Free	Free
RT Channelized	-	-	-	-	-	-	-	-	-	-	-	-	-
Storage Length	25	-	-	-	-	-	-	-	-	-	-	-	-
Veh in Median Storage, #	-	0	-	-	-	-	-	-	-	-	-	-	-
Grade, %	-	0	-	-	-	-	-	-	-	-	-	-	-
Peak Hour Factor	90	90	90	90	90	90	90	90	90	90	90	90	90
Heavy Vehicles, %	2	2	2	2	2	2	2	2	2	2	2	2	2
Mvmt Flow	13	1057	67	77	1020	10	18	1	111	6	0	9	
Major/Minor	Major1	Major2	Minor1	Minor2									
Conflicting Flow All	1030	0	0	1124	0	0	1781	2301	562	1734	-	515	
Stage 1	-	-	-	-	-	-	1117	1117	-	1179	-	-	-
Stage 2	-	-	-	-	-	-	664	1184	-	555	-	-	-
Critical Hdwy	4.14	-	-	4.14	-	-	7.54	6.54	6.94	7.54	-	6.94	-
Critical Hdwy Stg 1	-	-	-	-	-	-	6.54	5.54	-	6.54	-	-	-
Critical Hdwy Stg 2	-	-	-	-	-	-	6.54	5.54	-	6.54	-	-	-
Follow-up Hdwy	2.22	-	-	2.22	-	-	3.52	4.02	3.32	3.52	-	3.32	-
Pot Cap-1 Maneuver	670	-	-	617	-	-	-52	38	470	56	0	505	-
Stage 1	-	-	-	-	-	-	221	281	-	202	0	-	-
Stage 2	-	-	-	-	-	-	416	261	-	484	0	-	-
Platoon blocked, %	-	-	-	-	-	-	-	-	-	-	-	-	-
Mov Cap-1 Maneuver	670	-	-	617	-	-	-46	33	470	37	-	505	-
Mov Cap-2 Maneuver	-	-	-	-	-	-	-46	33	-	37	-	-	-
Stage 1	-	-	-	-	-	-	217	276	-	198	-	-	-
Stage 2	-	-	-	-	-	-	358	228	-	361	-	-	-
Approach	EB	WB	NB	SB									
HCM Control Delay, s	0.1	0.8	52.4	53.3									
HCM LOS	F	F	F	F									
Minor Lane/Major Mvmt	NBLn1	EBL	EBT	EBR	WBL	WBT	WBR	SBLn1	SBLn2				
Capacity (veh/h)	198	670	-	-	617	-	-	37	505				
HCM Lane V/C Ratio	0.657	0.02	-	-	0.124	-	-	0.15	0.018				
HCM Control Delay (s)	52.4	10.5	-	-	11.7	-	-	118.8	12.3				
HCM Lane LOS	F	B	-	-	B	-	-	F	B				
HCM 95th %ile Q(veh)	3.9	0.1	-	-	0.4	-	-	0.5	0.1				

	EBL	EBT	EBR	WBL	WBT	NBL	NBT	SBL	SBT	SBR	
EBL	552	61	466	61	68	445	1762	66	1702	527	→
EBT	552	61	466	61	68	445	1762	66	1702	527	→
EBR	Split	NA	pm-ov	Split	NA	Prdt	NA	Prdt	NA	pm-ov	→
WBL	4	4	5	8	8	5	2	1	6	4	←
WBT	4	4	5	8	8	5	2	1	6	4	←
NBL	7.0	7.0	7.0	7.0	7.0	10.0	10.0	5.0	10.0	7.0	←
NBT	13.0	13.0	13.0	13.0	13.0	16.7	11.0	16.0	13.0	13.0	←
SBL	30.0	30.0	30.0	13.0	30.0	73.0	14.0	57.0	30.0	30.0	←
SBT	23.1%	23.1%	23.1%	10.0%	23.1%	56.2%	10.8%	43.8%	23.1%	23.1%	←
SBR	4.0	4.0	4.0	3.6	4.0	4.7	3.3	4.7	4.0	4.0	←
	1.5	1.5	2.0	2.0	1.5	1.0	2.0	1.0	1.5	1.5	←
	0.0	0.0	0.0	0.0	0.0	0.0	0.0	0.0	0.0	0.0	←
	5.5	5.5	5.5	5.6	5.5	5.7	5.3	5.7	5.5	5.5	←
		Lead		Lead		Lead	Lag	Lead	Lag		←
		None		None		None	None	None	C-Max	None	←
		24.5		7.3		7.3	22.2	70.3	8.0	53.7	←
		0.19		0.36		0.06	0.17	0.54	0.06	0.41	←
		1.07		0.85		0.62	0.84	0.74	0.67	0.90	←
		119.1		121.1		37.3	92.9	39.0	66.0	25.4	←
		0.0		0.0		0.0	0.0	0.0	0.0	0.0	←
		119.1		37.3		92.9	39.0	66.0	25.4	88.3	←
		F		D		F	D	E	C	F	←
		F		D		F	D	E	C	F	←
		84.3		54.9		33.4				37.3	←
		F		D		D		C		D	←
Intersection Summary											
Cycle Length: 130											
Actuated Cycle Length: 130											
Offset: 0 (0%), Referenced to phase 6 SBT, Start of Green											
Natural Cycle: 100											
Control Type: Actuated-Coordinated											
Maximum v/c Ratio: 1.07											
Intersection Signal Delay: 45.1											
Intersection Capacity Utilization 86.9%											
Analysis Period (min) 15											

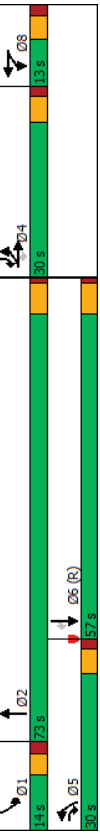

	EBL	EBT	EBR	WBL	WBT	NBL	NBT	SBL	SBT	SBR	
EBL	552	61	466	61	68	445	1762	66	1702	527	→
EBT	552	61	466	61	68	445	1762	66	1702	527	→
EBR	0	0	0	0	0	0	0	0	0	0	→
WBL	1.00	1.00	1.00	1.00	1.00	1.00	1.00	1.00	1.00	1.00	←
WBT	1.00	1.00	1.00	1.00	1.00	1.00	1.00	1.00	1.00	1.00	←
NBL	1.00	1.00	1.00	1.00	1.00	1.00	1.00	1.00	1.00	1.00	←
NBT	1.00	1.00	1.00	1.00	1.00	1.00	1.00	1.00	1.00	1.00	←
SBL	1.00	1.00	1.00	1.00	1.00	1.00	1.00	1.00	1.00	1.00	←
SBT	1.00	1.00	1.00	1.00	1.00	1.00	1.00	1.00	1.00	1.00	←
SBR	1.00	1.00	1.00	1.00	1.00	1.00	1.00	1.00	1.00	1.00	←
Work Zone On Approach											
Adj Sat Flow: veh/h											
Adj Flow Rate: veh/h											
Peak Hour Factor											
Percent Heavy Veh. %											
Cap. veh/h											
Arrive On Green											
Sat Flow: veh/h											
Grp Sat Flow(s):veh/h											
Q Serve(g,s)											
Cycle O Clear(g,c)											
Prop In Lane											
Lane Grp Cap(c)											
V/C Ratio(x)											
Avail Cap(c,a)											
HCM Platoon Ratio											
Upstream Filter()											
Uniform Delay (d)											
Incr Delay (d2)											
Initial O Delay(g3)											
%ile BackOfQ(50%)											
Unsig. Movement Delay: s/veh											
LnGrp Delay(d)s/veh											
LnGrp LOS											
Approach Vol: veh/h											
Approach Delay: s/veh											
Approach LOS											
Timer - Assigned Phs											
Phs Duration (G+Y+R): s											
Change Period (Y+R): s											
Max Green Setting (Gmax): s											
Max O Clear Time (g_c+I1): s											
Green EXT Time (g_e_c): s											
Intersection Summary											
HCM 6th Ctrl Delay											
HCM 6th LOS											
Notes											
User approved pedestrian interval to be less than phase max green.											
User approved volume balancing among the lanes for turning movement.											
* HCM 6th computational engine requires equal clearance times for the phases crossing the barrier.											

Smoke Tree Resort
2025 Total AM

1: Mockingbird Ln & Lincoln Drive
Timings

	EBT	WBL	NBL	NBT	SBL	SBT
Lane Group	EBL	EBT	WBL	NBL	NBT	SBL
Lane Configurations	4	4	4	4	4	4
Traffic Volume (vph)	242	1056	25	971	6	37
Future Volume (vph)	242	1056	25	971	6	37
Turn Type	pm-plt	NA	Perm	NA	pm+pt	NA
Protected Phases	1	6	2	2	4	3
Permitted Phases	6	6	2	2	4	8
Detector Phase	1	6	2	2	4	3
Switch Phase						
Minimum Initial (s)	3.5	15.0	15.0	7.0	7.0	3.5
Minimum Split (s)	8.0	27.0	27.0	33.5	8.0	33.5
Total Split (s)	27.0	77.0	50.0	44.0	44.0	9.0
Total Split (%)	20.8%	59.2%	38.5%	33.8%	33.8%	6.9%
Yellow Time (s)	3.0	4.5	4.5	4.0	3.0	4.0
All-Red Time (s)	1.0	1.5	1.5	2.5	1.0	2.5
Lost Time Adjust (s)	0.0	0.0	0.0	0.0	0.0	0.0
Total Lost Time (s)	4.0	6.0	6.0	6.5	6.5	4.0
Lead/Lag	Lead	Lag	Lag	Lag	Lag	Lead
Lead-Lag Optimize?	Yes	Yes	Yes	Yes	Yes	Yes
Recall Mode	None	C-Max	C-Max	None	None	None
Act Effct Green (s)	90.6	88.6	65.5	19.6	19.6	31.4
Actuated g/C Ratio	0.70	0.68	0.50	0.15	0.15	0.24
v/C Ratio	0.67	0.50	0.13	0.64	0.09	0.32
Control Delay	22.4	12.1	23.4	30.6	44.3	30.2
Queue Delay	0.0	0.0	0.0	0.0	0.0	0.0
Total Delay	22.4	12.1	23.4	30.6	44.3	30.2
LOS	C	B	C	D	C	D
Approach Delay		13.9		30.4		31.5
Approach LOS		B		C		D
Intersection Summary						
Cycle Length: 130						
Actuated Cycle Length: 130						
Offset: 0 (0%), Referenced to phase 2:WBL and 6:EBTL, Start of Green						
Natural Cycle: 90						
Control Type: Actuated-Coordinated						
Maximum v/C Ratio: 0.85						
Intersection Signal Delay: 25.6						
Intersection Capacity Utilization 78.8%						
Analysis Period (min) 15						

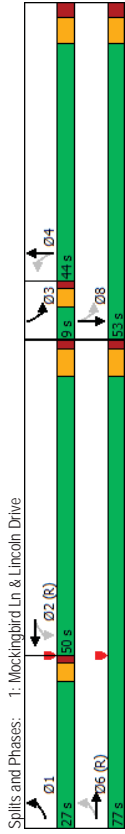

Smoke Tree Resort
2025 Total AM

1: Mockingbird Ln & Lincoln Drive
HCM 6th Signalized Intersection Summary

	EBL	EBT	EBR	WBL	WBT	WBR	NBL	NBT	NBR	SBL	SBT	SBR
Movement	EBL	EBT	EBR	WBL	WBT	WBR	NBL	NBT	NBR	SBL	SBT	SBR
Lane Configurations	4	4	4	4	4	4	4	4	4	4	4	4
Traffic Volume (veh/h)	242	1056	33	25	971	48	6	37	25	86	96	253
Future Volume (veh/h)	242	1056	33	25	971	48	6	37	25	86	96	253
Initial Q (Obs.) veh	0	0	0	0	0	0	0	0	0	0	0	0
Ped-Bike Adj(A_pbT)	1.00	1.00	1.00	1.00	1.00	1.00	1.00	1.00	1.00	1.00	1.00	1.00
Parking Bus, Adj	No	No	No	No	No	No	No	No	No	No	No	No
Work Zone On Approach												
Adj Sat Flow (veh/h)	1870	1870	1870	1870	1870	1870	1870	1870	1870	1870	1870	1870
Adj Flow Rate	269	1173	37	28	1079	53	7	41	28	96	107	281
Peak Hour Factor	0.90	0.90	0.90	0.90	0.90	0.90	0.90	0.90	0.90	0.90	0.90	0.90
Percent Heavy Veh. %	2	2	2	2	2	2	2	2	2	2	2	2
Cap. veh/h	344	2366	71	271	1818	89	88	197	135	333	118	311
Arrive On Green	0.09	0.64	0.64	0.35	0.35	0.35	0.19	0.19	0.19	0.04	0.26	0.26
Sat Flow (veh/h)	1781	3516	111	462	3447	169	996	1036	707	1781	456	1198
Grp Volume(v), veh/h	269	593	617	28	556	576	7	0	69	96	0	388
Grp Sat Flow(s),veh/h	1781	1777	1850	462	1777	1840	996	0	1743	1781	0	1655
Q Serve(g.s), s	8.6	23.1	23.2	5.6	33.3	33.3	0.9	0.0	4.3	5.0	0.0	29.5
Cycle Q Clear(g.c), s	8.6	23.1	23.2	13.6	33.3	33.3	21.4	0.0	4.3	5.0	0.0	29.5
Prop In Lane	1.00	0.06	1.00	1.00	1.00	0.09	1.00	0.01	1.00	0.01	1.00	0.72
Lane Grp Cap(c), veh/h	344	1145	1192	271	937	970	88	0	332	333	0	429
v/C Ratio(x)	0.78	0.52	0.52	0.10	0.59	0.59	0.08	0.00	0.21	0.29	0.00	0.90
Avail Cap(c.a), veh/h	505	1145	1192	271	937	970	186	0	503	333	0	592
HCM Platoon Ratio	1.00	1.00	1.00	0.67	0.67	0.67	1.00	1.00	1.00	1.00	1.00	1.00
Upstream Filter(i)	1.00	1.00	1.00	0.55	0.55	0.55	1.00	0.00	1.00	1.00	0.00	1.00
Uniform Delay (d), s/veh	20.8	12.3	12.3	27.1	30.6	30.6	61.3	0.0	44.4	40.0	0.0	46.6
Incr Delay (d2), s/veh	4.8	1.7	1.6	0.4	1.5	1.5	0.4	0.0	0.3	0.5	0.0	13.7
Initial Q Delay(g3),s/veh	0.0	0.0	0.0	0.0	0.0	0.0	0.0	0.0	0.0	0.0	0.0	0.0
%ile BackOfQ(50%),veh/h	4.5	9.4	9.8	0.7	15.5	16.0	0.2	0.0	1.9	2.5	0.0	13.7
Unsig. Movement Delay, s/veh												
LnGrp Delay(d) s/veh	25.6	14.0	13.9	27.5	32.2	32.1	61.6	0.0	44.7	40.5	0.0	60.3
LnGrp LOS	C	B	B	C	C	C	E	A	D	D	A	E
Approach Vol. veh/h	1479			1160			76				484	
Approach Delay, s/veh	16.1			32.0			46.2				56.4	
Approach LOS	B			C			D				E	
Timer - Assigned Phs	1	2	3	4	6	8						
Phs Duration (G+Y+Rc), s	15.2	74.6	9.0	31.2	89.8	40.2						
Change Period (Y+Rc), s	4.0	6.0	4.0	6.5	6.0	6.5						
Max Green Setting (Gmax), s	23.0	44.0	5.0	37.5	71.0	46.5						
Max Q Clear Time (g_c+I1), s	10.6	35.3	7.0	23.4	25.2	31.5						
Green Ext Time (g_e), s	0.6	4.9	0.0	0.2	11.1	2.2						
Intersection Summary												
HCM 6th Ctrl Delay							28.7					
HCM 6th LOS							C					

Smoke Tree Resort
2025 Total AM
Timings

Smoke Tree Resort
2025 Total AM
HCM 6th Signalized Intersection Summary

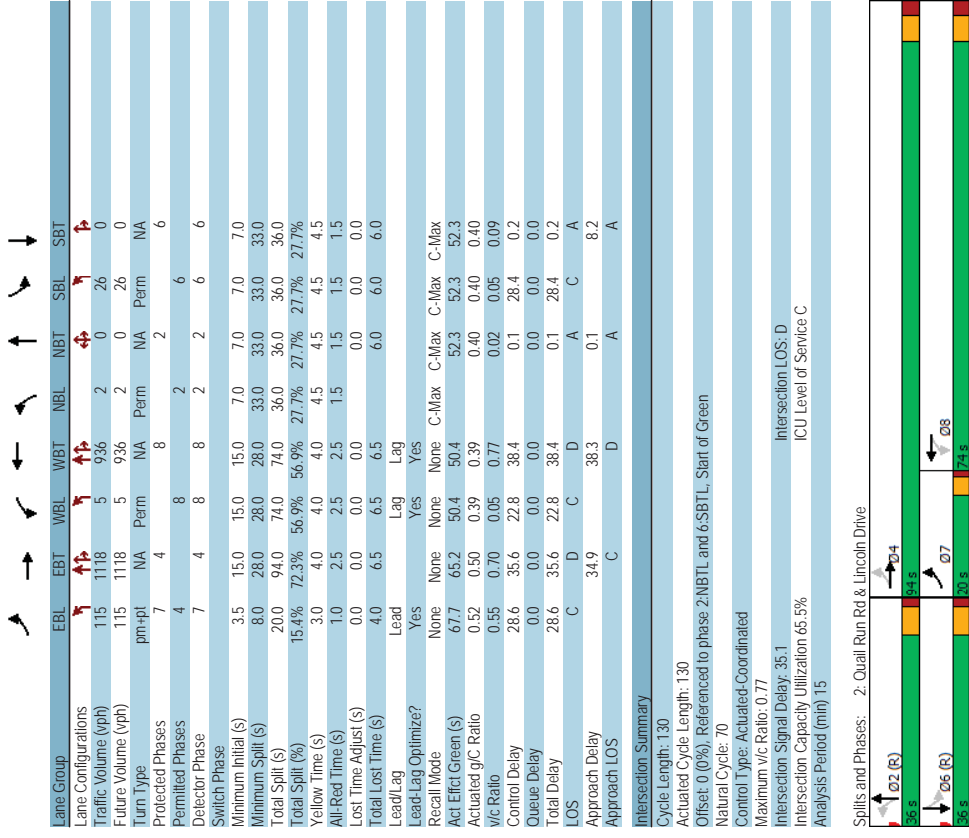

Smoke Tree Resort
2025 Total AM

Movement	EBL	EBT	EBR	WBL	WBT	WBR	NBL	NBT	NBR	SBL	SBT	SBR																								
Lane Configurations	1	1	1	1	1	1	1	1	1	1	1	1																								
Traffic Volume (veh/h)	115	1118	4	5	936	12	2	0	10	26	0	66																								
Future Volume (veh/h)	115	1118	4	5	936	12	2	0	10	26	0	66																								
Initial Q (Obs) veh	0	0	0	0	0	0	0	0	0	0	0	0																								
Ped-Bike Adj(A_pbT)	1.00	1.00	1.00	1.00	1.00	1.00	1.00	1.00	1.00	1.00	1.00	1.00																								
Work Zone On Approach	No																																			
Adj Sat Flow (veh/h)	1870	1870	1870	1870	1870	1870	1870	1870	1870	1870	1870	1870																								
Adj Flow Rate, veh/h	128	1242	4	6	1040	13	2	0	11	29	0	73																								
Peak Hour Factor	0.90	0.90	0.90	0.90	0.90	0.90	0.90	0.90	0.90	0.90	0.90	0.90																								
Percent Heavy Veh, %	2	2	2	2	2	2	2	2	2	2	2	2																								
Cap. veh/h	207	1592	5	191	1243	16	122	21	612	711	0	738																								
Arrive On Green	0.12	0.88	0.88	0.35	0.35	0.35	0.47	0.00	0.47	0.47	0.00	0.47																								
Sat Flow, veh/h	1781	3633	12	446	3594	45	194	45	1315	1404	0	1585																								
Grp Volume(v), veh/h	128	607	639	6	514	539	13	0	29	0	0	73																								
Grp Sat Flow(s), veh/h	1781	1777	1868	446	1777	1862	1554	0	0	1404	0	1585																								
Q Serve(g.s), s	5.9	17.4	17.4	1.2	34.6	34.6	0.6	0.0	0.0	0.8	0.0	3.4																								
Cycle Q Clear(g.c), s	5.9	17.4	17.4	6.6	34.6	34.6	0.6	0.0	0.0	1.3	0.0	3.4																								
Prop In Lane	1.00	1.00	1.00	1.00	1.00	1.00	1.00	1.00	1.00	1.00	1.00	1.00																								
Lane Grp Cap(c), veh/h	207	778	819	191	615	644	756	0	0	711	0	738																								
VC Ratio(X)	0.62	0.78	0.78	0.03	0.84	0.84	0.02	0.00	0.00	0.04	0.00	0.10																								
Avail Cap(c.a), veh/h	317	1196	1257	269	923	967	756	0	0	711	0	738																								
HCM Platoon Ratio	2.00	2.00	2.00	1.00	1.00	1.00	1.00	1.00	1.00	1.00	1.00	1.00																								
Upstream Filter(0)	0.87	0.87	0.87	1.00	1.00	1.00	1.00	0.00	0.00	1.00	0.00	1.00																								
Uniform Delay (d), s/veh	28.0	5.6	5.6	31.9	39.1	39.1	18.7	0.0	0.0	18.9	0.0	19.5																								
Incr Delay (d2), s/veh	2.6	1.6	1.5	0.1	4.3	4.1	0.0	0.0	0.0	0.1	0.0	0.3																								
Initial Q Delay(g3), s/veh	0.0	0.0	0.0	0.0	0.0	0.0	0.0	0.0	0.0	0.0	0.0	0.0																								
%ile Back(Q50%), veh/m	2.4	2.9	3.0	0.1	15.7	16.5	0.2	0.0	0.0	0.5	0.0	1.3																								
Unsig. Movement Delay, s/veh	30.6																																			
LnGrp Delay(d), s/veh	30.6			7.2			7.1			31.9			43.5			43.3			18.7			18.7			0.0			19.0			0.0			19.7		
LnGrp LOS	C			A			A			C			D			D			B			B			A			A			B			A		
Approach Vol. veh/h	1374																																			
Approach Delay, s/veh	9.3																																			
Approach LOS	A																																			
Timer - Assigned Phs	2																																			
Phs Duration (G+Y+Rc), s	66.5																																			
Change Period (Y+Rc), s	6.0																																			
Max Green Selling (Gmax), s	30.0																																			
Max Q Clear Time (g_c+H), s	2.6																																			
Green Ext Time (g_e), s	0.0																																			
Intersection Summary	23.9																																			
HCM 6th Ctrl Delay	C																																			

Smoke Tree Resort
2025 Total AM

3: Smoke Tree West & Lincoln Dr
HCM 6th TWSC

Intersection	Init Delay, s/veh									
	0									
Movement	EBT	EBR	WBL	WBT	NBL	NBR				
Lane Configurations	↔	↔		↔		↔				
Traffic Vol, veh/h	1144	0	0	949	0	6				
Future Vol, veh/h	1144	0	0	949	0	6				
Conflicting Peds, #/hr	0	0	0	0	0	0				
Sign Control	Free	Free	Free	Free	Stop	Stop				
RT Channelized	-	None	-	None	-	None				
Storage Length	-	-	-	-	-	0				
Veh in Median Storage, #	0	-	-	0	0	0				
Grade, %	0	-	-	0	0	-				
Peak Hour Factor	90	90	90	90	90	90				
Heavy Vehicles, %	2	2	2	2	2	2				
Mvmt Flow	1271	11	0	1054	0	7				
Major/Minor	Major1	Major2	Minor1							
Conflicting Flow All	0	0	-	-	-	-	641			
Stage 1	-	-	-	-	-	-	-			
Stage 2	-	-	-	-	-	-	-			
Critical Hdwy	-	-	-	-	-	-	6.94			
Critical Hdwy Stg 1	-	-	-	-	-	-	-			
Critical Hdwy Stg 2	-	-	-	-	-	-	-			
Follow-up Hdwy	-	-	-	-	-	-	3.32			
Pl Cap-1 Maneuver	-	0	-	0	-	0	417			
Stage 1	-	0	-	0	-	0	-			
Stage 2	-	0	-	0	-	0	-			
Platoon blocked, %	-	-	-	-	-	-	-			
Mov Cap-1 Maneuver	-	-	-	-	-	-	417			
Mov Cap-2 Maneuver	-	-	-	-	-	-	-			
Stage 1	-	-	-	-	-	-	-			
Stage 2	-	-	-	-	-	-	-			
Approach	EB	WB	NB							
HCM Control Delay, s	0	0	13.8							
HCM LOS	B									
Minor Lane/Major Mvmt	NBLn1	EBT	EBR	WBL	WBT					
Capacity (veh/h)	417	-	-	-	-					
HCM Lane V/C Ratio	0.016	-	-	-	-					
HCM Control Delay (s)	13.8	-	-	-	-					
HCM Lane LOS	B	-	-	-	-					
HCM 95th %tile Q(veh)	0	-	-	-	-					

Smoke Tree Resort
2025 Total AM

4: Smoke Tree East & Lincoln Dr
HCM 6th TWSC

Intersection	Init Delay, s/veh									
	0.5									
Movement	EBT	EBR	WBL	WBT	NBL	NBR				
Lane Configurations	↔	↔		↔		↔				
Traffic Vol, veh/h	1145	7	27	937	15	14				
Future Vol, veh/h	1145	7	27	937	15	14				
Conflicting Peds, #/hr	0	0	0	0	0	0				
Sign Control	Free	Free	Free	Free	Stop	Stop				
RT Channelized	-	None	-	None	-	None				
Storage Length	-	-	25	-	0	-				
Veh in Median Storage, #	0	-	-	0	0	-				
Grade, %	0	-	-	0	0	-				
Peak Hour Factor	90	90	90	90	90	90				
Heavy Vehicles, %	2	2	2	2	2	2				
Mvmt Flow	1272	8	30	1041	17	16				
Major/Minor	Major1	Major2	Minor1							
Conflicting Flow All	0	0	1280	0	1857	640				
Stage 1	-	-	-	-	1276	-				
Stage 2	-	-	-	-	-	581				
Critical Hdwy	-	-	4.14	-	6.84	6.94				
Critical Hdwy Stg 1	-	-	-	-	5.84	-				
Critical Hdwy Stg 2	-	-	-	-	5.84	-				
Follow-up Hdwy	-	2.22	-	3.52	3.32	-				
Pl Cap-1 Maneuver	-	538	-	65	418	-				
Stage 1	-	-	-	226	-	-				
Stage 2	-	-	-	-	522	-				
Platoon blocked, %	-	-	-	-	-	-				
Mov Cap-1 Maneuver	-	538	-	61	418	-				
Mov Cap-2 Maneuver	-	-	-	198	-	-				
Stage 1	-	-	-	213	-	-				
Stage 2	-	-	-	-	522	-				
Approach	EB	WB	NB							
HCM Control Delay, s	0	0.3	23.6							
HCM LOS	C									
Minor Lane/Major Mvmt	NBLn1	EBT	EBR	WBL	WBT					
Capacity (veh/h)	226	-	-	538	-					
HCM Lane V/C Ratio	0.143	-	-	0.056	-					
HCM Control Delay (s)	23.6	-	-	12.1	-					
HCM Lane LOS	C	-	-	B	-					
HCM 95th %tile Q(veh)	0.5	-	-	0.2	-					

Smoke Tree Resort
2025 Total AM

5: Lincoln Medical West & Lincoln Dr
HCM 6th TWSC

Intersection											
Int Delay, s/veh	0.4										
Movement	EBT	EBR	WBL	WBT	NBL	NBR					
Lane Configurations	↔	↔	↔	↔	↔	↔					
Traffic Vol, veh/h	1142	18	48	957	6	9					
Future Vol, veh/h	1142	18	48	957	6	9					
Conflicting Peds, #/hr	0	0	0	0	0	0					
Sign Control	Free	Free	Free	Free	Stop	Stop					
RT Channelized	-	None	-	None	-	None					
Storage Length	-	-	25	-	0	-					
Veh in Median Storage, #	0	-	-	0	0	-					
Grade, %	0	-	-	-	0	0					
Peak Hour Factor	90	90	90	90	90	90					
Heavy Vehicles, %	2	2	2	2	2	2					
Mvmt Flow	1269	20	53	1063	7	10					
Major/Minor	Major1	Major2	Minor1								
Conflicting Flow All	0	0	1289	0	1917	645					
Stage 1	-	-	-	-	1279	-					
Stage 2	-	-	-	-	-	638					
Critical Hdwy	-	-	4.14	-	6.84	6.94					
Critical Hdwy Stg 1	-	-	-	-	-	5.84					
Critical Hdwy Stg 2	-	-	-	-	3.52	3.32					
Follow-up Hdwy	-	-	2.22	-	-	-					
Pl Cap-1 Maneuver	-	-	534	-	59	415					
Stage 1	-	-	-	-	225	-					
Stage 2	-	-	-	-	-	488					
Platoon blocked, %	-	-	-	-	-	-					
Mov Cap-1 Maneuver	-	-	534	-	53	415					
Mov Cap-2 Maneuver	-	-	-	-	147	-					
Stage 1	-	-	-	-	203	-					
Stage 2	-	-	-	-	-	488					
Approach	EB	WB	NB								
HCM Control Delay, s	0	0.6	21.1								
HCM LOS	C										
Minor Lane/Major Mvmt	NBLn1	EBT	EBR	WBL	WBT						
Capacity (veh/h)	240	-	-	534	-						
HCM Lane V/C Ratio	0.069	-	-	0.1	-						
HCM Control Delay (s)	21.1	-	-	12.5	-						
HCM Lane LOS	C	-	-	B	-						
HCM 95th %tile Q(veh)	0.2	-	-	0.3	-						

Smoke Tree Resort
2025 Total AM

6: Lincoln Medical East & Lincoln Dr
HCM 6th TWSC

Intersection											
Int Delay, s/veh	0.1										
Movement	EBT	EBR	WBL	WBT	NBL	NBR					
Lane Configurations	↔	↔	↔	↔	↔	↔					
Traffic Vol, veh/h	1138	11	0	1005	0	9					
Future Vol, veh/h	1138	11	0	1005	0	9					
Conflicting Peds, #/hr	0	0	0	0	0	0					
Sign Control	Free	Free	Free	Free	Stop	Stop					
RT Channelized	-	None	-	None	-	None					
Storage Length	-	-	-	-	-	0					
Veh in Median Storage, #	0	-	-	0	0	-					
Grade, %	0	-	-	-	0	0					
Peak Hour Factor	90	90	90	90	90	90					
Heavy Vehicles, %	2	2	2	2	2	2					
Mvmt Flow	1264	12	0	1117	0	10					
Major/Minor	Major1	Major2	Minor1								
Conflicting Flow All	0	0	-	-	-	638					
Stage 1	-	-	-	-	-	-					
Stage 2	-	-	-	-	-	-					
Critical Hdwy	-	-	-	-	-	6.94					
Critical Hdwy Stg 1	-	-	-	-	-	-					
Critical Hdwy Stg 2	-	-	-	-	-	-					
Follow-up Hdwy	-	-	-	-	-	3.32					
Pl Cap-1 Maneuver	-	-	0	-	0	419					
Stage 1	-	-	0	-	0	-					
Stage 2	-	-	0	-	0	-					
Platoon blocked, %	-	-	-	-	-	-					
Mov Cap-1 Maneuver	-	-	-	-	-	419					
Mov Cap-2 Maneuver	-	-	-	-	-	-					
Stage 1	-	-	-	-	-	-					
Stage 2	-	-	-	-	-	-					
Approach	EB	WB	NB								
HCM Control Delay, s	0	0	13.8								
HCM LOS	B										
Minor Lane/Major Mvmt	NBLn1	EBT	EBR	WBL	WBT						
Capacity (veh/h)	419	-	-	-	-						
HCM Lane V/C Ratio	0.024	-	-	-	-						
HCM Control Delay (s)	13.8	-	-	-	-						
HCM Lane LOS	B	-	-	-	-						
HCM 95th %tile Q(veh)	0.1	-	-	-	-						

Smoke Tree Resort
2025 Total AM

7: Apartment Drwy & Lincoln Dr
HCM 6th TWSC

Intersection															
Init Delay, s/veh															
17.7															
EBL	EBT	EBR	WBL	WBT	WBR	NBL	NBT	NBR	SBL	SBT	SBR				
38	20	934	11	56	0	33	6	0	14						
29	1082	38	20	934	11	56	0	33	6	0	14				
29	1082	38	20	934	11	56	0	33	6	0	14				
Free	Free	Free	Free	Free	Free	Free	Free	Free	Free	Free	Free	Stop	Stop	Stop	
-	-	None	-	None	-	None	-	None	-	None	-	-	None	-	
25	-	-	25	-	-	-	-	-	-	-	-	0	-	0	
-	0	-	-	-	-	-	-	-	-	-	-	-	-	-	
90	90	90	90	90	90	90	90	90	90	90	90	90	90	90	
2	2	2	2	2	2	2	2	2	2	2	2	2	2	2	
32	1202	42	22	1038	12	62	0	37	7	0	16				
Major/Minor	Major1	Major2	Minor1	Minor2											
Conflicting Flow All	1050	0	0	1850	2381	622	1753	-	525						
Stage 1	-	-	-	1287	1287	-	1088	-	-						
Stage 2	-	-	-	563	1094	-	665	-	-						
Critical Hdwy	4.14	-	-	7.54	6.54	6.94	7.54	-	6.94						
Critical Hdwy Stg 1	-	-	-	6.54	5.54	-	6.54	-	-						
Critical Hdwy Stg 2	-	-	-	6.54	5.54	-	6.54	-	-						
Follow-up Hdwy	2.22	-	-	3.52	4.02	3.32	3.52	-	3.32						
Plat Cap-1 Maneuver	659	-	-	-	46	34	480	54	0	497					
Stage 1	-	-	-	174	233	-	230	0	-						
Stage 2	-	-	-	478	288	-	416	0	-						
Platoon blocked, %	-	-	-	-	-	-	-	-	-						
Mov Cap-1 Maneuver	659	-	-	555	-	-	42	31	430	46	-	497			
Mov Cap-2 Maneuver	-	-	-	-	-	-	42	31	-	46	-	-			
Stage 1	-	-	-	165	222	-	219	-	-						
Stage 2	-	-	-	445	276	-	362	-	-						
Approach	EB	WB	NB	SB											
HCM Control Delay, s	0.3	0.2	\$ 428.6	37.6											
HCM LOS	F	F	F	E											
Minor Lane/Major Mvmt	NBLn1	EBL	EBT	EBR	WBL	WBT	WBR	SBLn1	SBLn2						
Capacity (veh/h)	63	659	-	-	555	-	-	46	497						
HCM Lane V/C Ratio	1.57	0.049	-	-	0.04	-	-	0.145	0.031						
HCM Control Delay (s)	\$ 428.6	10.7	-	-	11.8	-	-	96.1	12.5						
HCM Lane LOS	F	B	-	-	B	-	-	F	B						
HCM 95th %ile Q(veh)	8.7	0.2	-	-	0.1	-	-	0.5	0.1						

Notes
- Volume exceeds capacity \$: Delay exceeds 300s +: Computation Not Defined *: All major volume in platoon

Smoke Tree Resort
2025 Total AM

8: AJ's Drwy & Lincoln Dr
HCM 6th TWSC

Intersection															
Init Delay, s/veh															
1.4															
EBL	EBT	EBR	WBL	WBT	WBR	NBL	NBT	NBR	SBL	SBT	SBR				
3	1060	60	48	947	9	7	0	46	5	1	14				
3	1060	60	48	947	9	7	0	46	5	1	14				
0	0	0	0	0	0	0	0	0	0	0	0	0	0	0	
Free	Free	Free	Free	Free	Free	Free	Free	Free	Free	Free	Free	Stop	Stop	Stop	
-	-	None	-	None	-	None	-	None	-	None	-	-	None	-	
25	-	-	25	-	-	-	-	-	-	-	-	0	-	0	
-	0	-	-	-	-	-	-	-	-	-	-	-	-	-	
90	90	90	90	90	90	90	90	90	90	90	90	90	90	90	
2	2	2	2	2	2	2	2	2	2	2	2	2	2	2	
3	1178	67	53	1052	10	8	0	51	6	1	16				
Major/Minor	Major1	Major2	Minor1	Minor2											
Conflicting Flow All	1062	0	0	1245	0	0	1851	2386	623	1758	2414	531			
Stage 1	-	-	-	-	-	-	1218	1218	-	1163	1163	-			
Stage 2	-	-	-	-	-	-	633	1168	-	595	1251	-			
Critical Hdwy	4.14	-	-	4.14	-	-	7.54	6.54	6.94	7.54	6.54	6.94			
Critical Hdwy Stg 1	-	-	-	6.54	5.54	-	6.54	5.54	-	6.54	5.54	-			
Critical Hdwy Stg 2	-	-	-	6.54	5.54	-	6.54	5.54	-	6.54	5.54	-			
Follow-up Hdwy	2.22	-	-	2.22	-	-	3.52	4.02	3.32	3.52	4.02	3.32			
Plat Cap-1 Maneuver	652	-	-	555	-	-	46	34	429	54	32	493			
Stage 1	-	-	-	191	251	-	207	267	-	-	-	-			
Stage 2	-	-	-	434	266	-	458	242	-	-	-	-			
Platoon blocked, %	-	-	-	-	-	-	-	-	-	-	-	-			
Mov Cap-1 Maneuver	652	-	-	555	-	-	40	31	429	44	29	493			
Mov Cap-2 Maneuver	-	-	-	-	-	-	40	31	-	44	29	-			
Stage 1	-	-	-	190	250	-	206	242	-	-	-	-			
Stage 2	-	-	-	378	241	-	402	241	-	-	-	-			
Approach	EB	WB	NB	SB											
HCM Control Delay, s	0	0.6	0.6	32.6											
HCM LOS	D	D	D	E											
Minor Lane/Major Mvmt	NBLn1	EBL	EBT	EBR	WBL	WBT	WBR	SBLn1	SBLn2						
Capacity (veh/h)	188	652	-	-	555	-	-	44	493						
HCM Lane V/C Ratio	0.313	0.005	-	-	0.096	-	-	0.126	0.032						
HCM Control Delay (s)	32.6	10.6	-	-	12.2	-	-	98.3	12.5						
HCM Lane LOS	D	B	-	-	B	-	-	F	B						
HCM 95th %ile Q(veh)	1.3	0	-	-	0.3	-	-	0.4	0.1						

Notes
- Volume exceeds capacity \$: Delay exceeds 300s +: Computation Not Defined *: All major volume in platoon

Smoke Tree Resort
2025 Total AM

9: Scottsdale Rd & Lincoln Dr
Timings

	EBL	EBT	EBR	WBL	WBT	NBL	NBT	SBL	SBT	SBR
Lane Group										
Lane Configurations	500	42	508	41	39	333	1429	55	1814	668
Traffic Volume (vph)	500	42	508	41	39	333	1429	55	1814	668
Future Volume (vph)	Split	NA	p/h-row	Split	NA	Prdt	NA	Prdt	NA	p/h-row
Turn Type	4	4	5	8	8	5	2	1	6	4
Protected Phases										
Permitted Phases	4	4	5	8	8	5	2	1	6	4
Detector Phase										
Switch Phase										
Minimum Initial (s)	7.0	7.0	7.0	7.0	7.0	10.0	10.0	5.0	10.0	7.0
Minimum Split (s)	13.0	13.0	13.0	13.0	13.0	16.7	11.0	16.0	13.0	13.0
Total Split (s)	30.0	30.0	30.0	13.0	30.0	73.0	14.0	57.0	30.0	30.0
Total Split (%)	23.1%	23.1%	23.1%	10.0%	23.1%	56.2%	10.8%	43.8%	23.1%	23.1%
Yellow Time (s)	4.0	4.0	4.0	3.6	3.6	4.0	4.7	3.3	4.7	4.0
All-Red Time (s)	1.5	1.5	1.5	2.0	2.0	1.5	1.0	2.0	1.0	1.5
Lost Time Adjust (s)	0.0	0.0	0.0	0.0	0.0	0.0	0.0	0.0	0.0	0.0
Total Lost Time (s)	5.5	5.5	5.5	5.6	5.6	5.5	5.7	5.3	5.7	5.5
Lead/Lag				Lead	Lead	Lead	Lag	Lead	Lag	Lag
Lead-Lag Optimize?	None	None	None	None	None	None	None	None	C-Max	None
Recall Mode	24.5	24.5	45.7	7.2	7.2	21.2	70.5	7.7	54.8	85.0
Act Effct Green (s)	0.19	0.19	0.35	0.06	0.06	0.16	0.54	0.06	0.42	0.65
Actuated g/C Ratio	0.95	0.95	0.94	0.47	0.43	0.66	0.59	0.59	0.94	0.68
v/c Ratio	91.5	91.4	50.9	75.4	33.9	56.7	21.8	81.5	46.5	14.7
Control Delay	0.0	0.0	0.0	0.0	0.0	0.0	0.0	0.0	0.0	0.0
Queue Delay	0.0	0.0	0.0	0.0	0.0	0.0	0.0	0.0	0.0	0.0
Total Delay	F	F	D	E	C	E	C	F	D	B
Approach Delay	71.8	71.8	46.9	28.2	28.2	38.9				
Approach LOS	E	E	D	C	C	D				
Intersection Summary										
Cycle Length: 130										
Actuated Cycle Length: 130										
Offset: 0 (0%), Referenced to phase 6, SBT, Start of Green										
Natural Cycle: 90										
Control Type: Actuated-Coordinated										
Maximum v/c Ratio: 0.95										
Intersection Signal Delay: 41.8										
Intersection Capacity Utilization 86.3%										
Analysis Period (min) 15										

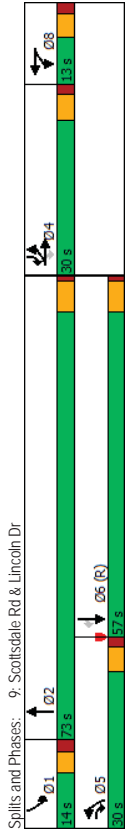

Smoke Tree Resort
2025 Total AM

9: Scottsdale Rd & Lincoln Dr
HCM 6th Signalized Intersection Summary

	EBL	EBT	EBR	WBL	WBT	NBL	NBT	SBL	SBT	SBR
Movement										
Lane Configurations	500	42	508	41	39	333	1429	43	55	1814
Traffic Volume (veh/h)	500	42	508	41	39	333	1429	43	55	1814
Future Volume (veh/h)	500	42	508	41	39	333	1429	43	55	1814
Initial Q (Ob), veh	0	0	0	0	0	0	0	0	0	0
Ped-Bike Adj(A_pbT)	1.00	1.00	1.00	1.00	1.00	1.00	1.00	1.00	1.00	1.00
Parking Bus, Adj	1.00	1.00	1.00	1.00	1.00	1.00	1.00	1.00	1.00	1.00
Work Zone On Approach	No	No	No	No	No	No	No	No	No	No
Adj Sat Flow, veh/h	1870	1870	1870	1870	1870	1870	1870	1870	1870	1870
Adj Flow Rate, veh/h	590	0	564	46	43	58	370	1588	48	61
Peak Hour Factor	0.90	0.90	0.90	0.90	0.90	0.90	0.90	0.90	0.90	0.90
Percent Heavy Veh, %	2	2	2	2	2	2	2	2	2	2
Cap, veh/h	671	0	496	95	85	85	430	2407	73	78
Arrive On Green	0.06	0.00	0.06	0.05	0.05	0.05	0.12	0.48	0.04	0.39
Sat Flow, veh/h	3563	0	1585	1781	1777	1585	3456	5093	154	1781
Grp Volume(v), veh/h	590	0	564	46	43	58	370	1061	575	61
Grp Sat Flow(s),veh/h	1781	0	1585	1781	1777	1585	1728	1702	1843	1781
Q Serve(g,s)	21.4	0.0	24.5	3.3	3.1	4.7	13.6	30.8	3.0	4.4
Cycle O Clear(g,c), s	21.4	0.0	24.5	3.3	3.1	4.7	13.6	30.8	3.0	4.4
Prop In Lane	1.00	1.00	1.00	1.00	1.00	1.00	1.00	1.00	1.00	1.00
Lane Grp Cap(c), veh/h	671	0	496	95	85	85	430	1622	878	78
V/C Ratio(X)	0.88	0.00	1.14	0.48	0.45	0.68	0.86	0.65	0.65	0.78
Avail Cap(c,a), veh/h	671	0	496	101	101	90	651	1762	954	119
HCM Platoon Ratio	0.33	0.33	0.33	1.00	1.00	1.00	1.00	1.00	1.00	1.00
Upstream Filter(0)	1.00	0.00	1.00	1.00	1.00	1.00	1.00	1.00	1.00	1.00
Uniform Delay (d), s/veh	59.5	0.0	50.4	59.8	59.7	60.4	55.8	25.9	61.5	39.3
Incr Delay (d2), s/veh	12.3	0.0	84.0	1.4	1.2	14.2	4.9	0.6	1.0	7.7
Initial Q Delay(Q3),s/veh	0.0	0.0	0.0	0.0	0.0	0.0	0.0	0.0	0.0	0.0
%ile Back(Q50%),veh/m	11.4	0.0	26.9	1.5	1.4	2.2	6.3	12.5	13.6	2.2
Unsig. Movement Delay, s/veh	71.8	0.0	134.3	61.2	60.9	74.7	60.7	26.4	69.2	59.5
LnGrp Delay(d)S/veh	E	A	F	E	E	E	E	C	C	E
LnGrp LOS	E	A	F	E	E	E	E	C	C	E
Approach Vol, veh/h	1154			147			2006			2819
Approach Delay, s/veh	102.4			66.4			32.9			51.6
Approach LOS	F			E			C			D
Timer - Assigned Phs	1	2	4	5	6	8				
Phs Duration (G+Y+Rc), s	11.0	67.7	30.0	21.7	57.0	12.6				
Change Period (Y+Rc), s	* 5.3	5.7	5.5	5.5	5.7	5.6				
Max Green Setting (Gmax), s	* 8.7	67.3	24.5	24.5	51.3	7.4				
Max Q Clear Time (g_c+I1), s	6.4	32.8	26.5	15.6	53.3	6.7				
Green Ext Time (g_e), s	0.0	2.5	0.0	0.5	0.0	0.0				
Intersection Summary										
HCM 6th Ctrl Delay	55.4									
HCM 6th LOS	E									
Notes										
User approved pedestrian interval to be less than phase max green.										
User approved volume balancing among the lanes for turning movement.										
* HCM 6th computational engine requires equal clearance times for the phases crossing the barrier.										

Smoke Tree Resort
2025 Total AM

10: Quail Run Rd & Access A
HCM 6th TWSC

Intersection	WBL	WBR	NBT	NBR	SBL	SBT
Initial Delay, s/veh	0					
Lane Configurations	W					4
Traffic Vol. veh/h	0	4	0	0	4	0
Future Vol. veh/h	0	4	0	0	4	0
Conflicting Peds. #/hr	0	0	0	0	0	0
Sign Control	Stop	Stop	Free	Free	Free	Free
RT Channelized	-	None	-	None	-	None
Storage Length	0	-	0	-	0	-
Veh in Median Storage, #	0	-	0	-	0	-
Grade, %	0	-	0	-	0	-
Peak Hour Factor	90	90	90	90	90	90
Heavy Vehicles, %	2	2	2	2	2	2
Mgmt Flow	0	4	0	0	4	0
Major/Minor	Minor1	Major1	Major1	Major2		
Conflicting Flow All	8	0	0	0	0	0
Stage 1	0	-	-	-	-	-
Stage 2	8	-	-	-	-	-
Critical Hdwy	6.42	6.22	-	-	4.12	-
Critical Hdwy Stg 1	5.42	-	-	-	-	-
Critical Hdwy Stg 2	5.42	-	-	-	-	-
Follow-up Hdwy	3.518	3.318	-	-	2.218	-
Pl Cap-1 Maneuver	1013	-	-	-	-	-
Stage 1	-	-	-	-	-	-
Stage 2	1015	-	-	-	-	-
Platoon blocked, %	-	-	-	-	-	-
Mov Cap-1 Maneuver	1013	-	-	-	-	-
Mov Cap-2 Maneuver	1013	-	-	-	-	-
Stage 1	-	-	-	-	-	-
Stage 2	1015	-	-	-	-	-
Approach	WB	NB	SB	SB		
HCM Control Delay, s						
HCM LOS						
Minor Lane/Major Mvmt	NBT	NBR	WBL	N	SBL	SBT
Capacity (veh/h)	-	-	-	-	-	-
HCM Lane V/C Ratio	-	-	-	-	-	-
HCM Control Delay (s)	-	-	-	-	-	-
HCM Lane LOS	-	-	-	-	-	-
HCM 95th %ile Q(veh)	-	-	-	-	-	-

Smoke Tree Resort
2025 Total PM

1: Mockingbird Ln & Lincoln Drive
Timings

Lane Group	EBL	EBT	WBL	WBT	NBL	NBT	SBL	SBT
Lane Configurations	4	4	4	4	4	4	4	4
Traffic Volume (vph)	267	959	27	1025	8	68	70	52
Future Volume (vph)	267	959	27	1025	8	68	70	52
Turn Type	pm+pt	NA	Perm	NA	Perm	NA	pm+pt	NA
Protected Phases	1	6	2	2	4	4	3	8
Permitted Phases	1	6	2	2	2	4	4	3
Detector Phase								
Switch Phase								
Minimum Initial (s)	4.0	15.0	15.0	15.0	7.0	7.0	4.0	7.0
Minimum Split (s)	8.0	27.0	27.0	27.0	33.5	33.5	8.0	33.5
Total Split (s)	31.0	88.0	57.0	57.0	34.0	34.0	8.0	42.0
Total Spill (%)	23.8%	67.7%	43.8%	43.8%	26.2%	26.2%	6.2%	32.3%
Yellow Time (s)	3.0	4.5	4.5	4.5	4.0	4.0	3.0	4.0
All-Red Time (s)	1.0	1.5	1.5	1.5	2.5	2.5	1.0	2.5
Lost Time Adjust (s)	0.0	0.0	0.0	0.0	0.0	0.0	0.0	0.0
Total Lost Time (s)	4.0	6.0	6.0	6.0	6.5	6.5	4.0	6.5
Lead/Lag	Lead	Lag	Lag	Lag	Lag	Lag	Lead	Lead
Lead-Lag Optimize?	Yes	Yes	Yes	Yes	Yes	Yes	Yes	Yes
Recall Mode	None	C-Max	C-Max	C-Max	None	None	None	None
Act Effct Green (s)	101.3	99.3	74.5	74.5	11.8	11.8	20.7	18.2
Actuated g/C Ratio	0.78	0.76	0.57	0.57	0.09	0.09	0.16	0.14
v/c Ratio	0.66	0.41	0.11	0.61	0.13	0.58	0.45	0.73
Control Delay	19.2	6.3	17.1	27.9	56.5	62.7	54.8	38.6
Queue Delay	0.0	0.0	0.0	0.0	0.0	0.0	0.0	0.0
Total Delay	19.2	6.3	17.1	27.9	56.5	62.7	54.8	38.6
LOS	B	A	B	C	E	E	D	D
Approach Delay		9.1		27.6		62.1		42.5
Approach LOS		A		C		E		D
Intersection Summary								
Cycle Length: 130								
Actuated Cycle Length: 130								
Offset: 0 (0%), Referenced to phase 2:WBT and 6:EBTL, Start of Green								
Natural Cycle: 90								
Control Type: Actuated-Coordinated								
Maximum v/c Ratio: 0.73								
Intersection Signal Delay: 22.0								
Intersection Capacity Utilization 72.3%								
Analysis Period (min) 15								

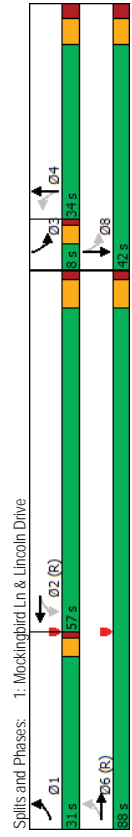

Smoke Tree Resort 2025 Total PM

1: Mockingbird Ln & Lincoln Drive HCM 6th Signalized Intersection Summary

	EBL	EBT	EBR	WBL	WBT	WBR	NBL	NBT	NBR	SBL	SBT	SBR
EBL	267	959	32	27	1025	71	8	68	21	70	52	169
EBT	267	959	32	27	1025	71	8	68	21	70	52	169
EBR	0	0	0	0	0	0	0	0	0	0	0	0
WBL	1.00	1.00	1.00	1.00	1.00	1.00	1.00	1.00	1.00	1.00	1.00	1.00
WBT	1.00	1.00	1.00	1.00	1.00	1.00	1.00	1.00	1.00	1.00	1.00	1.00
WBR	No	No	No	No	No	No	No	No	No	No	No	No
NBL	1870	1870	1870	1870	1870	1870	1870	1870	1870	1870	1870	1870
NBT	297	1066	36	30	1139	79	9	76	23	78	58	188
NBR	0.90	0.90	0.90	0.90	0.90	0.90	0.90	0.90	0.90	0.90	0.90	0.90
SBL	2	2	2	2	2	2	2	2	2	2	2	2
SBT	392	2668	87	370	2100	146	85	152	46	186	67	216
SBR	0.08	0.73	0.73	0.62	0.62	0.62	0.11	0.11	0.11	0.03	0.17	0.17
Adj Sat Flow, veh/h	1781	3507	118	512	3371	234	1134	1378	417	1781	388	1257
Adj Sat Flow, veh/h	1781	3507	118	512	3371	234	1134	1378	417	1781	388	1257
Cap, veh/h	297	540	562	30	600	618	9	0	99	78	0	246
Cap, sveh/h	1781	1777	1849	512	1777	1828	1134	0	1795	1781	0	1644
Cycle O Clear (g, c), s	7.4	15.2	15.2	3.1	25.0	25.0	12.0	0.0	6.8	4.0	0.0	18.9
Prop In Lane	1.00	1.00	1.00	1.00	1.00	1.00	1.00	0.23	1.00	0.23	1.00	0.76
V/C Ratio	0.76	0.42	0.42	0.08	0.54	0.54	0.11	0.00	0.50	0.42	0.00	0.87
Avail Cap (c), veh/h	623	1301	1354	370	1107	1139	85	0	198	186	0	282
HCM Platoon Ratio	1.00	1.00	1.00	1.00	1.00	1.00	1.00	1.00	1.00	1.00	1.00	1.00
Upstream Delay (d), s/veh	14.2	6.7	6.7	10.2	13.9	14.0	62.2	0.0	54.5	50.3	0.0	52.4
Incr Delay (d2), s/veh	0.0	0.0	0.0	0.0	0.0	0.0	0.0	0.0	2.0	1.5	0.0	10.6
%ile BackOf(50%)veh/h	4.2	5.6	5.8	0.4	10.0	10.3	0.3	0.0	3.2	0.6	0.0	8.6
Unsig. Movement Delay, s/veh	17.3	7.7	7.6	10.5	15.0	15.0	62.7	0.0	56.4	51.8	0.0	63.0
LnGp LOS	B	A	A	B	B	B	E	A	E	D	A	E
Approach Vol, veh/h	1399	1248	14.9	56.9	108	324						
Approach Delay, s/veh	9.7	14.9			56.9	60.3						
Approach LOS	A	B	B	E	E	E						
Timer - Assigned Phs	1	2	3	4	6	8						
Phs Duration (G+Y+Rc), s	14.2	87.0	8.0	20.8	101.2	28.8						
Change Period (Y+Rc), s	4.0	6.0	4.0	6.5	6.0	6.5						
Max Green Sailing (Gmax), s	27.0	51.0	4.0	27.5	82.0	35.5						
Max Q Clear Time (g_c+1), s	9.4	27.0	6.0	14.0	17.2	20.9						
Green Ext Time (p_c), s	0.8	9.7	0.0	0.4	9.8	1.3						
Intersection Summary	<p>HCW 6th Crtl Delay: 188 s</p> <p>HCW 6th LOS: B</p>											

Smoke Tree Resort 2025 Total PM

2: Quail Run Rd & Lincoln Drive Timings

	EBL	EBT	EBR	WBL	WBT	WBR	NBL	NBT	NBR	SBL	SBT	
EBL	85	980	4	1024	3	0	14	0				
EBT	85	980	4	1024	3	0	14	0				
EBR	0	0	0	0	0	0	0	0	0	0	0	
WBL	1.00	1.00	1.00	1.00	1.00	1.00	1.00	1.00	1.00	1.00	1.00	
WBT	1.00	1.00	1.00	1.00	1.00	1.00	1.00	1.00	1.00	1.00	1.00	
WBR	0	0	0	0	0	0	0	0	0	0	0	
NBL	15.0	15.0	15.0	15.0	15.0	15.0	15.0	15.0	15.0	15.0	15.0	
NBT	20.0	28.0	28.0	28.0	28.0	33.0	33.0	33.0	33.0	33.0	33.0	
NBR	20.0	94.0	74.0	74.0	74.0	36.0	36.0	36.0	36.0	36.0	36.0	
SBL	15.4%	72.3%	56.9%	56.9%	27.7%	27.7%	27.7%	27.7%	27.7%	27.7%	27.7%	
SBT	3.0	4.0	4.0	4.0	4.5	4.5	4.5	4.5	4.5	4.5	4.5	
Adm-Red Time (s)	1.0	2.5	2.5	2.5	2.5	1.5	1.5	1.5	1.5	1.5	1.5	
Lost Time Adjust (s)	0.0	0.0	0.0	0.0	0.0	0.0	0.0	0.0	0.0	0.0	0.0	
Total Lost Time (s)	4.0	6.5	6.5	6.5	6.5	6.0	6.0	6.0	6.0	6.0	6.0	
Lead/Lag	Yes	Yes	Yes	Yes	Yes	None	None	None	None	None	None	
Recall Mode	None	None	None	None	None	C-Max	C-Max	C-Max	C-Max	C-Max	C-Max	
Ad Effct Green (s)	71.7	69.2	55.2	55.2	55.2	48.3	48.3	48.3	48.3	48.3	48.3	
Actuated v/c Ratio	0.55	0.53	0.42	0.42	0.42	0.37	0.37	0.37	0.37	0.37	0.37	
v/c Ratio	0.43	0.58	0.02	0.78	0.02	0.00	0.03	0.03	0.03	0.03	0.03	
Control Delay	26.2	31.3	18.8	35.6	18.8	0.0	0.0	0.0	0.0	0.0	0.0	
Queue Delay	0.0	0.0	0.0	0.0	0.0	0.0	0.0	0.0	0.0	0.0	0.0	
Total Delay	26.2	31.3	18.8	35.6	18.8	0.0	0.0	0.0	0.0	0.0	0.0	
LOS	C	C	B	D	D	A	A	C	A	C	A	
Approach Delay												
Approach LOS												
Intersection Summary	<p>Cycle Length: 130 s</p> <p>Actuated Cycle Length: 130 s</p> <p>Offset: 0 (0%), Referenced to phase 2:NBT and 6:SBTL, Start of Green</p> <p>Natural Cycle: 70 s</p> <p>Control Type: Actuated-Coordinated</p> <p>Maximum v/c Ratio: 0.78</p> <p>Intersection Signal Delay: 31.7 s</p> <p>Intersection Capacity Utilization: 61.4%</p> <p>Analysis Period (min): 15</p>											
<p>Spills and Phases: 2: Quail Run Rd & Lincoln Drive</p> <p>Diagram showing phasing for phases 2, 4, 6, 7, 8. Phase 2 is green for 74s, phase 4 is green for 34s, phase 6 is green for 70s, and phase 7 is green for 36s.</p>												

Smoke Tree Resort
2025 Total PM

4: Smoke Tree East & Lincoln Dr
HCM 6th TWSC

Intersection												
Int Delay, s/veh	0.6											
Movement	EBT	EBR	WBL	WBT	NBL	NBR						
Lane Configurations	↕	↕	↕	↕	↕	↕						
Traffic Vol, veh/h	992	9	34	1036	18	23						
Future Vol, veh/h	992	9	34	1036	18	23						
Conflicting Peds, #/hr	0	0	0	0	0	0						
Sign Control	Free	Free	Free	Free	Stop	Stop						
RT Channelized	-	None	-	None	-	None						
Storage Length	-	-	25	-	0	-						
Veh in Median Storage, #	0	-	-	0	0	-						
Grade, %	0	-	-	-	0	0						
Peak Hour Factor	90	90	90	90	90	90						
Heavy Vehicles, %	2	2	2	2	2	2						
Mvmt Flow	1102	10	38	1151	20	26						
Major/Minor	Major1	Major2	Minor1									
Conflicting Flow All	0	0	1112	0	1759	556						
Stage 1	-	-	-	-	1107	-						
Stage 2	-	-	-	-	652	-						
Critical Hdwy	-	-	4.14	-	6.84	6.94						
Critical Hdwy Stg 1	-	-	-	-	5.84	-						
Critical Hdwy Stg 2	-	-	-	-	5.84	-						
Follow-up Hdwy	-	-	2.22	-	3.52	3.32						
Pl Cap-1 Maneuver	-	-	624	-	76	475						
Stage 1	-	-	-	-	278	-						
Stage 2	-	-	-	-	480	-						
Platoon blocked, %	-	-	-	-	-	-						
Mov Cap-1 Maneuver	-	-	624	-	71	475						
Mov Cap-2 Maneuver	-	-	-	-	180	-						
Stage 1	-	-	-	-	261	-						
Stage 2	-	-	-	-	480	-						
Approach	EB	WB	NB									
HCM Control Delay, s	0	0.4	20.6									
HCM LOS	C											
Minor Lane/Major Mvmt	NBLn1	EBT	EBR	WBL	WBT							
Capacity (veh/h)	276	-	-	624	-							
HCM Lane V/C Ratio	0.165	-	-	0.061	-							
HCM Control Delay (s)	20.6	-	-	11.1	-							
HCM Lane LOS	C	-	-	B	-							
HCM 95th %ile Q(veh)	0.6	-	-	0.2	-							

Smoke Tree Resort
2025 Total PM

5: Lincoln Medical West & Lincoln Dr
HCM 6th TWSC

Intersection												
Int Delay, s/veh	0.8											
Movement	EBT	EBR	WBL	WBT	NBL	NBR						
Lane Configurations	↕	↕	↕	↕	↕	↕						
Traffic Vol, veh/h	1008	7	21	1039	32	26						
Future Vol, veh/h	1008	7	21	1039	32	26						
Conflicting Peds, #/hr	0	0	0	0	0	0						
Sign Control	Free	Free	Free	Free	Stop	Stop						
RT Channelized	-	None	-	None	-	None						
Storage Length	-	-	25	-	0	-						
Veh in Median Storage, #	0	-	-	0	0	-						
Grade, %	0	-	-	-	0	0						
Peak Hour Factor	90	90	90	90	90	90						
Heavy Vehicles, %	2	2	2	2	2	2						
Mvmt Flow	1120	8	23	1154	36	29						
Major/Minor	Major1	Major2	Minor1									
Conflicting Flow All	0	0	1128	0	1747	564						
Stage 1	-	-	-	-	1124	-						
Stage 2	-	-	-	-	623	-						
Critical Hdwy	-	-	4.14	-	6.84	6.94						
Critical Hdwy Stg 1	-	-	-	-	5.84	-						
Critical Hdwy Stg 2	-	-	-	-	5.84	-						
Follow-up Hdwy	-	-	2.22	-	3.52	3.32						
Pl Cap-1 Maneuver	-	-	615	-	77	469						
Stage 1	-	-	-	-	272	-						
Stage 2	-	-	-	-	497	-						
Platoon blocked, %	-	-	-	-	-	-						
Mov Cap-1 Maneuver	-	-	615	-	74	469						
Mov Cap-2 Maneuver	-	-	-	-	184	-						
Stage 1	-	-	-	-	262	-						
Stage 2	-	-	-	-	497	-						
Approach	EB	WB	NB									
HCM Control Delay, s	0	0.2	24									
HCM LOS	C											
Minor Lane/Major Mvmt	NBLn1	EBT	EBR	WBL	WBT							
Capacity (veh/h)	253	-	-	615	-							
HCM Lane V/C Ratio	0.255	-	-	0.038	-							
HCM Control Delay (s)	24	-	-	11.1	-							
HCM Lane LOS	C	-	-	B	-							
HCM 95th %ile Q(veh)	1	-	-	0.1	-							

Smoke Tree Resort
2025 Total PM

6: Lincoln Medical East & Lincoln Dr
HCM 6th TWSC

Intersection												
Int Delay, s/veh												28.1
Movement	EBL	EBT	EBR	WBL	WBT	WBR	NBL	NBR	SBL	SBT	SBR	SBR
Lane Configurations		↔	↔	↔	↔	↔						
Traffic Vol, veh/h	1030	4	0	1059	0	30						
Future Vol, veh/h	1030	4	0	1059	0	30						
Conflicting Peds, #/hr	0	0	0	0	0	0						
Sign Control	Free	Free	Free	Free	Free	Free	Stop	Stop	Stop	Stop	Stop	Stop
RT Channelized	-	None	-	None	-	None	-	None	-	None	-	None
Storage Length	-	-	25	-	-	-	-	-	-	-	-	-
Veh in Median Storage, #	0	-	-	0	0	0	-	-	-	-	-	-
Grade, %	0	-	-	-	-	-	-	-	-	-	-	-
Peak Hour Factor	90	90	90	90	90	90	90	90	90	90	90	90
Heavy Vehicles, %	2	2	2	2	2	2	2	2	2	2	2	2
Mvmt Flow	1144	4	0	1177	0	33						
Major/Minor	Major1	Major2	Minor1									
Conflicting Flow All	0	0	1148	0	-	574						
Stage 1	-	-	-	-	-	-						
Stage 2	-	-	-	-	-	-						
Critical Hdwy	-	-	4.14	-	-	6.94						
Critical Hdwy Stg 1	-	-	-	-	-	-						
Critical Hdwy Stg 2	-	-	-	-	-	-						
Follow-up Hdwy	-	-	2.22	-	-	3.32						
Pot Cap-1 Maneuver	-	-	604	-	-	462						
Stage 1	-	-	-	-	-	0						
Stage 2	-	-	-	-	-	0						
Platoon blocked, %	-	-	-	-	-	-						
Mov Cap-1 Maneuver	-	-	604	-	-	462						
Mov Cap-2 Maneuver	-	-	-	-	-	-						
Stage 1	-	-	-	-	-	-						
Stage 2	-	-	-	-	-	-						
Approach	EB	WB	NB									
HCM Control Delay, s	0	0	13.4									
HCM LOS			B									
Minor Lane/Major Mvmt	NBLn1	EBL	EBR	WBL	WBT							
Capacity (veh/h)	462	-	-	604	-							
HCM Lane V/C Ratio	0.072	-	-	0.072	-							
HCM Control Delay (s)	13.4	-	-	0	-							
HCM Lane LOS	B	-	-	A	-							
HCM 95th %ile Q(veh)	0.2	-	-	0	-							

Smoke Tree Resort
2025 Total PM

7: Apartment Drwy & Lincoln Dr
HCM 6th TWSC

Intersection													
Int Delay, s/veh												28.1	
Movement	EBL	EBT	EBR	WBL	WBT	WBR	NBL	NBR	SBL	SBT	SBR	SBR	
Lane Configurations		↔	↔	↔	↔	↔							
Traffic Vol, veh/h	8993	46	7	955	10	74	3	53	8	0	38		
Future Vol, veh/h	8993	46	7	955	10	74	3	53	8	0	38		
Conflicting Peds, #/hr	0	0	0	0	0	0	0	0	0	0	0	0	
Sign Control	Free	Free	Free	Free	Free	Free	Stop	Stop	Stop	Stop	Stop	Stop	
RT Channelized	-	None	-	None	-	None	-	None	-	None	-	None	
Storage Length	25	-	-	25	-	-	-	-	-	-	-	-	
Veh in Median Storage, #	0	-	-	0	-	-	-	-	-	-	-	-	
Grade, %	0	-	-	-	-	-	-	-	-	-	-	-	
Peak Hour Factor	90	90	90	90	90	90	90	90	90	90	90	90	
Heavy Vehicles, %	2	2	2	2	2	2	2	2	2	2	2	2	
Mvmt Flow	9	1103	51	8	1061	11	82	3	59	9	0	42	
Major/Minor	Major1	Major2	Minor1										
Conflicting Flow All	1072	0	0	1154	0	0	1694	2235	577	1654	-	536	
Stage 1	-	-	-	-	-	-	1147	1147	-	1083	-	-	
Stage 2	-	-	-	-	-	-	547	1088	-	571	-	-	
Critical Hdwy	4.14	-	-	4.14	-	-	7.54	6.54	6.94	7.54	-	6.94	
Critical Hdwy Stg 1	-	-	-	-	-	-	6.54	5.54	-	6.54	-	-	
Critical Hdwy Stg 2	-	-	-	-	-	-	6.54	5.54	-	6.54	-	-	
Follow-up Hdwy	2.22	-	-	2.22	-	-	3.52	4.02	3.32	3.52	-	3.32	
Pot Cap-1 Maneuver	646	-	-	601	-	-	-60	42	460	65	0	489	
Stage 1	-	-	-	-	-	-	212	272	-	232	0	-	
Stage 2	-	-	-	-	-	-	489	290	-	473	0	-	
Platoon blocked, %	-	-	-	-	-	-	-	-	-	-	-	-	
Mov Cap-1 Maneuver	646	-	-	601	-	-	-54	41	460	52	-	489	
Mov Cap-2 Maneuver	-	-	-	-	-	-	-54	41	-	52	-	-	
Stage 1	-	-	-	-	-	-	209	268	-	229	-	-	
Stage 2	-	-	-	-	-	-	441	286	-	402	-	-	
Approach	EB	WB	NB										
HCM Control Delay, s	0.1	0.1	\$463.4										
HCM LOS			F										
Minor Lane/Major Mvmt	NBLn1	EBL	EBR	WBL	WBT	WBR	SBLn1	SBLn2					
Capacity (veh/h)	83	646	-	-	601	-	-	52	489				
HCM Lane V/C Ratio	1.74	0.014	-	-	0.013	-	-	0.171	0.086				
HCM Control Delay (s)	\$463.4	10.7	-	-	11.1	-	-	88	13.1				
HCM Lane LOS	F	B	-	-	B	-	-	F	B				
HCM 95th %ile Q(veh)	12.1	0	-	-	0	-	-	0.6	0.3				

Smoke Tree Resort
2025 Total PM
HCM 6th TWSC

Smoke Tree Resort
2025 Total PM
Timings

Intersection	4.1																		
Initial Delay, s/veh	EBL	EBT	EBR	WBL	WBT	WBR	NBL	NBT	NBR	SBL	SBT	SBR							
Movement																			
Lane Configurations	12	986	60	69	963	9	16	1	100	5	0	8							
Traffic Vol. veh/h	12	986	60	69	963	9	16	1	100	5	0	8							
Future Vol. veh/h	0	0	0	0	0	0	0	0	0	0	0	0							
Conflicting Peds. #/hr	Free	Free	Free	Free	Free	Free	Free	Free	Free	Free	Free	Free							
Sign Control	-	-	None	-	None	-	-	-	None	-	None	-							
RT Channelized	25	-	-	25	-	-	-	-	-	-	-	-							
Storage Length	-	0	-	-	0	-	-	-	-	-	-	-							
Veh in Median Storage, #	-	0	-	-	0	-	-	-	-	-	-	-							
Grade, %	-	0	-	-	0	-	-	-	-	-	-	-							
Peak Hour Factor	90	90	90	90	90	90	90	90	90	90	90	90							
Heavy Vehicles, %	2	2	2	2	2	2	2	2	2	2	2	2							
Mgmt Flow	13	10%	67	77	1059	10	18	1	111	6	0	9							
Major/Minor	Major1	Major2						Minor1						Minor2					
Conflicting Flow All	1069	0	0	1163	0	0	1840	2379	582	1793	-	535							
Stage 1	-	-	-	-	-	-	-	1156	1156	-	1218	-							
Stage 2	-	-	-	-	-	-	-	684	1223	-	575	-							
Critical Hwy	4.14	-	-	4.14	-	-	7.54	6.54	6.94	7.54	-	6.94							
Critical Hwy Slg 1	-	-	-	-	-	-	-	6.54	5.54	-	6.54	-							
Critical Hwy Slg 2	-	-	-	-	-	-	-	6.54	5.54	-	6.54	-							
Follow-up Hwy	2.22	-	-	2.22	-	-	3.52	4.02	3.32	3.52	-	3.32							
Pl Cap-1 Maneuver	648	-	-	596	-	-	47	34	456	51	0	490							
Stage 1	-	-	-	-	-	-	-	209	269	-	191	0							
Stage 2	-	-	-	-	-	-	-	405	250	-	470	0							
Platoon blocked, %	-	-	-	-	-	-	-	-	-	-	-	-							
Mov Cap-1 Maneuver	648	-	-	596	-	-	41	29	456	33	-	490							
Mov Cap-2 Maneuver	-	-	-	-	-	-	-	41	29	-	33	-							
Stage 1	-	-	-	-	-	-	-	205	264	-	187	-							
Stage 2	-	-	-	-	-	-	-	346	218	-	347	-							
Approach	EB	WB	NB	WB	NB	SB	SB	SB	SB	SB	SB	SB							
HCM Control Delay, s	0.1	0.8	0.8	0.8	0.8	62.9	59.6	59.6	59.6	59.6	59.6	59.6							
HCM LOS	F	F	F	F	F	F	F	F	F	F	F	F							
Minor Lane/Major Mvmt	NBLn1	EBL	EBT	EBR	WBL	WBT	WBR	SBLn1	SBLn2	SBLn2	SBLn2	SBR							
Capacity (veh/h)	182	648	-	-	596	-	-	33	490	-	-	-							
HCM Lane V/C Ratio	0.714	0.021	-	-	0.129	-	-	0.168	0.018	-	-	-							
HCM Control Delay (s)	62.9	10.7	-	-	11.9	-	-	135	12.5	-	-	-							
HCM Lane LOS	F	B	-	-	B	-	-	F	B	-	-	-							
HCM 95th %ile Q(veh)	4.5	0.1	-	-	0.4	-	-	0.5	0.1	-	-	-							

Smoke Tree Resort
2025 Total PM
Timings

Lane Group	EBL	EBT	EBR	WBL	WBT	WBR	NBL	NBT	NBR	SBL	SBT	SBR
Lane Configurations	EBL	EBT	EBR	WBL	WBT	WBR	NBL	NBT	NBR	SBL	SBT	SBR
Traffic Volume (vph)	571	61	482	61	68	461	1762	66	1702	546	1702	546
Future Volume (vph)	571	61	482	61	68	461	1762	66	1702	546	1702	546
Turn Type	Split	NA	pm+ov	Split	NA	NA	Prot	NA	Prot	NA	pm+ov	NA
Protected Phases	4	4	5	8	8	5	2	1	6	4	4	4
Permitted Phases	4	4	5	8	8	5	2	1	6	4	4	4
Detector Phase	4	4	5	8	8	5	2	1	6	4	4	4
Switch Phase	4	4	5	8	8	5	2	1	6	4	4	4
Minimum Initial (s)	7.0	7.0	7.0	7.0	7.0	7.0	7.0	10.0	5.0	10.0	7.0	7.0
Minimum Split (s)	13.0	13.0	13.0	13.0	13.0	13.0	13.0	16.7	11.0	16.0	13.0	13.0
Total Split (s)	30.0	30.0	30.0	30.0	30.0	30.0	30.0	73.0	14.0	57.0	30.0	30.0
Total Split (%)	23.1%	23.1%	23.1%	10.0%	10.0%	23.1%	56.2%	10.8%	43.8%	23.1%	43.8%	23.1%
Yellow Time (s)	4.0	4.0	4.0	3.6	3.6	4.0	4.7	3.3	4.7	4.0	4.0	4.0
All-Red Time (s)	1.5	1.5	1.5	2.0	2.0	1.5	1.0	2.0	1.0	1.5	1.5	1.5
Lost Time Adjust (s)	0.0	0.0	0.0	0.0	0.0	0.0	0.0	0.0	0.0	0.0	0.0	0.0
Total Lost Time (s)	5.5	5.5	5.5	5.6	5.6	5.5	5.7	5.3	5.7	5.5	5.5	5.5
Lead/Lag	Lead	Lead	Lead	Lead	Lead	Lead	Lead	Lead	Lead	Lead	Lead	Lag
Lead-Lag Optimize?	None	None	None	None	None	None	None	None	None	None	None	None
Recall Mode	None	None	None	None	None	None	None	None	None	None	None	None
Act Effct Green (s)	24.5	24.5	47.1	7.3	7.3	22.6	70.3	8.0	53.3	83.5	83.5	83.5
Actuated g/C Ratio	0.19	0.19	0.36	0.06	0.06	0.17	0.54	0.06	0.41	0.64	0.64	0.64
v/C Ratio	1.10	1.10	0.87	0.69	0.62	0.86	0.74	0.67	0.91	0.57	0.57	0.57
Control Delay	129.9	129.2	39.6	92.9	39.0	66.9	25.4	88.3	43.9	13.3	13.3	13.3
Queue Delay	0.0	0.0	0.0	0.0	0.0	0.0	0.0	0.0	0.0	0.0	0.0	0.0
Total Delay	129.9	129.2	39.6	92.9	39.0	66.9	25.4	88.3	43.9	13.3	13.3	13.3
LOS	F	F	D	F	D	E	C	F	D	D	B	B
Approach Delay	F	F	D	F	D	E	C	F	D	D	B	B
Approach LOS	F	F	D	F	D	E	C	F	D	D	B	B
Intersection Summary												
Cycle Length: 130												
Actuated Cycle Length: 130												
Offset: 0 (0%), Referenced to phase 6.SBT, Start of Green												
Natural Cycle: 100												
Control Type: Actuated-Coordinated												
Maximum v/c Ratio: 1.10												
Intersection Signal Delay: 46.9												
Intersection Capacity Utilization 87.9%												
Analysis Period (min) 15												

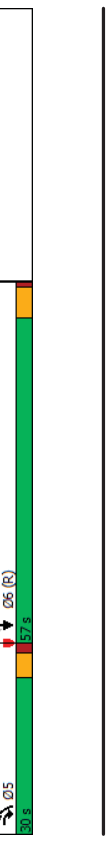

Smoke Tree Resort
2025 Total PM

9: Scottsdale Rd & Lincoln Dr
HCM 6th Signalized Intersection Summary

Movement	EBL	EBT	EBR	WBL	WBT	WBR	NBL	NBT	NBR	SBL	SBT	SBR
Lane Configurations	↔	↔	↔	↔	↔	↔	↔	↔	↔	↔	↔	↔
Traffic Volume (veh/h)	571	61	482	61	68	78	461	1762	50	66	1702	546
Future Volume (veh/h)	571	61	482	61	68	78	461	1762	50	66	1702	546
Initial Q (Q _{bb}), veh	0	0	0	0	0	0	0	0	0	0	0	0
Ped-Bike Adj(A_pb1)	1.00	1.00	1.00	1.00	1.00	1.00	1.00	1.00	1.00	1.00	1.00	1.00
Parking Bus, Adj	1.00	1.00	1.00	1.00	1.00	1.00	1.00	1.00	1.00	1.00	1.00	1.00
Work Zone On Approach	No	No	No	No	No	No	No	No	No	No	No	No
Adj Sat Flow, veh/h	1870	1870	1870	1870	1870	1870	1870	1870	1870	1870	1870	1870
Adj Flow Rate, veh/h	683	0	536	68	76	87	512	1958	56	73	1891	607
Peak Hour Factor	0.90	0.90	0.90	0.90	0.90	0.90	0.90	0.90	0.90	0.90	0.90	0.90
Percent Heavy Veh, %	2	2	2	2	2	2	2	2	2	2	2	2
Cap, veh/h	671	0	559	101	101	90	568	2594	74	93	2015	924
Arrive On Green	0.06	0.00	0.06	0.06	0.06	0.06	0.16	0.51	0.51	0.05	0.39	0.39
Sat Flow, veh/h	3563	0	1585	1781	1777	1585	3456	5102	146	1781	5106	1585
Grp Volume(v), veh/h	683	0	536	68	76	87	512	1305	709	73	1891	607
Grp Sat Flow(s), veh/h	1781	0	1585	1781	1777	1585	1728	1702	1844	1781	1702	1585
Q Serve(g_s), s	24.5	0.0	24.5	4.9	5.5	7.1	18.9	39.7	39.9	5.3	46.3	33.6
Cycle Q Clear(g_c), s	24.5	0.0	24.5	4.9	5.5	7.1	18.9	39.7	39.9	5.3	46.3	33.6
Prop In Lane	1.00	1.00	1.00	1.00	1.00	1.00	1.00	1.00	1.00	1.00	1.00	1.00
Lane Grp Cap(c), veh/h	671	0	559	101	101	90	568	1731	938	93	2015	924
V/C Ratio(x)	1.02	0.00	0.96	0.67	0.75	0.96	0.90	0.75	0.76	0.79	0.94	0.66
Avail Cap(c), veh/h	671	0	559	101	101	90	651	1762	955	119	2015	924
HCM Platoon Ratio	0.33	0.33	0.33	1.00	1.00	1.00	1.00	1.00	1.00	1.00	1.00	1.00
Upstream Filter(i)	1.00	0.00	1.00	1.00	1.00	1.00	1.00	1.00	1.00	1.00	1.00	1.00
Uniform Delay (d), s/veh	61.0	0.0	46.0	60.1	60.4	61.2	53.3	25.5	25.5	60.9	37.8	18.3
Incr Delay (d2), s/veh	39.1	0.0	21.7	13.1	24.0	82.2	13.6	1.6	3.0	17.6	10.0	3.6
%ile BackOf(50%),veh/m	15.4	0.0	20.2	2.6	3.1	4.9	9.3	16.2	17.9	2.8	20.8	19.6
Unsig. Movement Delay, s/veh	100.1	0.0	73.8	73.2	84.4	143.4	66.9	27.1	28.5	78.5	47.8	22.0
LnGrp Delay(d),s/veh	F	A	E	E	F	F	E	C	C	E	D	C
LnGrp LOS	F	A	E	E	F	F	E	C	C	E	D	C
Approach Vol, veh/h	1219			231			2526				2571	
Approach Delay, s/veh	88.5			103.3			35.6				42.6	
Approach LOS	F			F			D				D	
Timer - Assigned PHS	1	2	2	4	5	6	8					
Phs Duration (G+Y+Rc), s	12.1	71.8		30.0	26.8	57.0	13.0					
Change Period (Y+Rc), s	* 5.3	5.7		5.5	5.5	5.7	5.6					
Max Green Stalling (Gmax), s	* 8.7	67.3		24.5	24.5	51.3	7.4					
Max Q Clear Time (g_c+1), s	7.3	41.9		26.5	20.9	48.3	9.1					
Green Ext Time (g_e), s	0.0	3.3		0.0	0.5	1.5	0.0					

Intersection Summary
HCM 6th Ctrl Delay 50.6
HCM 6th LOS D

Notes
User approved pedestrian interval to be less than phase max green.
User approved volume balancing among the lanes for turning movement.
* HCM 6th computational engine requires equal clearance times for the phases crossing the barrier.

Smoke Tree Resort
2025 Total PM

10: Quail Run Rd & Access A
HCM 6th TWSC

Intersection	0					
In Delay, s/veh	WBL	WBR	NBT	NBR	SBL	SBT
Movement	↔	↔	↔	↔	↔	↔
Lane Configurations	↔	↔	↔	↔	↔	↔
Traffic Vol, veh/h	0	6	0	0	5	0
Future Vol, veh/h	0	6	0	0	5	0
Conflicting Peds, #/hr	0	0	0	0	0	0
Sign Control	Stop	Stop	Free	Free	Free	Free
RT Channelized	-	None	-	None	-	None
Storage Length	0	-	-	-	-	-
Veh in Median Storage, #	0	-	0	-	-	0
Grade, %	0	-	0	-	-	0
Peak Hour Factor	90	90	90	90	90	90
Heavy Vehicles, %	2	2	2	2	2	2
Mvmt Flow	0	7	0	0	6	0
Major/Minor	Minor1	Major1	Major1	Major2		
Conflicting Flow All	12	0	0	0	0	0
Stage 1	0	-	-	-	-	-
Stage 2	12	-	-	-	-	-
Critical Hdwy	6.42	6.22	-	-	4.12	-
Critical Hdwy Stg 1	5.42	-	-	-	-	-
Critical Hdwy Stg 2	5.42	-	-	-	-	-
Follow-up Hdwy	3.518	3.318	-	-	2.218	-
Pl Cap-1 Maneuver	1008	-	-	-	-	-
Stage 1	-	-	-	-	-	-
Stage 2	1011	-	-	-	-	-
Platoon blocked, %	-	-	-	-	-	-
Mov Cap-1 Maneuver	1008	-	-	-	-	-
Mov Cap-2 Maneuver	1008	-	-	-	-	-
Stage 1	-	-	-	-	-	-
Stage 2	1011	-	-	-	-	-
Approach	WB	NB	SB	SB		
HCM Control Delay, s	-	-	0			
HCM LOS						
Minor Lane/Major Mvmt	NBT	NBR/WB Ln1	SBL	SBT		
Capacity (veh/h)	-	-	-	-	-	-
HCM Lane V/C Ratio	-	-	-	-	-	-
HCM Control Delay (s)	-	-	-	-	-	-
HCM Lane LOS	-	-	-	-	-	-
HCM 95th %tile Q(veh)	-	-	-	-	-	-

11/16/2018
CivTech BR
Synchro 10 Report
Page 13

APPENDIX I

QUEUE STORAGE ANALYSIS

**Signalized Intersection
2025**

Average Vehicle Length (ft): 25

Cycles: 2

Intersection Cycle Length (sec): 120

Equation Used: storage length = 2 x (vehicles/hour)/(cycles/hour) x average vehicle length

Intersection	Approach	AM Peak (veh/hr)	Midday Peak	PM Peak (veh/hr)	Max vehs per 2 cycles	Max trucks per 2 cycles	Storage Length
Mockingbird Lane & Lincoln Dr	NB Left	6	0	8	1	0	25'
	SB Left	86	0	70	6	0	150'
	EB Left	242	0	267	18	0	450'
	WB Left	25	0	27	2	0	50'
	NB Right	25	0	21	2	0	50'
	SB Right	253	0	169	17	0	425'
	EB Right	33	0	32	3	0	75'
	WB Right	48	0	71	5	0	125'
Quail Run Rd & Lincoln Dr	NB Left	2	0	3	1	0	25'
	SB Left	26	0	14	2	0	50'
	EB Left	115	0	85	8	0	200'
	WB Left	5	0	4	1	0	25'
	NB Right	10	0	6	1	0	25'
	SB Right	66	0	93	7	0	175'
	EB Right	4	0	3	1	0	25'
	WB Right	12	0	25	2	0	50'
Scottsdale Rd & Lincoln Dr	NB Left	333	0	461	31	0	775'
	SB Left	55	0	66	5	0	125'
	EB Left	500	0	571	39	0	975'
	WB Left	41	0	61	5	0	125'
	NB Right	43	0	50	4	0	100'
	SB Right	668	0	546	45	0	1125'
	EB Right	508	0	482	34	0	850'
	WB Right	52	0	78	6	0	150'

Unsignalized Intersection
2025

Average Vehicle Length (ft): 25

Equation Used: storage length = 2 x (vehicles/hour)/(60 minutes/hour) x average vehicle length

Intersection	Approach	AM Peak (veh/hr)	Midday Peak	PM Peak (veh/hr)	Veh per 2 minutes	Trucks per 2 minutes	Storage Length
Smoke Tree Drwy West & Lincoln Dr	NB Left	0	0	0	0	0	0'
	SB Left	0	0	0	0	0	0'
	EB Left	0	0	0	0	0	0'
	WB Left	0	0	0	0	0	0'
	NB Right	6	0	11	1	0	25'
	SB Right	0	0	0	0	0	0'
	EB Right	10	0	10	1	0	25'
	WB Right	0	0	0	0	0	0'
Smoke Tree Drwy East & Lincoln Dr	NB Left	15	0	18	1	0	25'
	SB Left	0	0	0	0	0	0'
	EB Left	0	0	0	0	0	0'
	WB Left	27	0	34	2	0	50'
	NB Right	14	0	23	1	0	25'
	SB Right	0	0	0	0	0	0'
	EB Right	7	0	9	1	0	25'
	WB Right	0	0	0	0	0	0'
Medical Drwy West & Lincoln Dr	NB Left	6	0	30	2	0	50'
	SB Left	0	0	0	0	0	0'
	EB Left	0	0	0	0	0	0'
	WB Left	42	0	21	2	0	50'
	NB Right	9	0	26	1	0	25'
	SB Right	0	0	0	0	0	0'
	EB Right	18	0	7	1	0	25'
	WB Right	0	0	0	0	0	0'
Medical Drwy East & Lincoln Dr	NB Left	0	0	2	1	0	25'
	SB Left	0	0	0	0	0	0'
	EB Left	0	0	0	0	0	0'
	WB Left	6	0	0	1	0	25'
	NB Right	9	0	30	2	0	50'
	SB Right	0	0	0	0	0	0'
	EB Right	11	0	4	1	0	25'
	WB Right	0	0	0	0	0	0'
Apartment Drwy & Lincoln Dr	NB Left	56	0	74	3	0	75'
	SB Left	6	0	8	1	0	25'
	EB Left	29	0	8	1	0	25'
	WB Left	20	0	7	1	0	25'
	NB Right	33	0	53	2	0	50'
	SB Right	14	0	38	2	0	50'
	EB Right	38	0	46	2	0	50'
	WB Right	11	0	10	1	0	25'
AJ's Drwy & Lincoln Dr	NB Left	7	0	16	1	0	25'
	SB Left	5	0	5	1	0	25'
	EB Left	3	0	12	1	0	25'
	WB Left	48	0	69	3	0	75'
	NB Right	46	0	100	4	0	100'
	SB Right	14	0	8	1	0	25'
	EB Right	60	0	60	2	0	50'
	WB Right	9	0	9	1	0	25'
	NB Left	0	0	0	0	0	0'

Unsignalized Intersection
2025

Average Vehicle Length (ft): 25

Equation Used: storage length = 2 x (vehicles/hour)/(60 minutes/hour) x average vehicle length

Intersection	Approach	AM Peak (veh/hr)	Midday Peak	PM Peak (veh/hr)	Veh per 2 minutes	Trucks per 2 minutes	Storage Length
Quail Run Rd & Access A	SB Left	4	0	5	1	0	25'
	EB Left	0	0	0	0	0	0'
	WB Left	0	0	0	0	0	0'
	NB Right	0	0	0	0	0	0'
	SB Right	0	0	0	0	0	0'
	EB Right	0	0	0	0	0	0'
	WB Right	4	0	6	1	0	25'

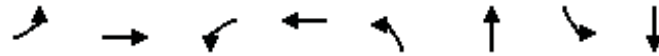

Lane Group	EBL	EBT	WBL	WBT	NBL	NBT	SBL	SBT
Lane Group Flow (vph)	269	1210	28	1132	7	69	96	388
v/c Ratio	0.67	0.50	0.13	0.64	0.09	0.24	0.32	0.85
Control Delay	22.4	12.1	23.4	30.6	44.3	30.2	40.0	50.6
Queue Delay	0.0	0.0	0.0	0.0	0.0	0.0	0.0	0.0
Total Delay	22.4	12.1	23.4	30.6	44.3	30.2	40.0	50.6
Queue Length 50th (ft)	79	237	17	523	5	31	65	231
Queue Length 95th (ft)	196	380	m43	#637	18	68	101	317
Internal Link Dist (ft)		105		1255		475		337
Turn Bay Length (ft)	150		95		80		135	
Base Capacity (vph)	459	2401	217	1773	145	523	304	666
Starvation Cap Reductn	0	0	0	0	0	0	0	0
Spillback Cap Reductn	0	0	0	0	0	0	0	0
Storage Cap Reductn	0	0	0	0	0	0	0	0
Reduced v/c Ratio	0.59	0.50	0.13	0.64	0.05	0.13	0.32	0.58

Intersection Summary

95th percentile volume exceeds capacity, queue may be longer.

Queue shown is maximum after two cycles.

m Volume for 95th percentile queue is metered by upstream signal.

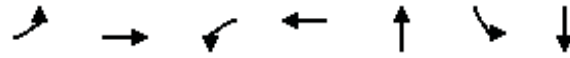

Lane Group	EBL	EBT	WBL	WBT	NBT	SBL	SBT
Lane Group Flow (vph)	128	1246	6	1053	13	29	73
v/c Ratio	0.55	0.70	0.05	0.77	0.02	0.05	0.09
Control Delay	28.6	35.6	22.8	38.4	0.1	28.4	0.2
Queue Delay	0.0	0.0	0.0	0.0	0.0	0.0	0.0
Total Delay	28.6	35.6	22.8	38.4	0.1	28.4	0.2
Queue Length 50th (ft)	73	522	3	402	0	15	0
Queue Length 95th (ft)	120	598	12	426	0	42	0
Internal Link Dist (ft)		1255		49	137		291
Turn Bay Length (ft)	25		25				
Base Capacity (vph)	297	2382	149	1834	689	561	798
Starvation Cap Reductn	0	0	0	0	0	0	0
Spillback Cap Reductn	0	0	0	0	0	0	0
Storage Cap Reductn	0	0	0	0	0	0	0
Reduced v/c Ratio	0.43	0.52	0.04	0.57	0.02	0.05	0.09
Intersection Summary							

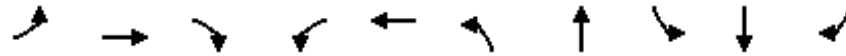

Lane Group	EBL	EBT	EBR	WBL	WBT	NBL	NBT	SBL	SBT	SBR
Lane Group Flow (vph)	300	303	564	46	101	370	1636	61	2016	742
v/c Ratio	0.95	0.95	0.94	0.47	0.43	0.66	0.59	0.59	0.94	0.68
Control Delay	91.5	91.4	50.9	75.4	33.9	56.7	21.8	81.5	46.5	14.7
Queue Delay	0.0	0.0	0.0	0.0	0.0	0.0	0.0	0.0	0.0	0.0
Total Delay	91.5	91.4	50.9	75.4	33.9	56.7	21.8	81.5	46.5	14.7
Queue Length 50th (ft)	265	268	299	38	18	148	347	51	613	300
Queue Length 95th (ft)	#454	#458	#515	81	48	200	397	99	#745	455
Internal Link Dist (ft)		389			130		477		335	
Turn Bay Length (ft)	175			90		275		185		
Base Capacity (vph)	316	319	640	100	238	646	2750	118	2143	1094
Starvation Cap Reductn	0	0	0	0	0	0	0	0	0	0
Spillback Cap Reductn	0	0	0	0	0	0	0	0	0	0
Storage Cap Reductn	0	0	0	0	0	0	0	0	0	0
Reduced v/c Ratio	0.95	0.95	0.88	0.46	0.42	0.57	0.59	0.52	0.94	0.68

Intersection Summary

95th percentile volume exceeds capacity, queue may be longer.
Queue shown is maximum after two cycles.

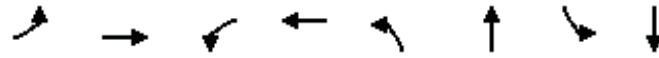

Lane Group	EBL	EBT	WBL	WBT	NBL	NBT	SBL	SBT
Lane Group Flow (vph)	297	1102	30	1218	9	99	78	246
v/c Ratio	0.66	0.41	0.11	0.61	0.13	0.58	0.45	0.73
Control Delay	19.2	6.3	17.1	27.9	56.5	62.7	54.8	38.6
Queue Delay	0.0	0.0	0.0	0.0	0.0	0.0	0.0	0.0
Total Delay	19.2	6.3	17.1	27.9	56.5	62.7	54.8	38.6
Queue Length 50th (ft)	79	152	16	563	7	72	58	99
Queue Length 95th (ft)	183	220	m36	642	25	128	101	186
Internal Link Dist (ft)		105		1255		475		337
Turn Bay Length (ft)	150		95		80		135	
Base Capacity (vph)	527	2691	276	2010	160	389	174	539
Starvation Cap Reductn	0	0	0	0	0	0	0	0
Spillback Cap Reductn	0	0	0	0	0	0	0	0
Storage Cap Reductn	0	0	0	0	0	0	0	0
Reduced v/c Ratio	0.56	0.41	0.11	0.61	0.06	0.25	0.45	0.46

Intersection Summary

m Volume for 95th percentile queue is metered by upstream signal.

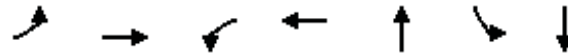

Lane Group	EBL	EBT	WBL	WBT	NBT	SBL	SBT
Lane Group Flow (vph)	94	1092	4	1166	10	16	103
v/c Ratio	0.43	0.58	0.02	0.78	0.02	0.03	0.14
Control Delay	26.2	31.3	18.8	35.6	0.0	31.3	0.4
Queue Delay	0.0	0.0	0.0	0.0	0.0	0.0	0.0
Total Delay	26.2	31.3	18.8	35.6	0.0	31.3	0.4
Queue Length 50th (ft)	49	400	2	433	0	9	0
Queue Length 95th (ft)	86	477	8	458	0	29	0
Internal Link Dist (ft)		1255		49	187		291
Turn Bay Length (ft)	25		25				
Base Capacity (vph)	292	2382	216	1831	638	519	748
Starvation Cap Reductn	0	0	0	0	0	0	0
Spillback Cap Reductn	0	0	0	0	0	0	0
Storage Cap Reductn	0	0	0	0	0	0	0
Reduced v/c Ratio	0.32	0.46	0.02	0.64	0.02	0.03	0.14
Intersection Summary							

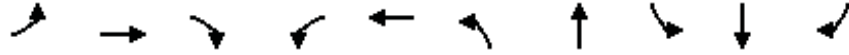

Lane Group	EBL	EBT	EBR	WBL	WBT	NBL	NBT	SBL	SBT	SBR
Lane Group Flow (vph)	349	353	536	68	163	512	2014	73	1891	607
v/c Ratio	1.10	1.10	0.87	0.69	0.62	0.86	0.74	0.67	0.91	0.57
Control Delay	129.9	129.2	39.6	92.9	39.0	66.9	25.4	88.3	43.9	13.3
Queue Delay	0.0	0.0	0.0	0.0	0.0	0.0	0.0	0.0	0.0	0.0
Total Delay	129.9	129.2	39.6	92.9	39.0	66.9	25.4	88.3	43.9	13.3
Queue Length 50th (ft)	~351	~354	272	57	33	214	480	61	556	229
Queue Length 95th (ft)	#555	#560	#429	#131	71	278	542	#127	#664	338
Internal Link Dist (ft)		389			130		477		335	
Turn Bay Length (ft)	175			90		275		185		
Base Capacity (vph)	316	320	640	100	267	646	2740	118	2083	1056
Starvation Cap Reductn	0	0	0	0	0	0	0	0	0	0
Spillback Cap Reductn	0	0	0	0	0	0	0	0	0	0
Storage Cap Reductn	0	0	0	0	0	0	0	0	0	0
Reduced v/c Ratio	1.10	1.10	0.84	0.68	0.61	0.79	0.74	0.62	0.91	0.57

Intersection Summary

~ Volume exceeds capacity, queue is theoretically infinite.
Queue shown is maximum after two cycles.

95th percentile volume exceeds capacity, queue may be longer.
Queue shown is maximum after two cycles.

APPENDIX J

SIGHT DISTANCE ANALYSIS

Smoke Tree Resort

Location: East Access

Sight Distance Analysis

Assumptions and/or Given

<i>Elements of Design from AASHTO</i>	<i>6th Edition</i>	<i>AASHTO Ref</i>
Driver Eye Height		
Passenger Vehicle	3.50 ft	§3.2.6, p 3-14
Truck	7.60 ft	§3.2.6, p 3-14
Object Height		
Stopping Sight Distance	2.00 ft	§3.2.6, p 3-14
Passing Sight Distance	3.50 ft	§3.2.6, p 3-14
Vehicle Height	4.25 ft	§3.2.6, p 3-14
Driver Eye Location		
From Edge of Major Rd Traveled Way	14.50 ft	9.5.3, B1
Deceleration Rate (a)		
Passenger Vehicle	11.20 ft/sec ²	§3.2.2, p 3-3
Truck	N/A ft	
Brake reaction time (t)	2.50 sec	§3.2.2, p 3-4

Site Specific Data (Bike & turn lanes are outside traveled way and are not considered)

Major Street Design Speed (V _{major})	40 MPH	
Grades - Approaching Minor Street from: (– = approaching downhill)		
Left (G _L)	%	
Right (G _R)	%	
Approach Grade Adjustment Factor	Left 1.0	Tbl 9-4, p 9-35
	Right 1.0	
Major Road Through Lanes on Each Approach	2.0 (Use 1 for RI/RO/[LI] only)	
Median Width (in "Lane Equivalents")	12.0 (Use 0 for RI/RO/[LI] only)	
Minor Road Approach Upgrade, if >3%	%	
Minor Road Access (check restricted)		
	LI	LO/Th RO

Stopping Sight Distance = Brake Reaction Distance + Braking Distance

<u>Neglecting Effect of Grade</u>	Eq 3-2, p 3-4
$d = 1.47Vt + 1.075 \frac{V^2}{a}$	
Calculated d= 300.6 ft	
Design d= 305 ft	

<u>With Effect of Grade</u>	Eq 3-3, p 3-5
$d = 1.47Vt + \frac{V^2}{30((\frac{a}{32.2}) \pm G)}$	
Calculated d= 300.3 ft - left	
305 ft - right	
Design d= 300.3 ft - left	
305 ft - right	

SSD's do not consider design for truck operations, since better visibility is considered to offset longer braking distance. §3.2.2, p 3-6



Smoke Tree Resort

Location: East Access

Sight Distance Analysis

Intersection Sight Distances

Case B—Intersections with Stop Control on the Minor Road

AASHTO Ref
§9.5.3, p 9-36

Case B1—Left Turn from the Minor Road

§9.5.3, p 9-36

Design Vehicle	Time Gap (t _g)	
Passenger Car	7.5 sec	Tbl 9-5, p 9-37
Single-Unit Truck	9.5 sec	Tbl 9-5, p 9-37
Combination Truck	11.5 sec	Tbl 9-5, p 9-37

Time gap adjustments

Add'l lanes to cross (1 st is assumed)		
Passenger Car	0.5 sec	See Notes
Trucks	0.7 sec	below
Minor Approach Upgrade (Per each 1%>3%)	0.2 sec	Tbl 9-5, p 9-37

Site data

Major Road Lanes on Left Approach	2.0	§9.5.3, p 9-37
Minor Road Approach Upgrade, if >3%	0 %	§9.5.3, p 9-37

Time Gap based on site data

Design Vehicle Gap+Adj for Approach Grade>3%+Adjs for Add'l Lanes & Median

Passenger Car	14.0 sec
Single-Unit Truck	18.6 sec
Combination Truck	20.6 sec

ISD to left & right along Major Road ISD=1.47V_{major}t_g (ft) Eq 9-1, p 9-37

	ISD to Left and Right
Passenger Car	calculated ISD= 823.2 ft design ISD= 825 ft
Single-Unit Truck	calculated ISD= 1093.7 ft design ISD= 1095 ft
Combination Truck	calculated ISD= 1211.3 ft design ISD= 1215 ft



Smoke Tree Resort
Location: East Access

Sight Distance Analysis

Intersection Sight Distances (cont'd)

		<i>AASHTO Ref</i>
<u>Case B2—Right Turn from the Minor Road</u>		§9.5.3, p 9-40
&		
<u>Case B3—Crossing Maneuver from the Minor Road</u>		§9.5.3, p 9-43
Design Vehicle	Time Gap (t_g)	
Passenger Car	6.5 sec	Tbl 9-7, p 9-40
Single-Unit Tuck	8.5 sec	Tbl 9-7, p 9-40
Combination Truck	10.5 sec	Tbl 9-7, p 9-40
Time gap adjustments - Case B-3 Only*		
Add'l lanes to cross (1 st is assumed)		
Passenger Car	0.5 sec	See Notes
Trucks	0.7 sec	below
Minor Approach Upgrade (Per each 1%>3%)	0.1 sec	Tbl 9-7, p 9-40
Site data		
Major Road Lanes on Left Approach	2.0	§9.5.3, p 9-40
Minor Road Approach Upgrade, if >3%	0 %	§9.5.3, p 9-40

Time Gap based on site data (sec)	<u>B2 & B3 B3 Only</u>	
<i>Design Vehicle Gap+Adj for Approach Grade>3%(+Adjs for Add'l Lanes & Median for B3)</i>		
Passenger Car	13.0	13.5
Single-Unit Tuck	17.6	18.3
Combination Truck	19.6	20.3

ISD to left (B2/B3) & right (B3) along Major Rd $ISD=1.47V_{major}t_g$ (ft) Eq 9-1, p 9-37

		<u>ISD to Left ISD to right</u>	
		<u>(B2 & B3)</u>	<u>(B3 Only)</u>
Passenger Car	calculated ISD=	764.4	793.8
	design ISD=	765	795
Single-Unit Tuck	calculated ISD=	1034.9	1076.0
	design ISD=	1035	1080
Combination Truck	calculated ISD=	1152.5	1193.6
	design ISD=	1155	1195

*Number of major road lanes is irrelevant in Case B2.

The differences between Case B1 and Cases B2 & B3 are reduced time gaps and time gap adjustment for the minor approach upgrade. §9.5.3, p 9-43



Smoke Tree Resort
Location: East Access

Sight Distance Analysis

Intersection Sight Distances (cont'd)

		<i>AASHTO Ref</i>
<u>Case F—Left Turns from the Major Road</u>		§9.5.3, p 9-51
Design Vehicle	Time Gap (t_g)	
Passenger Car	5.5 sec	bl 9-13, p 9-51
Single-Unit Tuck	6.5 sec	bl 9-13, p 9-51
Combination Truck	7.5 sec	bl 9-13, p 9-51
Time gap adjustments		
Add'l lanes to cross (1 assumed)		
Passenger Car	0.5 sec	See Notes to
Trucks	0.7 sec	bl 9-13, p 9-51
Site data		
Opposing Lanes (adj'd for x-wide median)	13.0	
Time Gap based on site data		
<i>Design Vehicle Gap+Adj for Add'l Opposing Lanes</i>		
Passenger Car	12.0 sec	
Single-Unit Tuck	15.6 sec	
Combination Truck	16.6 sec	
ISD to front along Major Road	$ISD=1.47V_{major}t_g$ (ft)	Eq 9-1, p 9-37
Passenger Car	calculated ISD= 705.6 ft	
	design ISD= 710 ft	
Single-Unit Tuck	calculated ISD= 917.3 ft	
	design ISD= 920 ft	
Combination Truck	calculated ISD= 976.1 ft	
	design ISD= 980 ft	

The differences between Case F and Cases B1, B2 & B3 are reduced time gaps and no time gap adjustment for any minor approach upgrade. §9.5.3, p 9-43

SIGHT DISTANCE SUMMARY

Sight Distance Type	Governing Case	Car	SU Truck	Combo Truck
Stopping				
Without effect of grade		305	N/A	N/A
With effect of grade on left		305	N/A	N/A
With effect of grade on right		305	N/A	N/A
Intersection				
To Right	B1	825	1095	1215
To Left	B2/B3	765	1035	1155
On Major Road	F	710	920	980



Smoke Tree Resort

Location: West Access

Sight Distance Analysis

Assumptions and/or Givens

<i>Elements of Design from AASHTO</i>	<i>6th Edition</i>	<i>AASHTO Ref</i>
Driver Eye Height		
Passenger Vehicle	3.50 ft	§3.2.6, p 3-14
Truck	7.60 ft	§3.2.6, p 3-14
Object Height		
Stopping Sight Distance	2.00 ft	§3.2.6, p 3-14
Passing Sight Distance	3.50 ft	§3.2.6, p 3-14
Vehicle Height	4.25 ft	§3.2.6, p 3-14
Driver Eye Location		
From Edge of Major Rd Traveled Way	14.50 ft	9.5.3, B1
Deceleration Rate (a)		
Passenger Vehicle	11.20 ft/sec ²	§3.2.2, p 3-3
Truck	N/A ft	
Brake reaction time (t)	2.50 sec	§3.2.2, p 3-4

Site Specific Data (Bike & turn lanes are outside traveled way and are not considered)

Major Street Design Speed (V _{major})	40	MPH
Grades - Approaching Minor Street from: (= = approaching downhill)		
Left (G _L)		%
Right (G _R)		%
Approach Grade Adjustment Factor	Left 1.0	Tbl 9-4, p 9-35
	Right 1.0	
Major Road Through Lanes on Each Approach	2.0	(Use 1 for RI/RO/[LI] only)
Median Width (in "Lane Equivalents")	0.0	(Use 0 for RI/RO/[LI] only)
Minor Road Approach Upgrade, if >3%		%
Minor Road Access (check restricted)	X	
	X	
	LI	LO/Th RO

Stopping Sight Distance = Brake Reaction Distance + Braking Distance

<u>Neglecting Effect of Grade</u>	$d = 1.47Vt + 1.075 \frac{V^2}{a}$	Eq 3-2, p 3-4
Calculated d=	300.6 ft	
Design d=	305 ft	

<u>With Effect of Grade</u>	$d = 1.47Vt + \frac{V^2}{30((\frac{a}{32.2}) \pm G)}$	Eq 3-3, p 3-5
Calculated d=	300.3 ft - left 305 ft - right	
Design d=	300.3 ft - left 305 ft - right	

SSD's do not consider design for truck operations, since better visibility is considered to offset longer braking distance. §3.2.2, p 3-6



Smoke Tree Resort

Location: West Access

Sight Distance Analysis

Intersection Sight Distances

Case B—Intersections with Stop Control on the Minor Road §9.5.3, p 9-36

Case B1—Left Turn from the Minor Road §9.5.3, p 9-36

Design Vehicle	Time Gap (t _g)	
Passenger Car	7.5 sec	Tbl 9-5, p 9-37
Single-Unit Truck	9.5 sec	Tbl 9-5, p 9-37
Combination Truck	11.5 sec	Tbl 9-5, p 9-37

Time gap adjustments		
Add'l lanes to cross (1 st is assumed)		
Passenger Car	0.5 sec	See Notes
Trucks	0.7 sec	below
Minor Approach Upgrade (Per each 1%>3%)	0.2 sec	Tbl 9-5, p 9-37

Site data		
Major Road Lanes on Left Approach	2.0	§9.5.3, p 9-37
Minor Road Approach Upgrade, if >3%	0 %	§9.5.3, p 9-37

Time Gap based on site data		
Design Vehicle Gap+Adj for Approach Grade>3%+Adjs for Add'l Lanes & Median		
Passenger Car	8.0 sec	
Single-Unit Truck	10.2 sec	
Combination Truck	12.2 sec	

ISD to left & right along Major Road ISD=1.47V_{major}t_g (ft) Eq 9-1, p 9-37

		ISD to Left and Right
Passenger Car	calculated ISD=	470.4 ft
	design ISD=	475 ft
Single-Unit Truck	calculated ISD=	599.8 ft
	design ISD=	600 ft
Combination Truck	calculated ISD=	717.4 ft
	design ISD=	720 ft



Smoke Tree Resort
Location: West Access

Sight Distance Analysis

Intersection Sight Distances (cont'd)

		<i>AASHTO Ref</i>
<u>Case B2—Right Turn from the Minor Road</u>		§9.5.3, p 9-40
&		
<u>Case B3—Crossing Maneuver from the Minor Road</u>		§9.5.3, p 9-43
Design Vehicle	Time Gap (t_g)	
Passenger Car	6.5 sec	Tbl 9-7, p 9-40
Single-Unit Tuck	8.5 sec	Tbl 9-7, p 9-40
Combination Truck	10.5 sec	Tbl 9-7, p 9-40
Time gap adjustments - Case B-3 Only*		
Add'l lanes to cross (1 st is assumed)		
Passenger Car	0.5 sec	See Notes
Trucks	0.7 sec	below
Minor Approach Upgrade (Per each 1%>3%)	0.1 sec	Tbl 9-7, p 9-40
Site data		
Major Road Lanes on Left Approach	2.0	§9.5.3, p 9-40
Minor Road Approach Upgrade, if >3%	0 %	§9.5.3, p 9-40

Time Gap based on site data (sec)	<u>B2 & B3</u>	<u>B3 Only</u>
<i>Design Vehicle Gap+Adj for Approach Grade>3% (+Adjs for Add'l Lanes & Median for B3)</i>		
Passenger Car	7.0	7.5
Single-Unit Tuck	9.2	9.9
Combination Truck	11.2	11.9

ISD to left (B2/B3) & right (B3) along Major Rd $ISD=1.47V_{major}t_g$ (ft) Eq 9-1, p 9-37

			ISD to Left	ISD to right
			(B2 & B3)	(B3 Only)
Passenger Car	calculated ISD=	411.6	441.0	
	design ISD=	415	445	
Single-Unit Tuck	calculated ISD=	541.0	582.1	
	design ISD=	545	585	
Combination Truck	calculated ISD=	658.6	699.7	
	design ISD=	660	700	

*Number of major road lanes is irrelevant in Case B2.

The differences between Case B1 and Cases B2 & B3 are reduced time gaps and time gap adjustment for the minor approach upgrade. §9.5.3, p 9-43



Smoke Tree Resort
Location: West Access

Sight Distance Analysis

Intersection Sight Distances (cont'd)

		<i>AASHTO Ref</i>
<u>Case F—Left Turns from the Major Road</u>		§9.5.3, p 9-51
Design Vehicle	Time Gap (t_g)	
Passenger Car	5.5 sec	bl 9-13, p 9-51
Single-Unit Tuck	6.5 sec	bl 9-13, p 9-51
Combination Truck	7.5 sec	bl 9-13, p 9-51
Time gap adjustments		
Add'l lanes to cross (1 assumed)		
Passenger Car	0.5 sec	See Notes to
Trucks	0.7 sec	bl 9-13, p 9-51
Site data		
Opposing Lanes (adj'd for x-wide median)	1.0	
Time Gap based on site data		
<i>Design Vehicle Gap+Adj for Add'l Opposing Lanes</i>		
Passenger Car	6.0 sec	
Single-Unit Tuck	7.2 sec	
Combination Truck	8.2 sec	
ISD to front along Major Road	$ISD=1.47V_{major}t_g$ (ft)	Eq 9-1, p 9-37
Passenger Car	calculated ISD= 352.8 ft	
	design ISD= 355 ft	
Single-Unit Tuck	calculated ISD= 423.4 ft	
	design ISD= 425 ft	
Combination Truck	calculated ISD= 482.2 ft	
	design ISD= 485 ft	

The differences between Case F and Cases B1, B2 & B3 are reduced time gaps and no time gap adjustment for any minor approach upgrade. §9.5.3, p 9-43

SIGHT DISTANCE SUMMARY

Sight Distance Type	Governing Case	Car	SU Truck	Combo Truck
Stopping				
Without effect of grade		305	N/A	N/A
With effect of grade on left		305	N/A	N/A
With effect of grade on right		305	N/A	N/A
Intersection				
To Right	B3	Restricted	Restricted	Restricted
To Left	B2/B3	415	545	660
On Major Road	F	Restricted	Restricted	Restricted



Smoke Tree Resort

Location: Quail Run Road

Sight Distance Analysis

Assumptions and/or Givens

<i>Elements of Design from AASHTO</i>	<i>6th Edition</i>	<i>AASHTO Ref</i>
Driver Eye Height		
Passenger Vehicle	3.50 ft	§3.2.6, p 3-14
Truck	7.60 ft	§3.2.6, p 3-14
Object Height		
Stopping Sight Distance	2.00 ft	§3.2.6, p 3-14
Passing Sight Distance	3.50 ft	§3.2.6, p 3-14
Vehicle Height	4.25 ft	§3.2.6, p 3-14
Driver Eye Location		
From Edge of Major Rd Traveled Way	14.50 ft	9.5.3, B1
Deceleration Rate (a)		
Passenger Vehicle	11.20 ft/sec ²	§3.2.2, p 3-3
Truck	N/A ft	
Brake reaction time (t)	2.50 sec	§3.2.2, p 3-4

Site Specific Data (Bike & turn lanes are outside traveled way and are not considered)

Major Street Design Speed (V _{major})	30 MPH	
Grades - Approaching Minor Street from: (– = approaching downhill)		
Left (G _L)	%	
Right (G _R)	%	
Approach Grade Adjustment Factor	Left 1.0	Tbl 9-4, p 9-35
	Right 1.0	
Major Road Through Lanes on Each Approach	1.0 (Use 1 for RI/RO/[LI] only)	
Median Width (in "Lane Equivalents")	0.0 (Use 0 for RI/RO/[LI] only)	
Minor Road Approach Upgrade, if >3%	%	
Minor Road Access (check restricted)		
	LI	LO/Th RO

Stopping Sight Distance = Brake Reaction Distance + Braking Distance

<u>Neglecting Effect of Grade</u>	$d = 1.47Vt + 1.075 \frac{V^2}{a}$	Eq 3-2, p 3-4
Calculated d=	196.7 ft	
Design d=	200 ft	

<u>With Effect of Grade</u>	$d = 1.47Vt + \frac{V^2}{30((\frac{a}{32.2}) \pm G)}$	Eq 3-3, p 3-5
Calculated d=	196.3 ft - left 200 ft - right	
Design d=	196.3 ft - left 200 ft - right	

SSD's do not consider design for truck operations, since better visibility is considered to offset longer braking distance. §3.2.2, p 3-6



Smoke Tree Resort

Location: Quail Run Road

Sight Distance Analysis

Intersection Sight Distances

Case B—Intersections with Stop Control on the Minor Road

AASHTO Ref
§9.5.3, p 9-36

Case B1—Left Turn from the Minor Road

§9.5.3, p 9-36

Design Vehicle	Time Gap (t _g)	
Passenger Car	7.5 sec	Tbl 9-5, p 9-37
Single-Unit Truck	9.5 sec	Tbl 9-5, p 9-37
Combination Truck	11.5 sec	Tbl 9-5, p 9-37

Time gap adjustments

Add'l lanes to cross (1 st is assumed)		
Passenger Car	0.5 sec	See Notes
Trucks	0.7 sec	below
Minor Approach Upgrade (Per each 1%>3%)	0.2 sec	Tbl 9-5, p 9-37

Site data

Major Road Lanes on Left Approach	1.0	§9.5.3, p 9-37
Minor Road Approach Upgrade, if >3%	0 %	§9.5.3, p 9-37

Time Gap based on site data

Design Vehicle Gap+Adj for Approach Grade>3%+Adjs for Add'l Lanes & Median

Passenger Car	7.5 sec
Single-Unit Truck	9.5 sec
Combination Truck	11.5 sec

ISD to left & right along Major Road ISD=1.47V_{major}t_g (ft) Eq 9-1, p 9-37

		ISD to Left and Right
Passenger Car	calculated ISD=	330.8 ft
	design ISD=	335 ft
Single-Unit Truck	calculated ISD=	419.0 ft
	design ISD=	420 ft
Combination Truck	calculated ISD=	507.2 ft
	design ISD=	510 ft



Smoke Tree Resort
Location: Quail Run Road

Sight Distance Analysis

Intersection Sight Distances (cont'd)

			<i>AASHTO Ref</i>
<u>Case B2—Right Turn from the Minor Road</u>			§9.5.3, p 9-40
&			
<u>Case B3—Crossing Maneuver from the Minor Road</u>			§9.5.3, p 9-43
Design Vehicle	Time Gap (t _g)		
Passenger Car	6.5 sec	Tbl 9-7, p 9-40	
Single-Unit Tuck	8.5 sec	Tbl 9-7, p 9-40	
Combination Truck	10.5 sec	Tbl 9-7, p 9-40	
Time gap adjustments - Case B-3 Only*			
Add'l lanes to cross (1 st is assumed)			
Passenger Car	0.5 sec	See Notes	
Trucks	0.7 sec	below	
Minor Approach Upgrade (Per each 1%>3%)	0.1 sec	Tbl 9-7, p 9-40	
Site data			
Major Road Lanes on Left Approach	1.0	§9.5.3, p 9-40	
Minor Road Approach Upgrade, if >3%	0 %	§9.5.3, p 9-40	

Time Gap based on site data (sec)	<u>B2 & B3</u>	<u>B3 Only</u>
<i>Design Vehicle Gap+Adj for Approach Grade>3%(+Adjs for Add'l Lanes & Median for B3)</i>		
Passenger Car	6.5	6.5
Single-Unit Tuck	8.5	8.5
Combination Truck	10.5	10.5

ISD to left (B2/B3) & right (B3) along Major Rd ISD=1.47V_{major}t_g (ft) Eq 9-1, p 9-37

			ISD to Left	ISD to right
			(B2 & B3)	(B3 Only)
Passenger Car	calculated ISD=	286.7	286.7	
	design ISD=	290	290	
Single-Unit Tuck	calculated ISD=	374.9	374.9	
	design ISD=	375	375	
Combination Truck	calculated ISD=	463.1	463.1	
	design ISD=	465	465	

*Number of major road lanes is irrelevant in Case B2.

The differences between Case B1 and Cases B2 & B3 are reduced time gaps and time gap adjustment for the minor approach upgrade. §9.5.3, p 9-43



Smoke Tree Resort
Location: Quail Run Road

Sight Distance Analysis

Intersection Sight Distances (cont'd)

			<i>AASHTO Ref</i>
<u>Case F—Left Turns from the Major Road</u>			§9.5.3, p 9-51
Design Vehicle	Time Gap (t _g)		
Passenger Car	5.5 sec	bl 9-13, p 9-51	
Single-Unit Tuck	6.5 sec	bl 9-13, p 9-51	
Combination Truck	7.5 sec	bl 9-13, p 9-51	
Time gap adjustments			
Add'l lanes to cross (1 assumed)			
Passenger Car	0.5 sec	See Notes to	
Trucks	0.7 sec	bl 9-13, p 9-51	
Site data			
Opposing Lanes (adj'd for x-wide median)	0.0		
Time Gap based on site data			
<i>Design Vehicle Gap+Adj for Add'l Opposing Lanes</i>			
Passenger Car	5.5 sec		
Single-Unit Tuck	6.5 sec		
Combination Truck	7.5 sec		
ISD to front along Major Road	ISD=1.47V _{major} t _g (ft)		Eq 9-1, p 9-37
Passenger Car	calculated ISD=	242.6 ft	
	design ISD=	245 ft	
Single-Unit Tuck	calculated ISD=	286.7 ft	
	design ISD=	290 ft	
Combination Truck	calculated ISD=	330.8 ft	
	design ISD=	335 ft	

The differences between Case F and Cases B1, B2 & B3 are reduced time gaps and no time gap adjustment for any minor approach upgrade. §9.5.3, p 9-43

SIGHT DISTANCE SUMMARY

Sight Distance Type	Governing Case	Car	SU Truck	Combo Truck
Stopping				
Without effect of grade		200	N/A	N/A
With effect of grade on left		200	N/A	N/A
With effect of grade on right		200	N/A	N/A
Intersection				
To Right	B1	335	420	510
To Left	B2/B3	290	375	465
On Major Road	F	245	290	335

