



10 APPENDICES

- A. ACOUSTICAL REPORTS
- B. CIVIL ENGINEERING REPORTS
- C. EXISTING LIGHTING PHOTOMETRIC STUDY**
- D. PARKING ANALYSIS & MEMORANDUM
- E. TRAFFIC IMPACT ANALYSIS

SCOTTSDALE PLAZA RESORT EXISTING LIGHTING PHOTOMETRIC STUDY



Prepared for:

Highgate Hotel, L.P.
870 Seventh Avenue, Second Floor
New York, NY 10018

Site Address:

7200 North Scottsdale Road
Scottsdale, AZ 85253

Prepared by:

Creative Designs in Lighting
15982 North 78th Street, Suite A
Scottsdale, AZ 85260

SCOPE

Creative Designs in Lighting was contracted to measure existing light levels, develop an inventory of exterior light fixtures, and prepare a photometric study to determine a baseline for the planned renovation of the property.

DOCUMENTS

An ALTA survey was provided in CAD format from Aaron Woodward of Rider Levett Bucknall. No additional as-built documents were provided by the client. CDL did locate some original as-built information on-line that included architectural drawings from 1983, however no electrical drawings or lighting drawings were included in the sets. These documents are available on the website for the Town of Paradise Valley and were forwarded to Mr. Woodward for use in the proposed renovations.

SITE VERIFICATION

CDL made several site visits during daylight hours and after sunset to inventory existing exterior lighting fixtures. The ALTA survey was instrumental in locating many fixtures shown, but there were a substantial number of fixtures that were located that did not show on the survey (and a small number of fixtures that were shown on the study that are no longer there).

REPRESENTATIVE PHOTOMETRIC LIGHT LEVEL MEASUREMENTS

The light meter used for this study is the Extech 401025 and measurements were taken in footcandles.



Perimeter Light Trespass - Light trespass levels were read at the property lines at 5'-0" above grade with light meter aimed into the property. In summary, all perimeter points measured read 0.1fc or less since generally all lights were located at least 13' from the property line (exceptions

to this were internally illuminated signage and three fixtures at the Scottsdale Road frontage near the porte cochere).

Ground Plane Light Levels - Other light levels measured throughout the property were taken at the ground level with the sensor aimed up. The majority of areas beyond parking areas and pedestrian pathways measured 0.1fc or less. The highest light levels were found on the tennis courts peaking around 28.0fc.

PHOTOMETRIC MODEL

The software utilized for the photometric model is Visual Lighting 2020 r2. The program utilizes *.ies files to model the lighting output of each fixture type. The ies.* files used in the program were selected to most closely model the existing light fixture output (note- *.ies files for the actual fixture types were not available from the manufacturers that were identified or the manufacture and model numbers were not available). Light fixtures included in the photometric model were those that added light to ground plane, so the following were excluded from the model:

- Flood lights and landscape lights that were aimed upwards.
- Downlights and sconces located under canopies or overhangs (considered to be within the building perimeter).
- Lighting within pools and water features.
- Signage that is internally illuminated or flood lighted externally.

Photometric meshes were calculated on 10' X 10' grids and masked out within building perimeters.

AERIAL PHOTOS WITH COMMENTARY

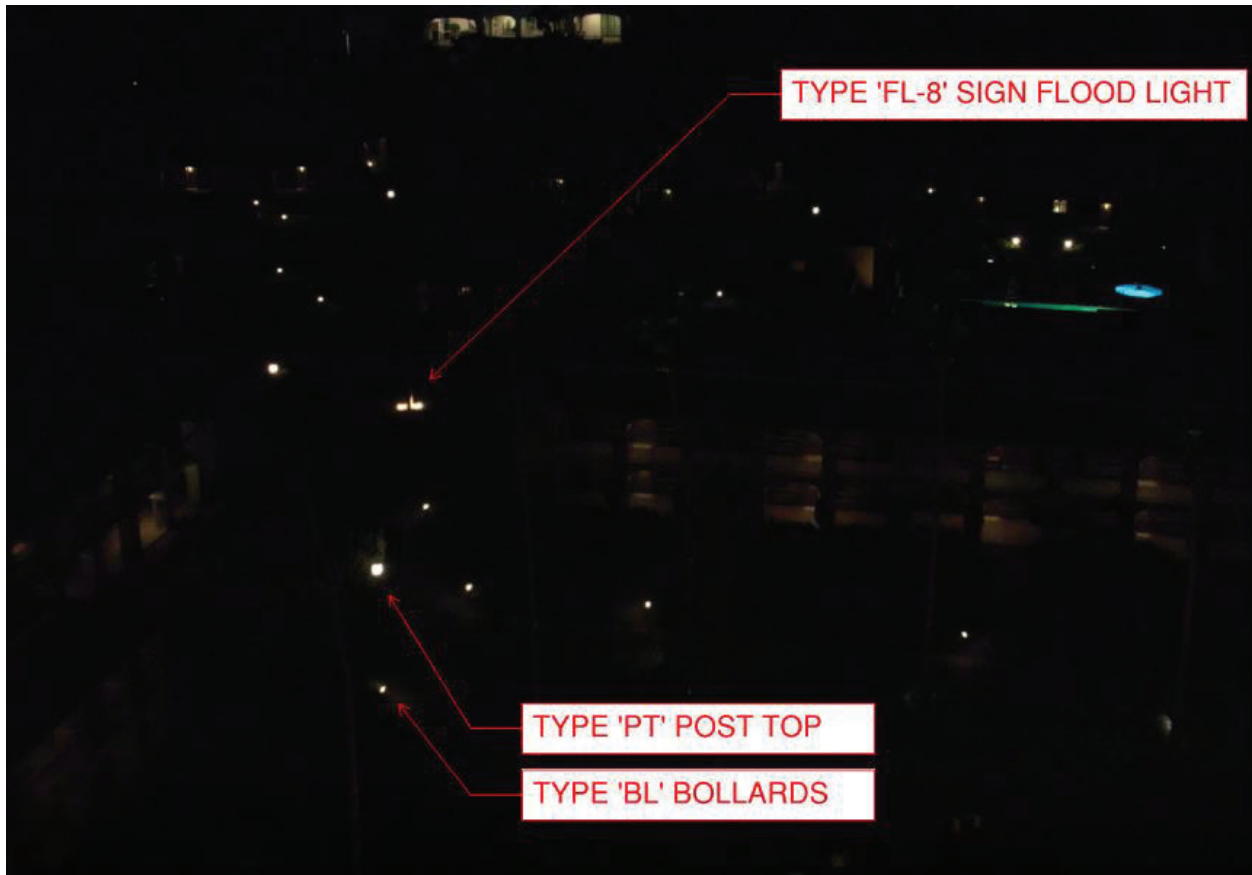

The overall lighting brightness of the post top fixtures lenses was significantly brighter than the surfaces they were intended to illuminate (ground levels and building faces). This caused glare amidst the generally low light surroundings. This aerial photo shows the effect of seeing the fixture brightness, but very little illuminated from it.

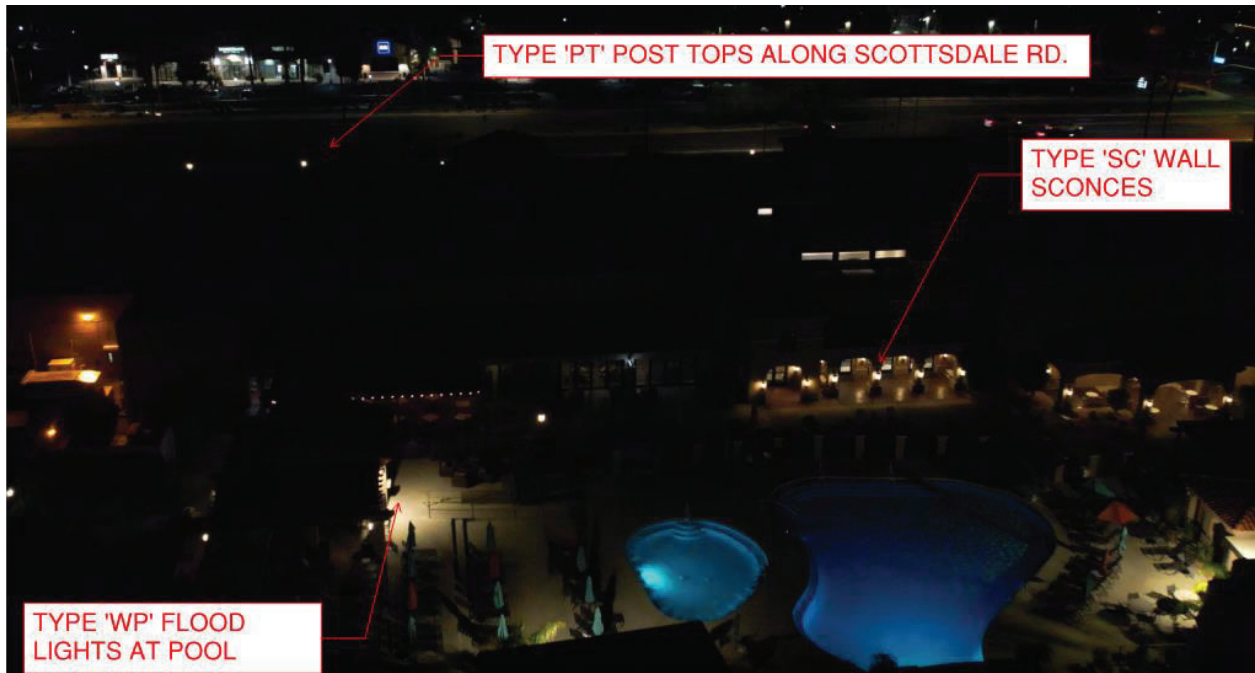

The pool deck is illuminated by wall packs and flood lights and is not uniformly illuminated. Building mounted sconces provide additional lighting at building entrances.







Post top “acorn” lights and festoon lights illuminate the event lawn with soft uniform lighting. Besides the tennis courts, this is the brightest area on site. Note that there are additional floodlights mounted on palm trees for additional event lighting that were not energized in this photo.



FIXTURE SCHEDULE

The following matrix is an inventory of the type of light fixtures discovered on site.

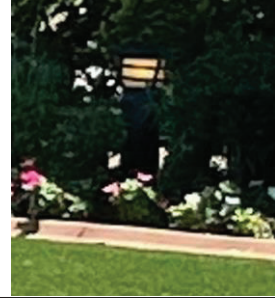

IMAGE	TYPE	DESCRIPTION	QUANTITY
	TYPE 'PT' 2 nd AVENUE PLAZA SERIES	POST TOP FIXTURE (1) A-LAMP, E26 BASE 5' MTD ON 3" ROUND POLE DARK BRONZE TRANSLUCENT LENS	107
	TYPE 'PT-2' 2 nd AVENUE PLAZA SERIES	POST TOP FIXTURE (2) A-LAMP, E26 BASE 5' MTD ON 3" ROUND POLE DARK BRONZE TRANSLUCENT LENS	7
	TYPE 'PT-1' 2 nd AVENUE PLAZA SERIES	SAME AS PT-2 EXCEPT SINGLE SIDE MOUNTED FIXTURE	1
	TYPE 'TC'	TENNIS COURT SPORTS LIGHTER FIXTURE METAL HALIDE LAMP GREEN FINISH SINGLE HEAD	7
	TYPE 'TC-2'	TENNIS COURT SPORTS LIGHTER FIXTURE METAL HALIDE LAMP GREEN FINISH TWO HEAD	4

	<p>TYPE 'PA'</p> <p>SIMILAR TO AAL FEDERAL GLOBE</p>	<p>POST TOP ACORN FIXTURE AT EVENT LAWN</p>	<p>4</p>
	<p>TYPE 'CT-1'</p>	<p>COLUMN MTD 3-BULB, E26 (T.B.V.) CLEAR LENS</p>	<p>3</p>
	<p>TYPE 'CT-G'</p>	<p>COLUMN MTD. LANTERN ON GABION WALL</p>	<p>4</p>







	<p>TYPE 'PL'</p> <p>KICHLER ECLIPSE SERIES</p>	<p>PATH LIGHT AT LANDSCAPE OPEN-AIR ARCADE</p>	<p>6</p>
	<p>TYPE 'BL'</p> <p>KICHLER UFO SERIES (DISCONTINUED)</p>	<p>BOLLARD LOW VOLTAGE PATHWAY BOLLARD WITH FROSTED GLASS IN 360 DEGREE DISTRIBUTION. NOT DARK SKY RATED.</p>	<p>241</p>

	<p>TYPE 'BL-S'</p> <p>KICHLER UFO SERIES-SMALL (DISCONTINUED)</p>	<p>BOLLARD LOW VOLTAGE PATHWAY BOLLARD WITH FROSTED GLASS IN 360 DEGREE DISTRIBUTION. NOT DARK SKY RATED.</p>	<p>22</p>
	<p>TYPE 'BL-G'</p>	<p>SAME AS TYPE 'BL' WITH ADDED GABION WALL ENCLOSURE</p>	<p>7</p>



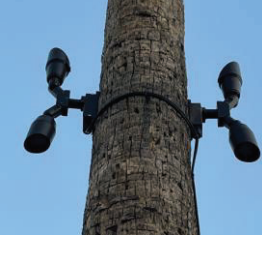

FLOOD LIGHTS

IMAGE	TYPE	DESCRIPTION	QUANTITY
	<p>TYPE 'FL-1'</p>	<p>GROUND MTD. FLOOD LIGHT PAR 30 LAMP, E26 BASE DARK BRONZE NO LENS</p>	<p>41</p>
	<p>TYPE 'FL-2'</p>	<p>GROUND MTD. FLOOD LIGHT LITHONIA INTEGRAL LED DARK BRONZE FROSTED LENS</p>	<p>11</p>
	<p>TYPE 'FL-3'</p>	<p>GROUND MTD. FLOOD LIGHT HIGH PRESSURE SODIUM LAMP (T.B.V.) DARK BRONZE CLEAR LENS</p>	<p>2</p>

	<p>TYPE 'FL-4'</p>	<p>STANCION MTD. FLOOD LIGHT INTEGRAL LED GRAY CLEAR LENS</p>	<p>3</p>
	<p>TYPE 'FL-5'</p>	<p>STANCION MTD. FLOOD LIGHT INTEGRAL LED DARK BRONZE CLEAR LENS</p>	<p>3</p>
	<p>TYPE 'FL-6'</p>	<p>STANCION MTD. LANDSCAPE ACCENT MR16 DARK BRONZE (OR SAND AT ENTRY) CLEAR LENS</p>	<p>9</p>
	<p>TYPE 'FL-7'</p>	<p>STANCION MTD. LANDSCAPE ACCENT INTEGRAL LED DARK BRONZE CLEAR LENS</p>	<p>2</p>
	<p>TYPE 'FL-8'</p>	<p>J-BOX MTD. WEATHER PROOF "PORCELAIN" SOCKET PAR 38 LED, E26 BASE</p> <p>SHROUDED IN MOST LOCATIONS</p>	<p>41</p>
	<p>TYPE 'FL-8-2'</p>	<p>J-BOX MTD. WEATHER PROOF "PORCELAIN" SOCKET 2-HEADED PAR 38 LED, E26 BASE</p> <p>SHROUDED IN MOST LOCATIONS</p>	<p>18</p>

	TYPE 'FL-9'	STANCION MTD. LANDSCAPE LIGHT SAND COLOR	2
	TYPE 'FL-F'	FLAG POLE UPLIGHT FLOODS	3
	TYPE 'FL-H'	WIDE LANDSCAPE FLOOD LIGHT GROUND MTD.	1
	TYPE 'FL-T'	SMALL LANDSCAPE FLOOD LIGHT GROUND MTD.	20
	TYPE 'TB'	TREE MOUNTED BULLET ACCENT LANDSCAPE LIGHTS	16
	TYPE 'FL-FOUNTAIN'	SUBMERSIBLE NICHE LIGHT INTEGRAL LED	NOT QUANTIFIED

WALL PACKS

IMAGE	TYPE	DESCRIPTION	QUANTITY
	TYPE 'SC' 2ND AVENUE PLAZA SERIES	DECORATIVE WALL SCONCES (VARIOUS SIZES)	69 (NOTE- ADDITIONAL SCONCES LOCATED IN COVERED PATIOS)
	TYPE 'SGN'	WALL PACK COMPACT FLUORESCENT (T.B.V.)	24
	TYPE 'WP'	WALL PACK VARIOUS SIZES HPS (T.B.V.)	10
	TYPE 'FT'	FESTOON LIGHTING	7 locations

	TYPE 'TD'	TREE MTD. DOWNLIGHTS	2

SELECT FIXTURE CUTSHEETS

The following fixture cutsheets were found to match existing light fixtures. Not all fixture cutsheets were able to be tracked down without as-built information or model number information available.

SPECIFICATIONS

Certifications/Qualifications	
	www.kichler.com/warranty
Dimensions	
Height	28.75"
Width	8.00"
Electrical	
Operating Voltage Range	9-15 VAC
Voltage	12V
Light Source	
Delivered Lumens	224
Lamp Included	Included
Lamp Type	LED
Light Source	LED
Max or Nominal Watt	3.57W
Mounting/Installation	
Location Rating	Wet
Photometrics	
Color Rendering Index	73
Delivered Efficacy (Lumens/Watt)	64
Kelvin Temperature	2800K

FIXTURE ATTRIBUTES

Housing	
Primary Material	ALUMINUM
Product/Ordering Information	
SKU	16133AZT28
Finish	Textured Architectural Bronze
UPC	783927481335
Finish Options	

-  Textured Architectural Bronze
-  Textured Black

TYPE 'BL'



- Reliable, efficient operation
- Type 2, 3, 4, 5 distributions
- 3000K, 4000K and 5000K CCT
- 0-10V dimming ready
- Integral surge protection
- Scaled family members



1. LUMINAIRE	2. DECORATIVE STYLE	3. GLOBE STYLE	4. OPTICAL SYSTEM	5. COLOR TEMP	6. DRIVER	7. COLOR	8. OPTIONS	9. MOUNTING
--------------	---------------------	----------------	-------------------	---------------	-----------	----------	------------	-------------

1. LUMINAIRE

FGS (Small scale housing – LED)
Slips over a 4”/100mm O.D. pole

2. DECORATIVE STYLE

RB (Rib Fitter Design)
LF (Leaf Fitter Design)

3. GLOBE STYLE

STANDARD ACORN GLOBE
SAL (One-piece globe)

4. OPTICAL SYSTEM

Y2-36LED (Type 2)
Y3-36LED (Type 3)
Y4-36LED (Type 4)
Y5-36LED (Type 5)

5. COLOR TEMPERATURE

3K (Warm White, 3000K output)
4K (Neutral White, 4000K output)
5K (Bright White, 5000K output)

6. DRIVER (120 thru 277 volt)

450 (450mA drive current, 53 watts)

7. COLOR

BLS	Black Gloss Smooth
BLT	Black Matte Textured
DBS	Dark Bronze Gloss Smooth
DBT	Dark Bronze Matte Textured
GTT	Graphite Matte Textured
LGS	Light Grey Gloss Smooth
LGT	Light Grey Matte Textured
PSS	Platinum Silver Gloss Smooth
VGT	Verde Green Matte Textured
WHS	White Gloss Smooth
WHT	White Matte Textured
CC¹	Custom Color

¹ Consult factory for custom color, marine and corrosive finish

8. OPTIONS

FS1 (Single fuse holder, fuse by others)
FS2 (Double fuse holder, fuse by others)
TA3 (Tenon adaptor slips over a 3”/75 mm O.D. by 4”/100 mm tenon)
AD5 (Adaptor to slip over a 5”/125mm O.D. pole and is 4”/100mm long. Secures to the pole with four stainless steel set screws)
TA23 (Tenon adaptor, slips over a 2 3/8” O.D. by 4”/100mm tenon)
ALF (Cast filigree basket.)
PHC (Integral button type photo control sensor. Specify line voltage 120/277V)
347 (347VAC input)
480 (480VAC input)

SCP (Sensor Control Programmable) pole accessory is available to provide occupancy detection for outdoor applications meeting California Title 24. For complete spec sheet and ordering information, visit www.aal.net/products/sensor_control_programmable/

9. MOUNTING (OPTIONAL)

POLE MOUNT

Bolts to the side of a 4”/100mm DIA. or 5”/125mm DIA. pole

TRA1M	TRA1L	TRA5U
TRA55	TRA56 (4" only)	
TRA57	TRA6U	

WALL MOUNT

WMA1M	WMA1L	WMA3
WMA35U	WMA36U	
WMA55	WMA56	WMA57

PIER MOUNT

PM1	PM2PM3
-----	--------

[Visit www.aal.net](http://www.aal.net) for Arms, Poles & Accessories Specification Guide

SPECIFICATIONS

HOUSING

- Luminaire housings is cast aluminum, A356 alloy.
- Outer lens are acrylic and sealed to the housing with a silicone gasket on the top and bottom.
- All internal and external hardware are stainless steel.
- Finial and optional cast filigree basket are painted to match housing.

OPTICAL MODULE

- Light emitting diode (LED) assembly are sealed to a die-cast anodized aluminum heat sink with an injection molded silicone rubber gasket and stainless steel bezel, IP66.
- LED optics are injection molded PMMA acrylic and be mounted to a metal printed circuit board with a uniform conformal coating over the panel surface and electrical features.

ELECTRICAL

- Luminaires shall accept 120 thru 277 50/60Hz input voltage have integral surge protection and wire leads for controls.
- Drivers are U.L recognized, have a minimum starting temperature of -30°C and have a 0-10v dimming interface with a dimming range of 10-100%.

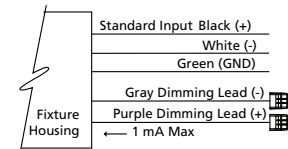

- Drivers shall have a power factor $\geq .90$ and THD of $\leq 20\%$ at full load with an inrush current maximum of < 20.0 Amps maximum at 230VAC.
- Drivers shall not be compatible with current sourcing dimmers, consult factory for current list of known compatible dimming systems
- Thermal shield will be provided with all configurations for added protection in the event of abnormally excessively high ambient temperature conditions.
- Surge protector are U.L. recognized and have a surge current rating of 10,000 Amps using the industry standard 8/20uSec wave and surge rating of 372J.



ARCHITECTURAL AREA LIGHTING
16555 East Gale Ave. | City of Industry | CA 91745
P 626.968.5666 | F 626.369.2695 | www.aal.net
Copyright © 2014 | Rev 2.15

JOB	_____
TYPE	_____
NOTES	_____

SPECIFICATIONS (CONT.)

CONTROLS

- SCP are have an integral surge protection device with a current rating of 10,000 Amps using the industry standard 8/20uSec wave and sure rating of 372J
- Sensor not intended for use with additional photo-control, wireless control or dimming systems.

SERVICING

- The electrical assembly are mounted to a prewired internal service tray and accessed by releasing the service latch to allow the fixture to hinge open into a service position.

FINISH

- Luminaire finish are consist of a five stage pretreatment regimen with a polymer primer sealer, oven dry off, and top coated with a thermoset super TGIC polyester powder coat finish.
- Luminaire finish meets the AAMA 605.2 performance specification which includes passing a 3000 hour salt spray test for corrosion resistance.

CERTIFICATION

- Luminaire are listed with ETL for outdoor, wet location use, UL1598, UL 8750 and Canadian CSA Std. C22.2 no.250. IP66.

WARRANTY / TERMS AND CONDITIONS OF SALE

Download:

<http://www.hubbellighting.com/resources/warranty/>

AAL reserves the right to change product specifications without notice.

DIMENSIONS

FGS

HEIGHT:	36"	914mm
LENGTH:	14"	356mm
WIDTH:	14"	356mm
WEIGHT:	22 lbs	
EPA:	1.19	

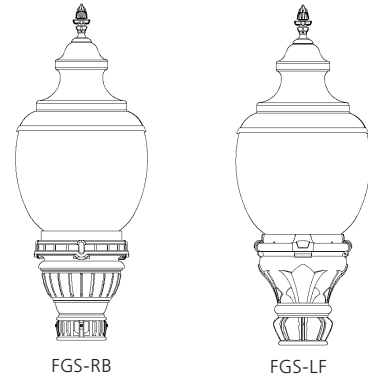

PERFORMANCE DATA (36 LEDS, 450 MA DRIVE CURRENT, 53 WATTS)

TYPE	LENS	5K					4K					3K					DRIVE CURRENT (mA)	SYSTEM WATTS
		LUMENS	LPW	B	U	G	LUMENS	LPW	B	U	G	LUMENS	LPW	B	U	G		
T2	SAL	5183	71	2	4	3	5125	70	2	4	3	4997	68	2	4	3	45	53
T3		4667	64	1	4	2	4615	63	1	4	2	4499	62	1	4	2		
T4		5083	70	1	4	2	5026	69	1	4	2	4900	67	1	4	3		
T5		4645	64	3	4	2	4593	63	3	4	2	4478	61	2	4	2		
CCT Average		5100K					4200K					3000K						
CCT Range		4600K – 5600					3800K – 4600K					2800K – 3175K						
CRI Minimum		≤70					≤70					≤80						

FGS-RB-SLG-Y5-36LED-5K-450

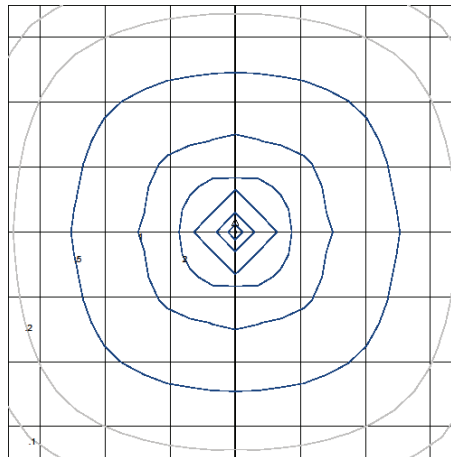

10' MOUNTING HEIGHT

FGS-RB-SLG-Y3-36LED-5K-450

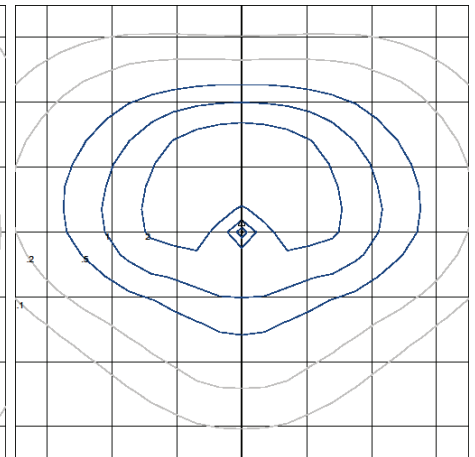

10' MOUNTING HEIGHT

[IES files can be found at www.aal.net](http://www.aal.net)

AMBIENT TEMP.	0	25,000	50,000	*TM-21-11 60,000	100,000	REPORTED L70 (HRS)
25°C/77°F	100%	97%	96%	95%	93%	>60,000
40°C/104°F	100%	95%	93%	92%	89%	>60,000



ARCHITECTURAL AREA LIGHTING
16555 East Gale Ave. | City of Industry | CA 91745
P 626.968.5666 | F 626.369.2695 | www.aal.net
Copyright © 2014 | Rev 2.15



JOB _____
TYPE _____
NOTES _____

SPECIFICATIONS

Certifications/Qualifications	
	www.kichler.com/warranty
Dimensions	
Height	18.50"
Width	4.50"
Electrical	
Operating Voltage Range	12 VAC
Voltage	12V
Light Source	
Lamp Included	Included
Lamp Type	S8 WEDGE
Max or Nominal Watt	24.40
# of Bulbs/LED Modules	1
Mounting/Installation	
Lead Wire Length	37"
Location Rating	CUL_12V

FIXTURE ATTRIBUTES

Housing	
Primary Material	ALUMINUM
Product/Ordering Information	
SKU	15323AZT
Finish	Textured Architectural Bronze
UPC	783927105019

Finish Options	
	Textured Architectural Bronze
	Textured Black

TYPE 'PL'



ALSO IN THIS FAMILY





10" WIDE PLAZA LANTERN WALL SCONCE | 128018

TYPE 'SC'
AND
SIMILAR
DESIGN
FOR TYPE
'PT' AND
'PT-2'



ADDITIONAL INFORMATION

Dimensions and Weight	Availability:: Custom Crafted In Yorkville, New York Please Allow 56 Days Item Maximum Height:: 25" Item Length or Depth:: 5.5" Depth Item Width or Depth:: 10" Width Item Weight:: 11 lbs.
Lamping	Base Type:: E26 Lens Color:: Travertine Idalight Quantity:: 1 Shape:: A19 Wattage:: 60
Other	Family:: Plaza Lantern Metal Finish:: Hanna Copper



10" WIDE PLAZA LANTERN WALL SCNCE | 158273

TYPE 'SC'



ADDITIONAL INFORMATION

	Availability:: Custom Crafted In Yorkville, New York Please Allow 56 Days
Dimensions and Weight	Item Maximum Height:: 36"
	Item Length or Depth:: 10" Depth
	Item Width or Depth:: 10" Width
	Item Weight:: 17 lbs.
Lamping	Base Type:: E26
	Lens Color:: Frosted Seeded Glass
	Quantity:: 1
	Shape:: A19
Other	Wattage:: 40
	Family:: Plaza Lantern
	Metal Finish:: Smoke



14" WIDE PLAZA LANTERN WALL SCONCE | 146468

TYPE 'SC'



ADDITIONAL INFORMATION

Dimensions and Weight

Availability:: [Custom Crafted In Yorkville, New York Please Allow 56 Days](#)

Item Minimum Height:: "

Item Maximum Height:: "

Item Length or Depth:: " [Depth](#)

Item Length or Square:: " [Length](#)

Item Width or Depth:: " [Width](#)

Item Weight:: [52 lbs.](#)

Lamping

Lens Color:: [Frosted Seeded Glass](#)

Other

Family:: [Plaza Lantern](#)

Metal Finish:: [Smoke](#)

TYPE 'TC'

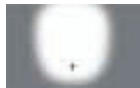

[A60]

IOS® Innovative Optical System:

[A60] Asymmetric 'forward throw' distribution

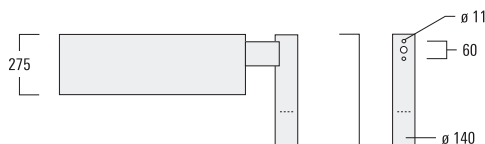
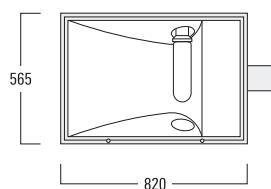

[A60]		lm	Gear	kg
SBL480	HRI-T 1000W/N/Sc/E40*	138-9302	100000	[HPF] 33.0

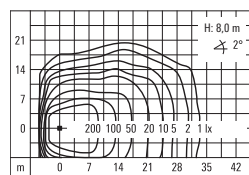

[A60]

TM-C 80 poles			kg
for 1 x SBL480	270-9200	TM-C 80 140.1	175.0
for 2 x SBL480 (180°)	270-9201	TM-C 80 140.2B	175.0
for 2 x SBL480 (90°)	270-9202	TM-C 80 140.2L	180.0

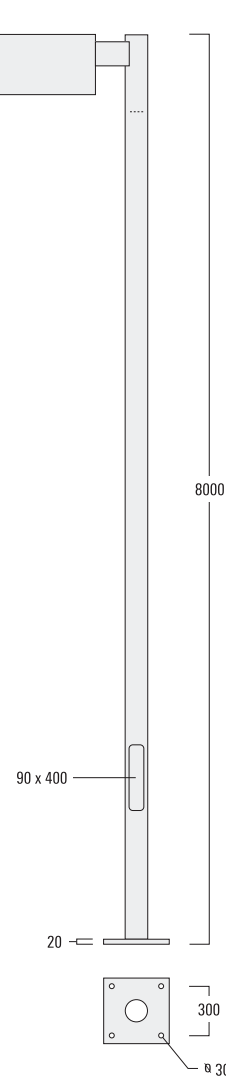

* Radium.

SINGLE COURT SYSTEMS – HIT

Recreational

- Four poles
- 8 m mounting height

An economic solution suitable for recreational and residential developments, such as condominiums and resorts etc. Excellent illuminance and uniformity values in both, the principal (PPA) and the total (TPA) playing areas.

Statistics*	PPA	TPA
Eave	333 lx	280 lx
E _{max}	419 lx	419 lx
E _{min}	216 lx	80 lx
U ₁	0.65	0.29
U ₂	0.52	0.19

Equipment list	Quantity
138-9302 SBL480 [A60] tennis court luminaire	4
270-9200 TM-C 80 140.1 pole	4
TE8706 HRI-T 1000W/N/Sc/E40** high output metal halide lamp	4

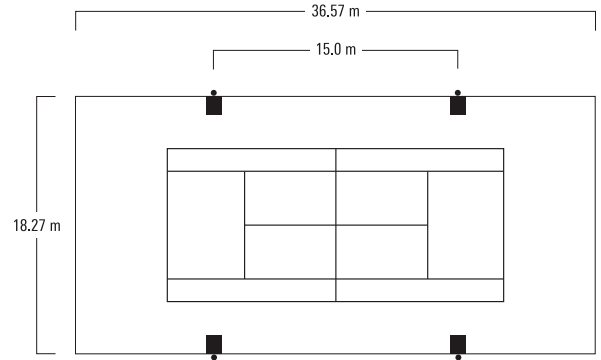

Club Competition

- Six poles
- 8 m mounting height

The perfect system for top class club competition and commercial tournaments. Outstanding performance in the playing volume and throughout the area of play.

Statistics*	PPA	TPA
Eave	417 lx	394 lx
E _{max}	467 lx	467 lx
E _{min}	335 lx	274 lx
U ₁	0.80	0.70
U ₂	0.72	0.59

Equipment list	Quantity
138-9302 SBL480 [A60] tennis court luminaire	6
270-9200 TM-C 80 140.1 pole	6
TE8706 HRI-T 1000W/N/Sc/E40** high output metal halide lamp	6

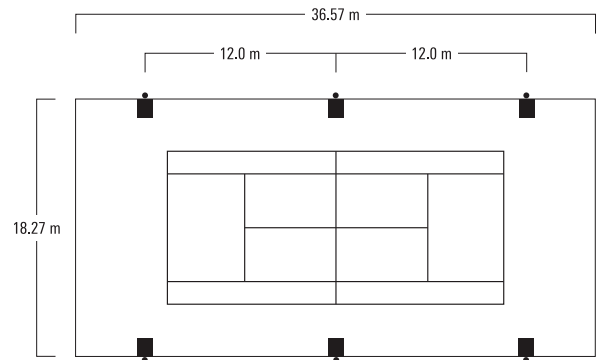

* The principal playing area (PPA) is defined as the lined area, measuring 10.97 m x 23.77 m. The total playing area (TPA) covers the larger area of action and typically measures 18.27 m x 36.57 m. For both the PPA and the TPA, respective calculation grids as defined by Australian Standard AS2560.2.1-2003 have been applied. Illuminance values and uniformity ratios have been calculated at 1.0 m above ground level. A maintenance factor of 0.8 has been applied.

** Radium.

MULTIPLE COURT SYSTEM – HIT

Club Competition

- Twelve poles
- 8 m mounting height

The multi-court system provides competition quality play for clubs as well as hotels, resorts, etc. The pole positions ensure safety for players. Courts can be switched individually, thereby allowing energy efficient and cost saving operation.

Statistics*	Outer PPA	Outer TPA	Inner PPA	Inner TPA
Eave	388 lx	379 lx	362 lx	367 lx
E _{max}	470 lx	519 lx	455 lx	509 lx
E _{min}	286 lx	252 lx	259 lx	259 lx
U ₁	0.74	0.66	0.71	0.70
U ₂	0.61	0.49	0.57	0.51

Equipment list	Quantity	
138-9302	SBL480 [A60] tennis court luminaire	18
270-9200	TM-C 80 140.1 pole	6
270-9201	TM-C 80 140.2B pole	2
270-9202	TM-C 80 140.2L pole	4
TE8706	HRI-T 1000W/N/Sc/E40** high output metal halide lamp	18

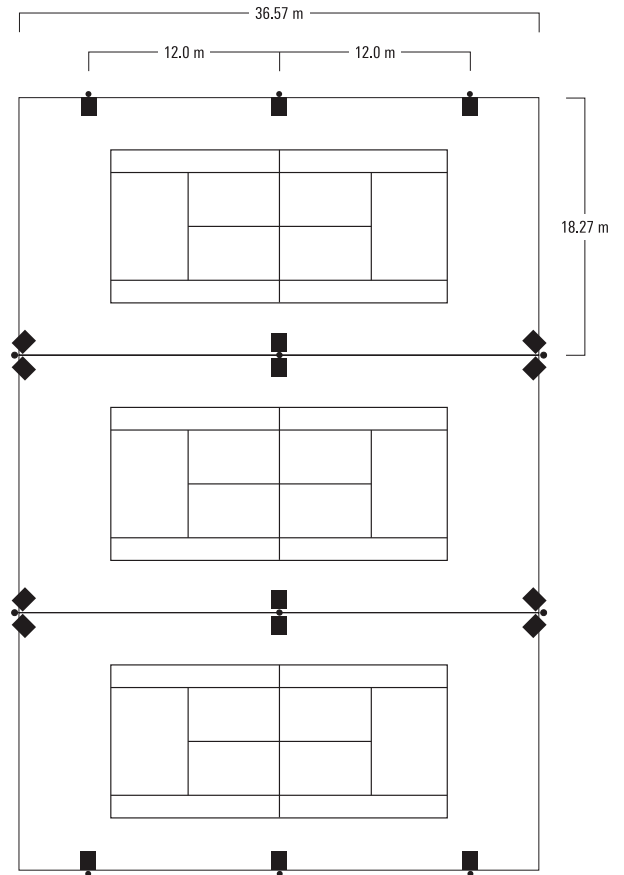

* The principal playing area (PPA) is defined as the lined area, measuring 10.97 m x 23.77 m. The total playing area (TPA) covers the larger area of action and typically measures 18.27 m x 36.57 m. For both the PPA and the TPA, respective calculation grids as defined by Australian Standard AS2560.2.1-2003 have been applied. Illuminance values and uniformity ratios have been calculated at 1.0 m above ground level. A maintenance factor of 0.8 has been applied.

** Radium.



CREATIVE DESIGNS
IN LIGHTING



6582 N. 78th St., Suite A
Scottsdale, Arizona 85260
602.340.9322
design@cdli.com
www.cdli.com
1976-44-2022
years of architectural
lighting design

SCOTTSDALE PLAZA
7200 N. SCOTTSDALE RD., PARADISE VALLEY



SYMBOL	DESCRIPTION
XXXXXX	XXXXXXXXXX
▲	▲
▲	▲
▲	▲

DATE: _____
SCALE: 1/8" = 1'-0"
PROJECT NUMBER: _____
DESIGN BY: _____
CHECKED BY: _____
SHEET NUMBER: _____

LIGHTING
PHOTOMETRICS

SL1

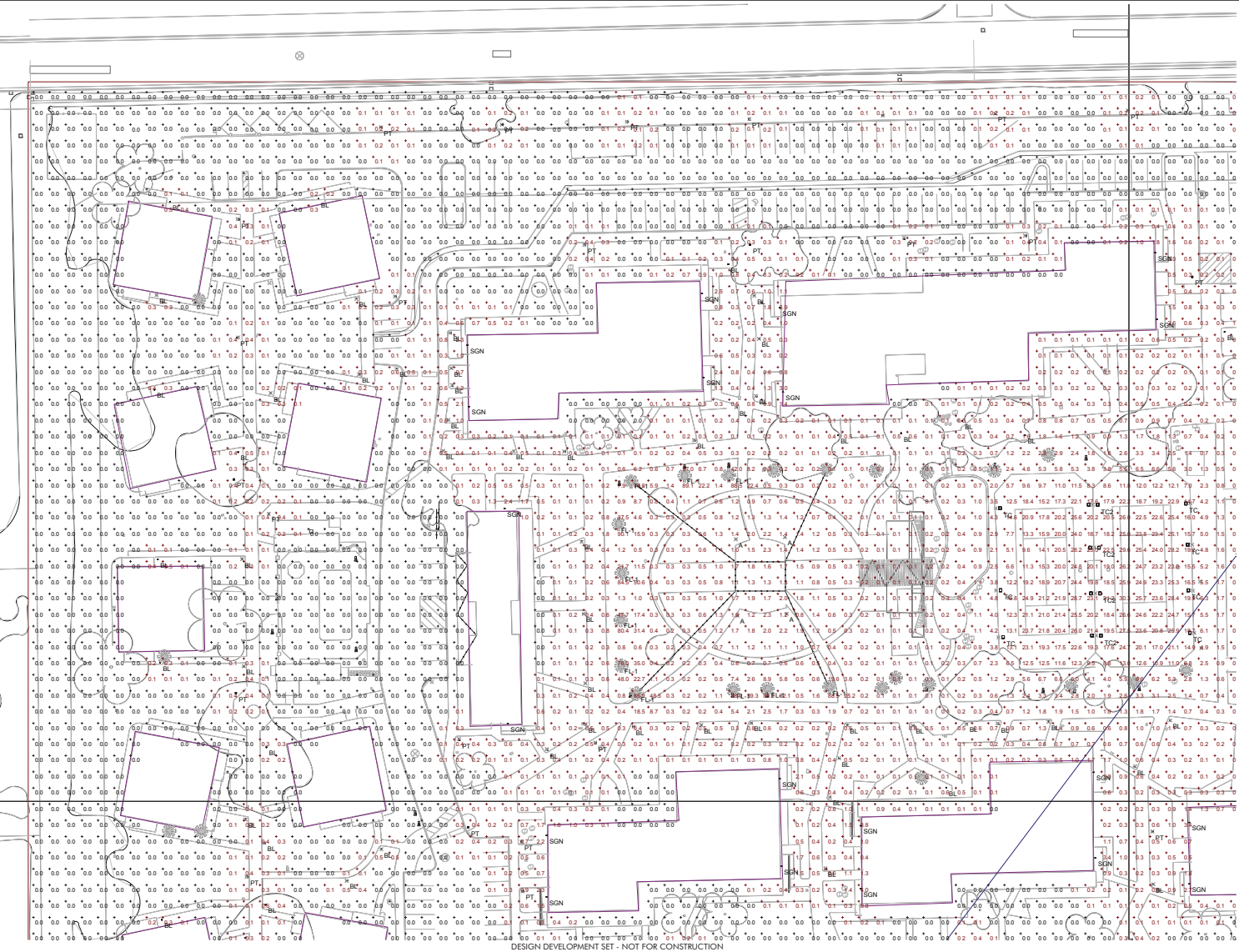

DESIGN DEVELOPMENT SET - NOT FOR CONSTRUCTION



**CREATIVE DESIGNS
IN LIGHTING**



5582 N. 78th St. Suite A
Scottsdale, Arizona 85260
602.940.8822
design@cdli.com
www.cdli.com

1976 44 2022
years of architectural
lighting design

SCOTTSDALE PLAZA
7700 N. SCOTTSDALE RD., PARADISE VALLEY

REVISIONS	
1	XX
2	
3	
4	

DATE: _____

SCALE: _____

PROJECT NUMBER: _____

DRAWN BY: _____

CHECKED BY: _____

SHEET NUMBER: _____

**LIGHTING
PHOTOMETRICS**

SHEET NUMBER: _____

SL2

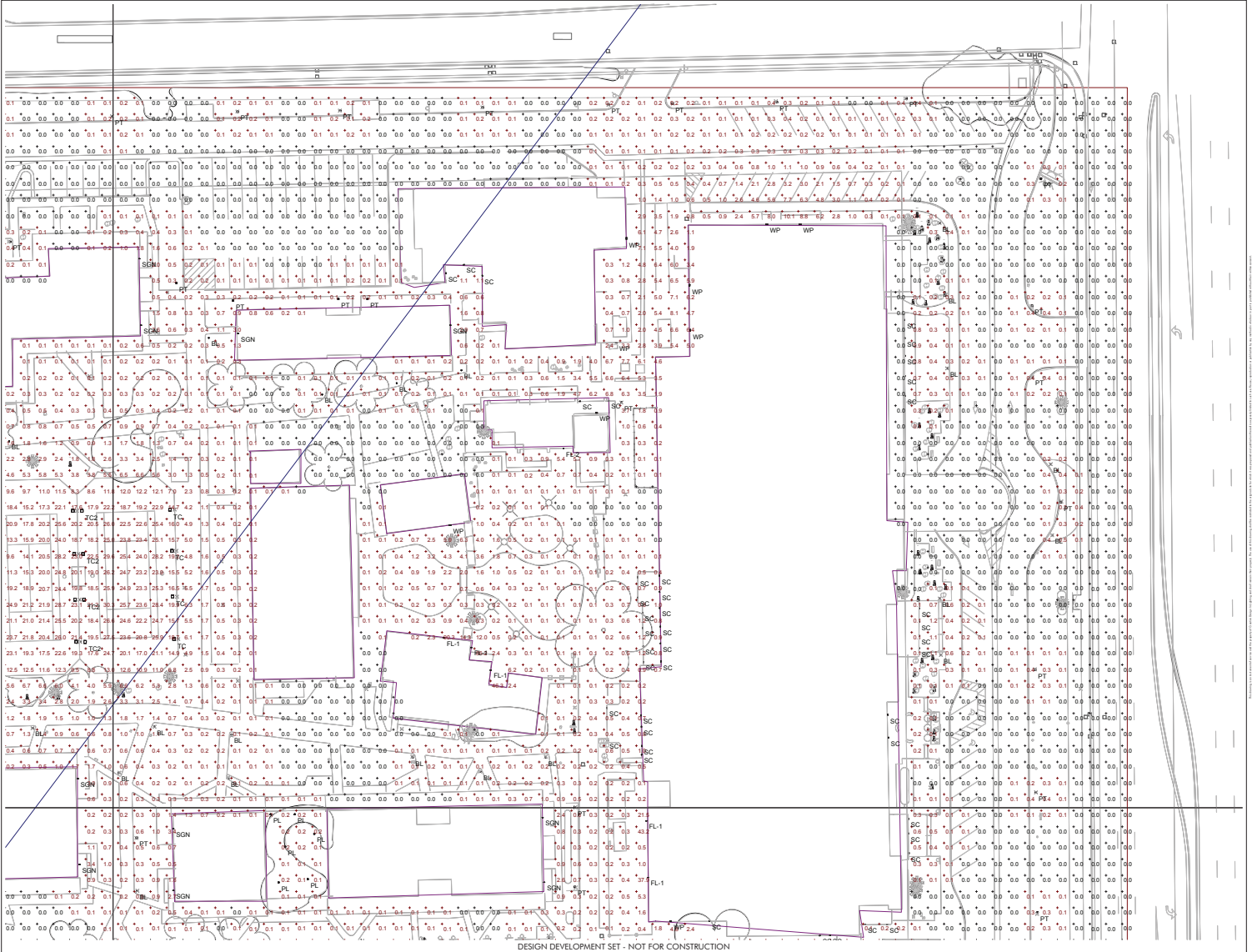

DESIGN DEVELOPMENT SET - NOT FOR CONSTRUCTION



CREATIVE DESIGNS
IN LIGHTING



5582 N. 78th St, Suite A
Scottsdale, Arizona 85260
602.340.9222
design@cdlph.com
www.cdlph.com

1974-44-2022
years of architectural
lighting design

SCOTTSDALE PLAZA
7200 N. SCOTTSDALE RD., PARADISE VALLEY

REVISIONS	
1	XXXXXXXXXX

DATE	
SCALE	
PROJECT NUMBER	
DRAWING TITLE	
DESIGNED BY	
DRAWN BY	

LIGHTING
PHOTOMETRICS

SHEET NUMBER
SL3

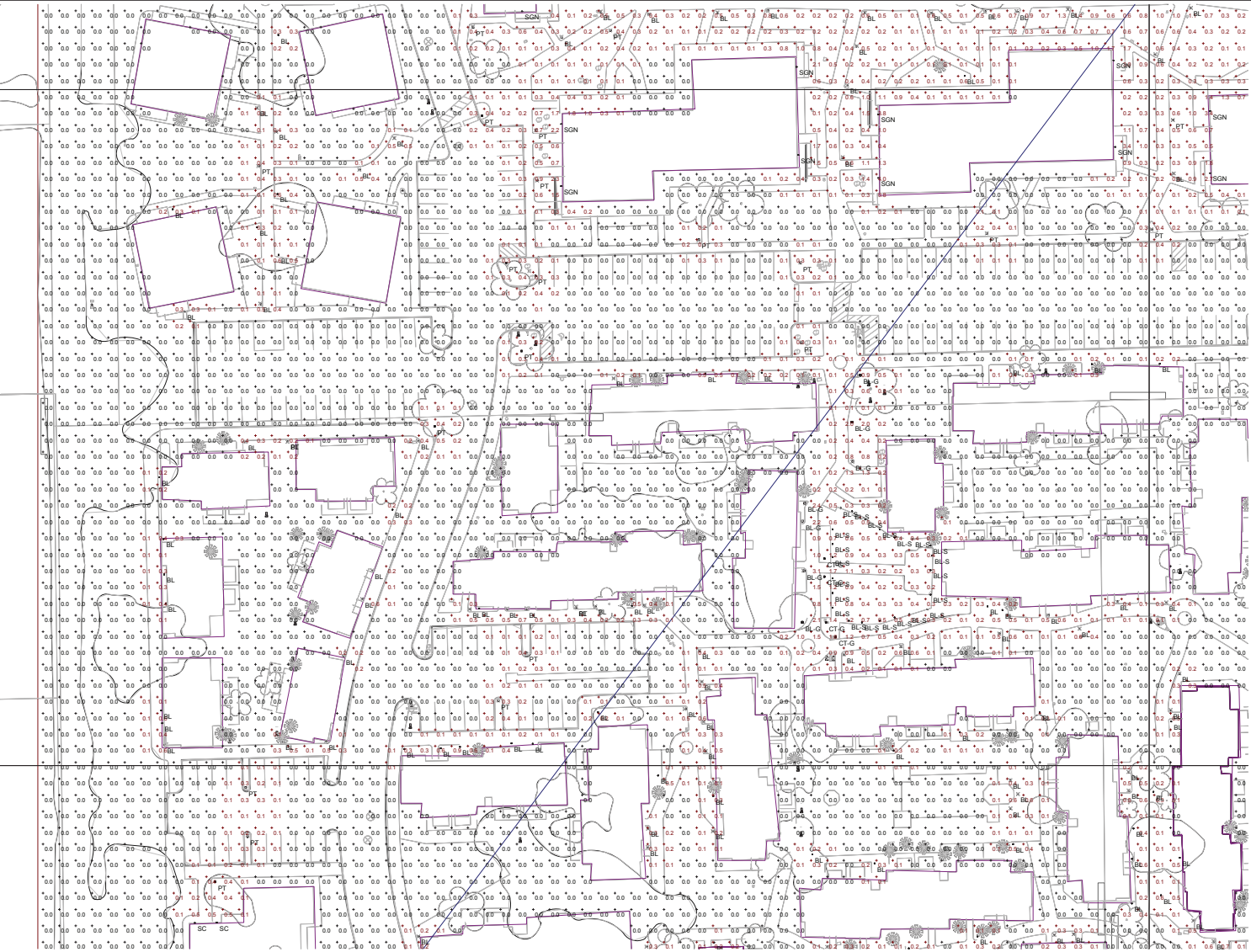

DESIGN DEVELOPMENT SET - NOT FOR CONSTRUCTION

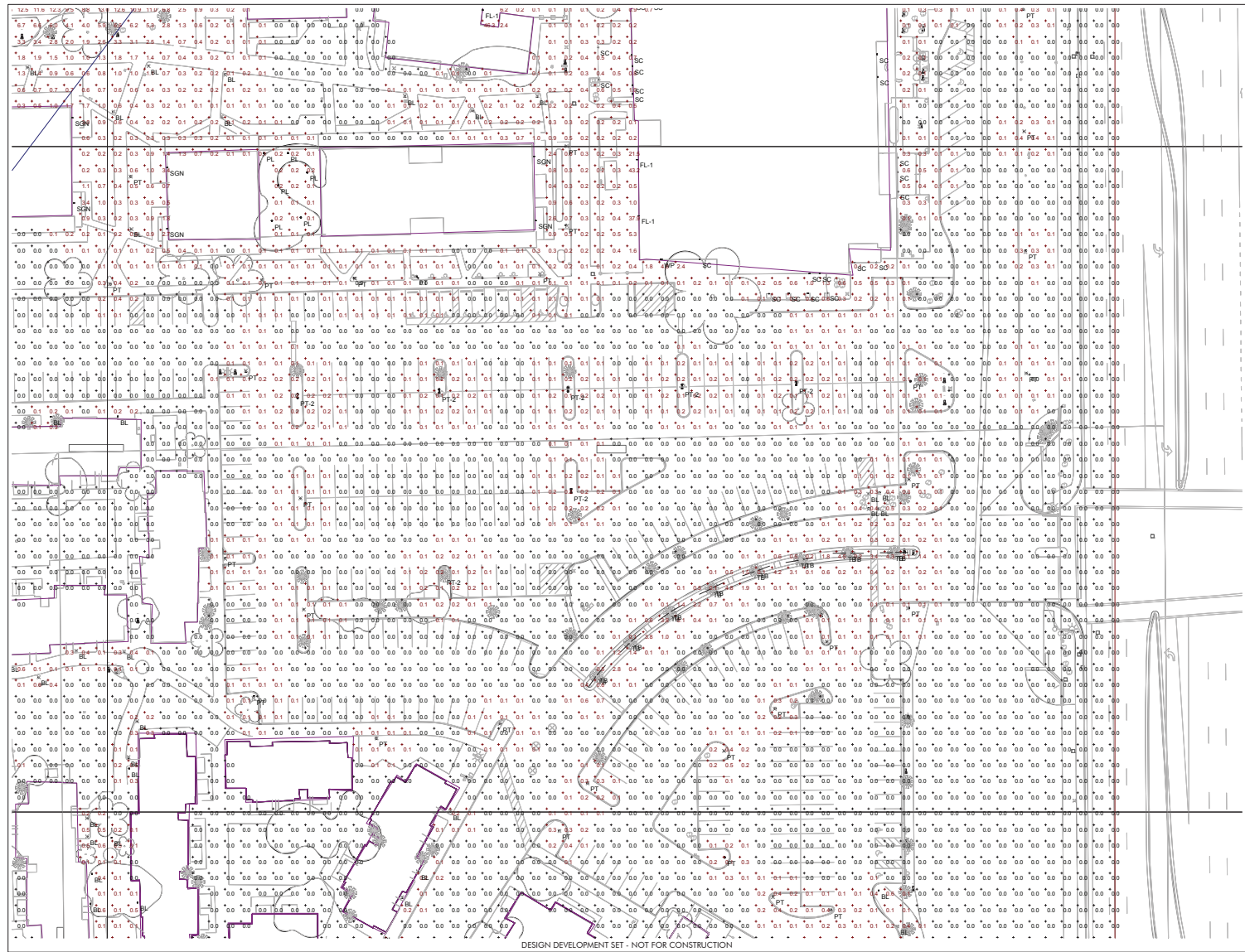

**CREATIVE DESIGNS
IN LIGHTING**

5582 N. 78th St., Suite A
Scottsdale, Arizona 85260
602.940.8022
design@cdli.com
www.cdli.com

1978 44 2022
years of architectural
lighting design

SCOTTSDALE PLAZA
7200 N. SCOTTSDALE RD., PARADISE VALLEY

REVISIONS	
1	XX
2	
3	
4	
5	

DATE: _____
 SCALE: 1/4" = 1'-0"
 REVISION NUMBER: _____
 DRAWN BY: _____
 CHECKED BY: _____
 SHEET NUMBER: _____

**LIGHTING
PHOTOMETRICS**

SL4



CREATIVE DESIGNS
IN LIGHTING



5582 N. 73th St., Suite A
Scottsdale, Arizona 85260
602.340.9322
design@cdli.com
www.cdli.com

1975 44 2022
years of architectural
lighting design

SCOTTSDALE PLAZA
7200 N. SCOTTSDALE RD., PARADISE VALLEY



SYMBOL	DESCRIPTION
XXXXXX	XX
▲	
▲	
▲	

DATE	
SCALE	
PROJECT NUMBER	
DESIGN BY	
CHECKED BY	
DRAWN BY	

LIGHTING
PHOTOMETRICS

SHEET NUMBER
SL5

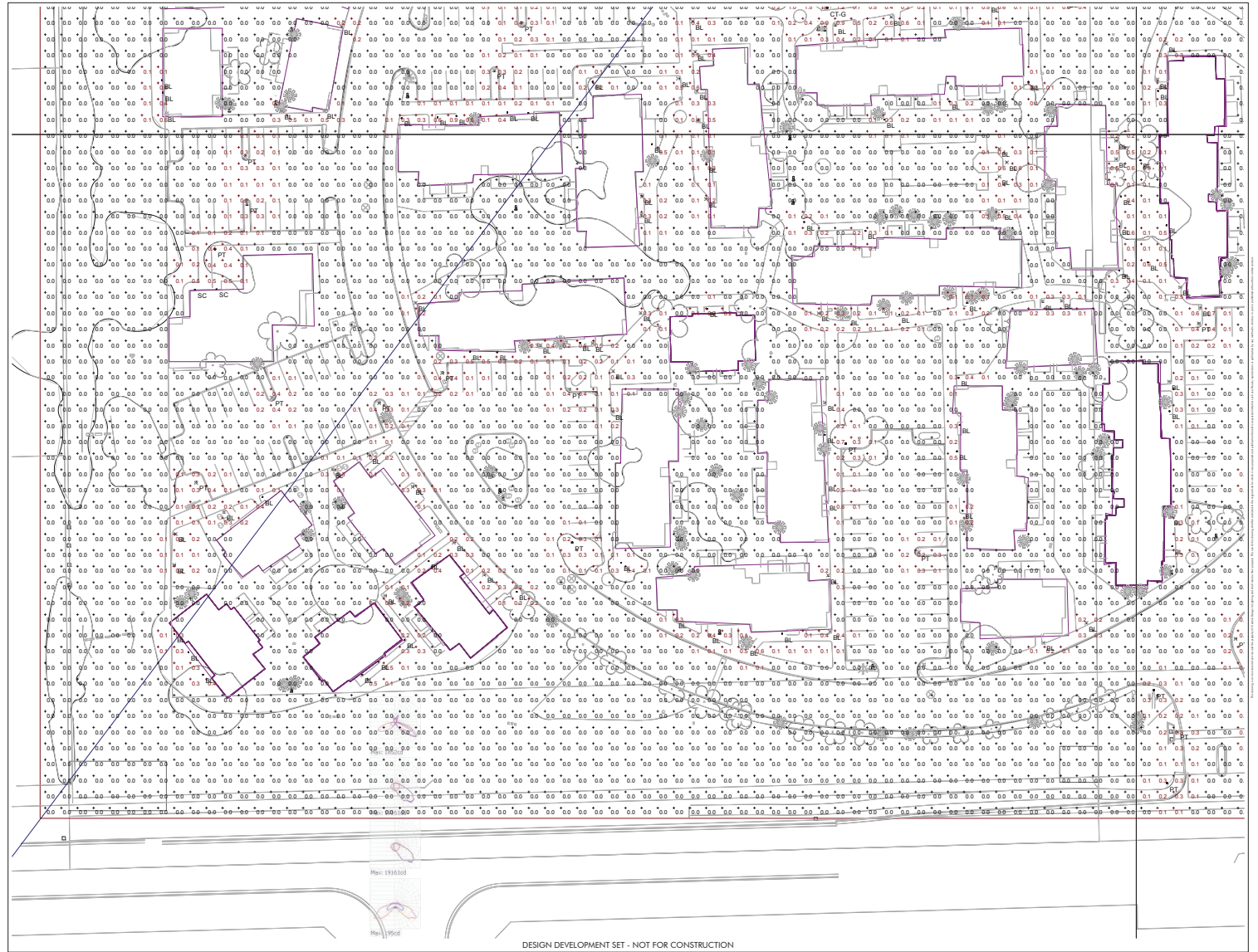



**CREATIVE DESIGNS
IN LIGHTING**

6592 N. 73th St. Suite A
Scottsdale, Arizona 85260
602.340.9322
design@cdli.com
www.cdli.com

1975 44 2022
years of architectural
lighting design

SCOTTSDALE PLAZA
7200 N SCOTTSDALE RD, PARADISE VALLEY

REVISION	DATE
1	11/11/22
2	11/11/22
3	11/11/22
4	11/11/22
5	11/11/22
6	11/11/22
7	11/11/22
8	11/11/22
9	11/11/22
10	11/11/22
11	11/11/22
12	11/11/22
13	11/11/22
14	11/11/22
15	11/11/22
16	11/11/22
17	11/11/22
18	11/11/22
19	11/11/22
20	11/11/22
21	11/11/22
22	11/11/22
23	11/11/22
24	11/11/22
25	11/11/22
26	11/11/22
27	11/11/22
28	11/11/22
29	11/11/22
30	11/11/22
31	11/11/22
32	11/11/22
33	11/11/22
34	11/11/22
35	11/11/22
36	11/11/22
37	11/11/22
38	11/11/22
39	11/11/22
40	11/11/22
41	11/11/22
42	11/11/22
43	11/11/22
44	11/11/22
45	11/11/22
46	11/11/22
47	11/11/22
48	11/11/22
49	11/11/22
50	11/11/22
51	11/11/22
52	11/11/22
53	11/11/22
54	11/11/22
55	11/11/22
56	11/11/22
57	11/11/22
58	11/11/22
59	11/11/22
60	11/11/22
61	11/11/22
62	11/11/22
63	11/11/22
64	11/11/22
65	11/11/22
66	11/11/22
67	11/11/22
68	11/11/22
69	11/11/22
70	11/11/22
71	11/11/22
72	11/11/22
73	11/11/22
74	11/11/22
75	11/11/22
76	11/11/22
77	11/11/22
78	11/11/22
79	11/11/22
80	11/11/22
81	11/11/22
82	11/11/22
83	11/11/22
84	11/11/22
85	11/11/22
86	11/11/22
87	11/11/22
88	11/11/22
89	11/11/22
90	11/11/22
91	11/11/22
92	11/11/22
93	11/11/22
94	11/11/22
95	11/11/22
96	11/11/22
97	11/11/22
98	11/11/22
99	11/11/22
100	11/11/22

DATE: 11/11/22
 PROJECT NUMBER:
 DRAWN BY:
 CHECKED BY:
 SHEET NUMBER:
**LIGHTING
PHOTOMETRICS**
 SHEET NUMBER:
SL6



DESIGN DEVELOPMENT SET - NOT FOR CONSTRUCTION

TYPE 'PT'
POST TOP FIXTURE
MEASURED LIGHT LEVEL
ISOMETRIC LINES

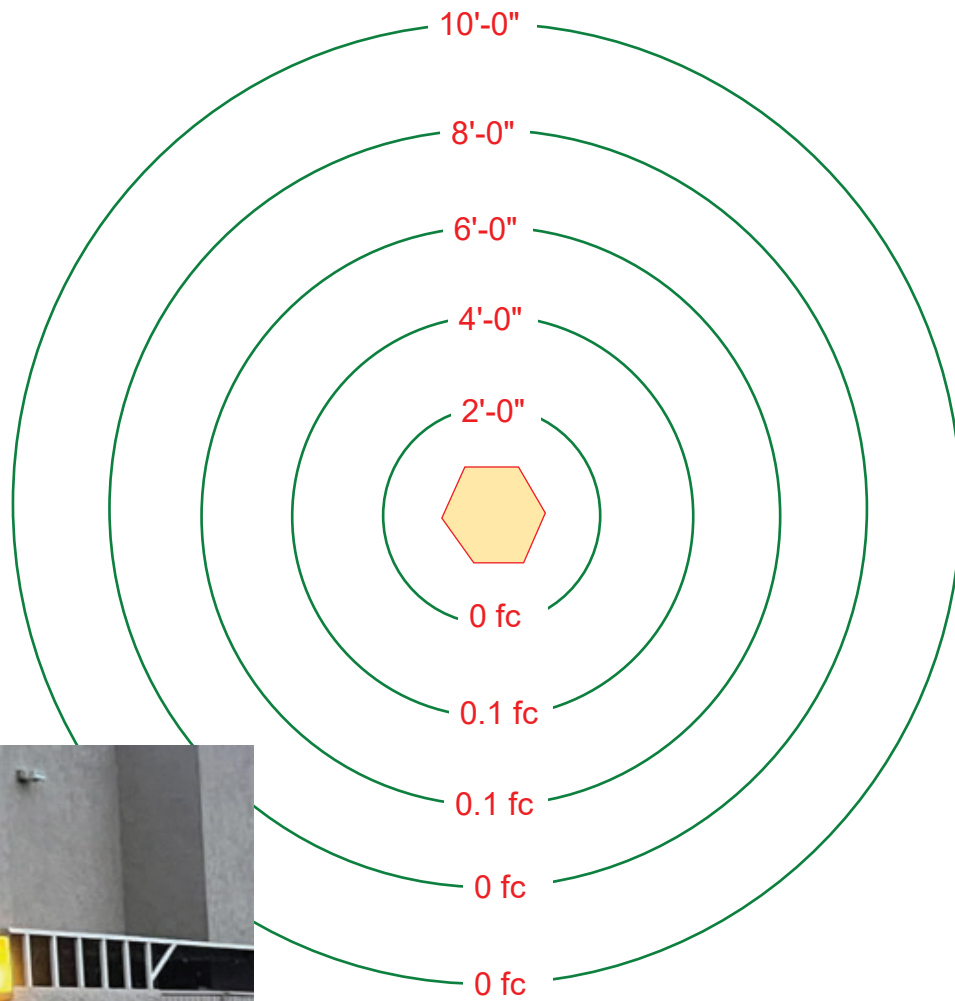

TYPE 'PT-2'
POST TOP FIXTURE
MEASURED LIGHT LEVEL
ISOMETRIC LINES

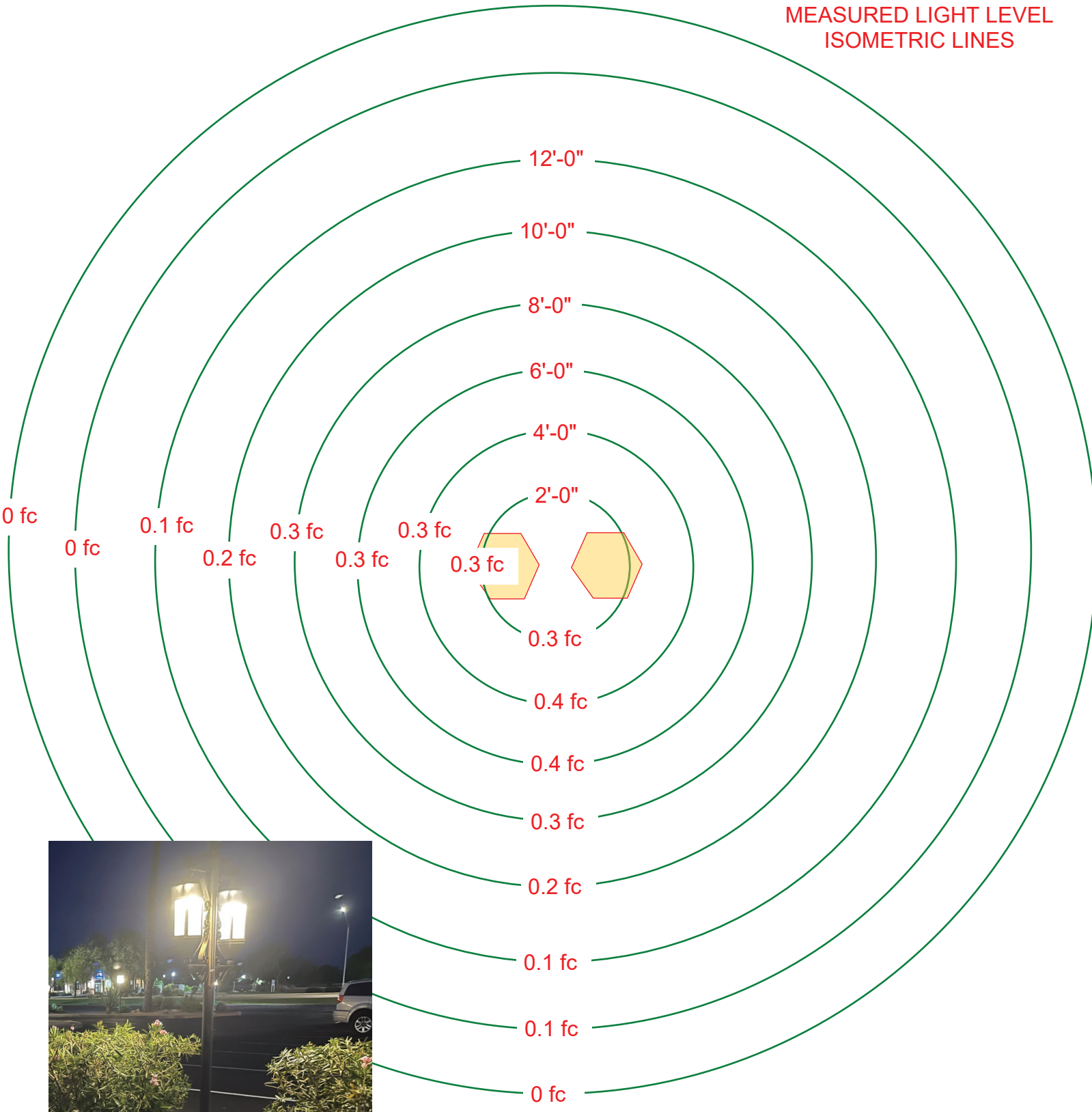

TYPE 'BL'
BOLLARD
MEASURED LIGHT LEVEL
ISOMETRIC LINES

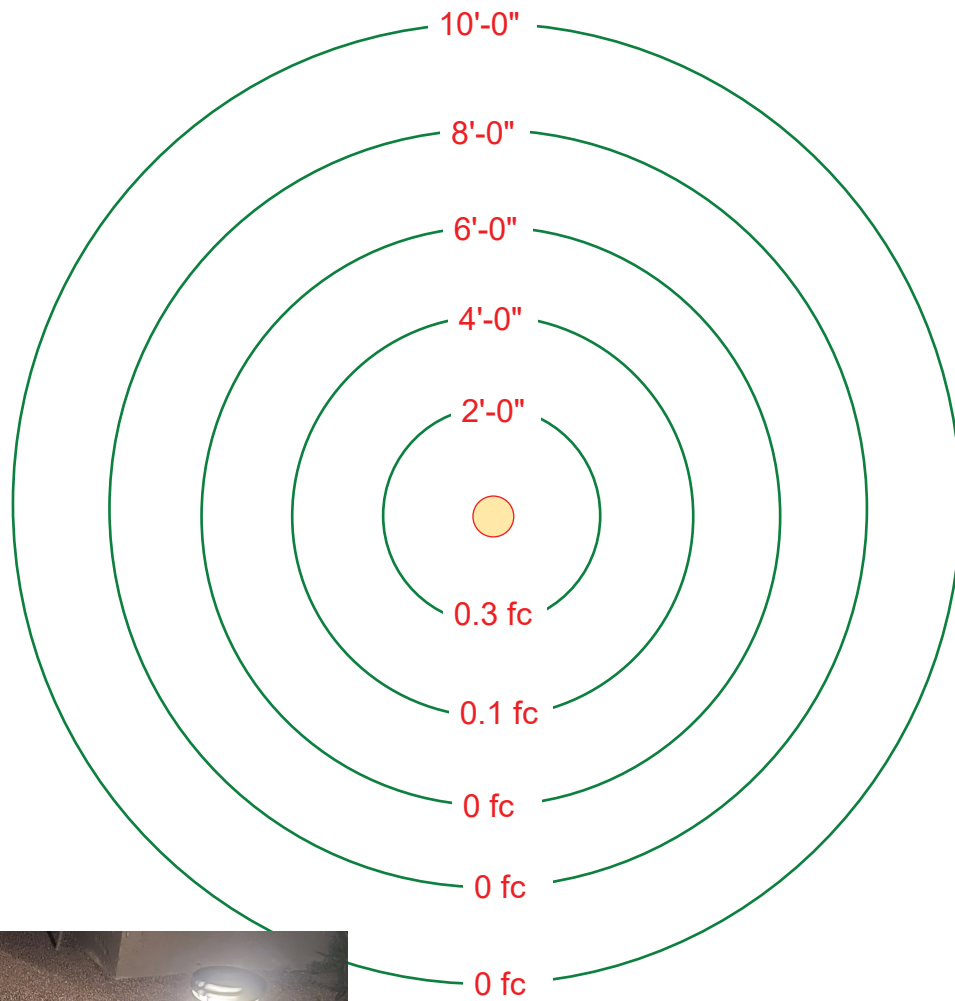

TYPE 'TC' AND 'TC-2'
TENNIS COURT LIGHTS
MEASURED LIGHT LEVEL
ISOMETRIC LINES

