

***Paradise Valley Watershed Study
Cheney Watershed
Alternatives Analysis Report***

Dibble Project No.: 1015079

February 9, 2017

Submitted To:



**Dibble
Engineering®**

7500 North Dreamy Draw Drive
Suite 200
Phoenix, Arizona 85020
P. 602.957.1155
F. 602.957.2838
www.dibblecorp.com

PRELIMINARY

SUBMITTAL



Table of Contents

Executive Summary	1
I. Introduction	3
A. Purpose	3
B. Scope of the Project.....	3
C. Study Area.....	3
II. Previous Studies	5
III. Results of Public Outreach	5
IV. Approach to Alternatives Development	6
A. Constraints.....	6
B. Opportunities.....	7
C. Process	7
1. Improvement Areas and Preliminary Alternatives.....	7
2. Facility Sizing and Opinion of Probable Construction Costs.....	8
3. Preliminary Modeling of Alternatives	9
V. Drainage Improvement Alternatives	11
A. Cheney Improvement Area – Alternative: Cheney 1	11
1. Description	11
2. Performance	13
3. Advantages and Disadvantages.....	14
B. Cheney Improvement Area – Alternative: Cheney 2	15
1. Description	15
2. Performance	15
3. Advantages and Disadvantages.....	18
C. Cheney Improvement Area – Alternative: Cheney 3	19
1. Description	19
2. Performance	21
3. Advantages and Disadvantages.....	23
D. Mockingbird Improvement Area – Alternative: Mockingbird 1	24
1. Description	24
2. Performance	24
3. Advantages and Disadvantages.....	28
E. Mockingbird Improvement Area – Alternative: Mockingbird 2	29
1. Description	29
2. Performance	29
3. Advantages and Disadvantages.....	32
F. Mockingbird Improvement Area – Alternative: Mockingbird 3	33
1. Description	33
2. Performance	33
3. Advantages and Disadvantages.....	35
G. Quartz Mountain Improvement Area – Alternatives: Quartz Mountain 1, Quartz Mountain 2, and Quartz Mountain 3	36
1. Description	36

2. Performance.....	41
3. Advantages and Disadvantages.....	42
H. Maverick Improvement Area – Alternative: Maverick 1	43
1. Description	43
2. Performance.....	43
3. Advantages and Disadvantages.....	45
I. Maverick Improvement Area – Alternative: Maverick 2	46
1. Description	46
2. Performance.....	46
3. Advantages and Disadvantages.....	49
VI. Evaluation of Alternatives	50
A. Performance Criteria.....	50
1. Stormwater Management Effectiveness.....	50
2. Cost.....	51
3. Public Acceptance	51
4. Constructability / Construction Phasing.....	52
B. Evaluation Matrices	53
C. Next Steps	53
VII. References.....	54

List of Figures

Figure 1 – Location Map.....	4
Figure 2 – Vicinity Map	4
Figure 3 – Example of Solicited Public Outreach Comments.....	5
Figure 4 – Cheney Watershed – Improvement Areas Key Map.....	8
Figure 5 – Alternative: Cheney 1.....	12
Figure 6 – Alternative: Cheney 2.....	17
Figure 7 – Alternative: Cheney 3.....	20
Figure 8 – Cheney Channel Typical Section with Storm Drain Overflow Inlet (Facing East).....	21
Figure 9 – Cheney Channel Typical Driveway Culvert (Facing East)	21
Figure 10 – Alternative: Mockingbird 1	26
Figure 11 – Alternative: Mockingbird 2	30
Figure 12 – Alternative: Mockingbird 3	34
Figure 13 – Hillside Sediment Collection Ditch with Storm Drain Inlet (Facing East)	37
Figure 14 – Alternative: Quartz Mountain 1.....	38
Figure 15 – Alternative: Quartz Mountain 2.....	39
Figure 16 – Alternative: Quartz Mountain 3.....	40
Figure 17 – Alternative: Maverick 1.....	44
Figure 18 – Alternative: Maverick 2.....	47

List of Tables

Table 1 – Cheney 1 Flow Depth Reduction of Remaining Floodprone Buildings.....	13
Table 2 – Cheney 1 Street Flooding Reduction.....	13
Table 3 – Cheney 2 Flow Depth Reduction of Remaining Floodprone Buildings.....	16
Table 4 – Cheney 2 Street Flooding Reduction.....	16
Table 5 – Cheney 3 Flow Depth Reduction of Remaining Floodprone Buildings.....	22
Table 6 – Cheney 3 Street Flooding Reduction.....	22
Table 7 – Mockingbird 1 Flow Depth Reduction of Remaining Floodprone Buildings	27
Table 8 – Mockingbird 1 Street Flooding Reduction.....	27
Table 9 – Mockingbird 2 Flow Depth Reduction of Remaining Floodprone Buildings	31
Table 10 – Mockingbird 2 Street Flooding Reduction.....	31
Table 11 – Mockingbird 3 Flow Depth Reduction of Remaining Floodprone Buildings	33
Table 12 – Mockingbird 3 Street Flooding Reduction.....	35
Table 13 – Maverick 1 Flow Depth Reduction of Remaining Floodprone Buildings.....	43
Table 14 – Maverick 1 Street Flooding Reduction	45
Table 15 – Maverick 2 Flow Depth Reduction of Remaining Floodprone Buildings.....	48
Table 16 – Maverick 2 Street Flooding Reduction	48

Appendices – Bound Separately

Appendix A – Existing Facilities & Utilities Map
Appendix B – Cheney Watershed Preliminary Alternatives (May 2016)
Appendix C – 100-Year Modeled Alternatives Inundation Maps
Appendix D – 10-Year Modeled Alternatives Inundation Maps
Appendix E – 10-Year Storm Depth Reduction Maps
Appendix F – Facility Sizing & Cost Calculations
Appendix G – Alternatives Cost Summary
Appendix H – Evaluation Matrices



Executive Summary

As a consequence of large storm events in recent years, Dibble Engineering (Dibble) is conducting engineering analyses of the Cheney Watershed on behalf of the Town of Paradise Valley (Town). The purpose of these studies is to analyze available hydrologic models of the watersheds and identify system-wide and localized flooding-related hazards. Additionally, Public Information and Outreach (PIO) efforts have been conducted to keep area stakeholders and residents informed, solicit their input in the identification of flooding hazards, and gauge their tolerance to flooding risk.

The previous phase, *Hazards Identification*, evaluated the 2-dimensional modeling of the Cheney Watershed recently completed by the Flood Control District of Maricopa County (FCDMC). Revisions were made to the model to more closely investigate the locations of probable flooding. The results of the model were then combined with anecdotal information obtained from Town staff and significant public outreach to Town residents. This resulted in mapped locations of known/suspected scour & sedimentation, and flood inundation for the 10-year and 100-year recurrence intervals.

In this *Alternatives Analysis*, the flood hazard locations identified in the *Hazards Identification Memorandum* were grouped into improvement areas; known as: Cheney, Maverick, Mockingbird and Quartz Mountain. Potential drainage improvements were then proposed and discussed with Town and FCDMC staff for initial feasibility. Resulting potential improvements were then presented to the public at an open meeting on May 18, 2016 for the purpose of soliciting initial feedback from the public. That information was then used to help guide the location and nature of drainage improvements to be studied further.

This report outlined the methodologies, findings and recommendations of drainage improvements for the Town's consideration.

Each improvement was 2-dimensionally modeled to estimate its effectiveness. Additionally, separate improvements, proposed by the FCDMC, were included in the modeling to estimate their effects combined with the improvements proposed herein. The possible benefit to mitigate flooding was derived and an opinion of probable construction costs were assessed.

Following is a summary of the estimated project costs and benefit for each alternative.

Alternative	Estimated Cost	Benefit (Structures No Longer Inundated)	
		10-Year Storm	100-Year Storm
		Cheney 1...or	\$3.9M
Cheney 2...or	\$4.7M	20 (out of 20)	20 (out of 63)
Cheney 3	\$6.6M	20 (out of 20)	23 (out of 63)
Mockingbird 1...or	\$4.9M	5 (out of 7)	4 (out of 25)
Mockingbird 2...or	\$5.6M	5 (out of 7)	4 (out of 25)
Mockingbird 3	\$1.5M	5 (out of 7)	1 (out of 25)
Quartz Mntn 1...or	\$3.0M	N/A	N/A
Quartz Mntn 2...or	\$3.1M	N/A	N/A
Quartz Mntn 3	\$3.1M	N/A	N/A
Maverick 1...or	\$2.6M	5 (out of 9)	2 (out of 25)
Maverick 2	\$3.5M	7 (out of 9)	2 (out of 25)

An evaluation matrix was then used to compare and rank each potential improvement. The results of this evaluation as completed by Dibble Engineering is included in **Appendix H**. Additionally, a HAZUS analysis was performed to estimate the value of the benefit (in dollars, flooding damage to buildings and contents only) for each alternative. After consultation with Town staff, the alternatives were grouped into four Options.

		10-Year Event			100-Year Event		
		*Flood Protection Benefit	Benefit/Cost Ratio	**Life Cycle B/C Ratio	*Flood Protection Benefit	Benefit/Cost Ratio	**Life Cycle B/C Ratio
Option	CIP Cost						
1 - Do Nothing	\$0M	\$0M	0.0	0.0	\$0M	0.0	0.0
2 - Least Costly	\$11M	\$6.2M	0.6	4.2	\$8.5M	0.8	0.6
3 - Most Costly	\$19M	\$6.5M	0.3	2.6	\$11.7M	0.6	0.5
4 - Use New Data	\$0M	\$0M	0.0	0.0	\$0M	0.0	0.0

* For structures and contents only. No benefit estimated for public infrastructure and public/private landscaping

** A 75-year life cycle was assumed

The final recommendations from this Alternatives Analysis will be used to develop a Capital Improvement Program (CIP) to help guide the Town's budgeting processes.

I. Introduction

A. Purpose

Dibble has developed drainage improvements alternatives intended to provide the Town with options for the mitigation of the previously identified flooding hazards. The purpose of this Alternatives Analysis is to help provide an objective evaluation and relative ranking of the alternatives for the Town to consider including in future Capital Improvement Plans.

B. Scope of the Project

The tasks completed during the creation of this Alternatives Analysis include:

- Developing a preliminary list of possible drainage improvements (alternatives) for discussion with Town staff and during public meetings;
- Modeling the alternatives using FLO-2D to estimate their effectiveness at mitigating flooding for multiple levels of protection;
- Developing benefit metrics to measure the alternatives effectiveness;
- Creating maps to portray the results of the modeling;
- Creating Engineer's Opinions of Probable Construction Costs (EOPCC) for each alternative;
- Developing a set of comparative scoring criteria;
- Conducting an objective comparative evaluation and ranking of the alternatives using the scoring criteria;
- Making a recommendation as to the best alternatives to include in future Capital Improvement Plans;
- Acquire new knowledge of flood conditions in the watershed, and facilitate Mayor and Council discussions on how to manage such storm water threats.

It should be noted that the alternatives presented herein are meant to coincide and compliment other potential drainage improvements currently being investigated by the FCDMC. **Since this Alternatives Analysis will likely be completed prior to the FCDMC's planning-level efforts, future coordination is recommended prior to the potential implementation of the Town's improvements.**

C. Study Area

The Cheney Watershed is located in the central portion of the Town of Paradise Valley (shown in red on **Figure 1**). It is also located within the study area of the FCDMC's *Lower Indian Bend Wash Area Drainage Master Study/Plan (LIBW ADMS/P)*. As previously mentioned, the FLO-2D modeling for the Cheney Watershed was derived from the LIBW ADMS/P FLO-2D model and significant coordination has taken place between the Town, FCDMC, and Dibble to minimize or eliminate duplication of effort in studying the Cheney Watershed and LIBW ADMS/P (see **Section II**).

Once the Cherokee Wash Watershed has been analyzed (northwest of the Cheney Watershed shown in **Figure 1** below), this coordination will also be conducted with respect to the FCDMC's upcoming *Middle Indian Bend Wash Area Drainage Master Study/Plan (MIBW ADMS/P)*.

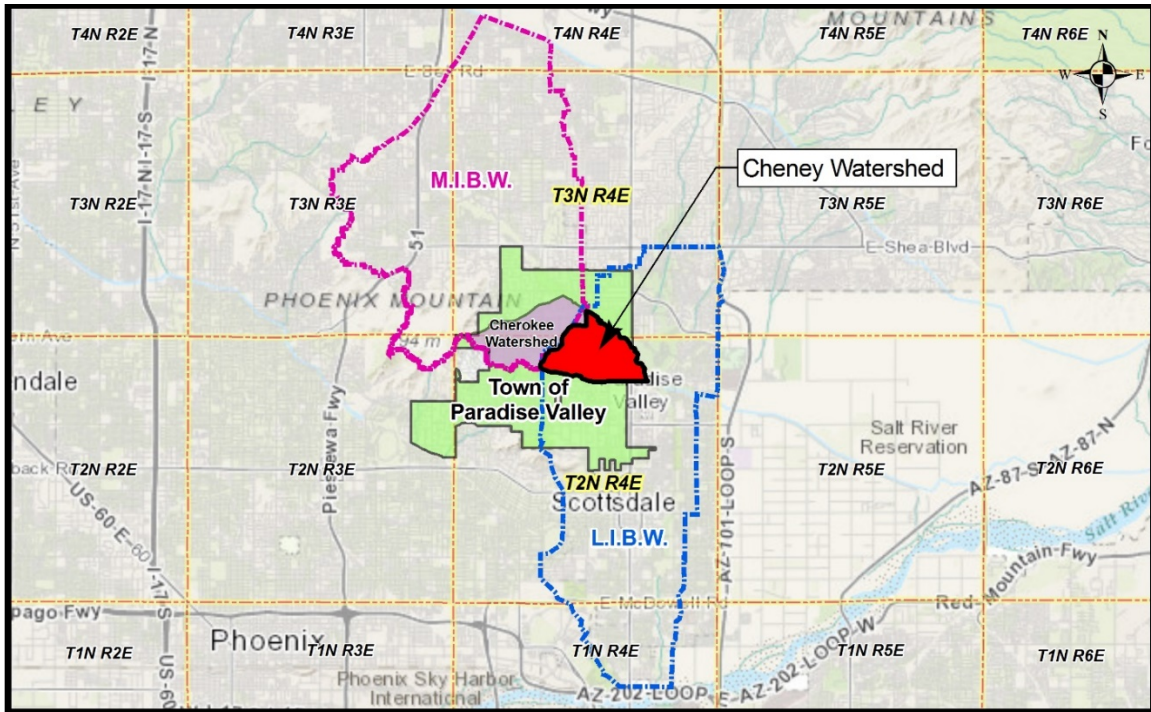

Figure 1 – Location Map

The Cheney Watershed is generally bounded by Indian Bend Wash to the east, Indian Bend Road to the south, and Mummy Mountain to the west and north (see Figure 2).



Figure 2 – Vicinity Map

II. Previous Studies

This Cheney Watershed Study falls within the geographic limits of the FCDMC's *Lower Indian Bend Wash ADMS/P* (see **Figure 1 – Location Map**). That LIBW ADMS/P began in 2012 and the FCDMC has completed the existing conditions FLO-2D modeling and hazards identification phases. The FCDMC has also identified some possible projects intended to alleviate flooding hazards. These have been incorporated into the existing conditions FLO-2D model for this Cheney Watershed Alternatives Analysis to ensure that proper coordination between the Town's and FCDMC's improvements efforts.

Dibble previously completed the *Paradise Valley Cheney Watershed Hazards Identification Memorandum* in March, 2016. This document summarized the identification and characterization of flooding hazards in the Cheney Watershed and is the basis for the development of the alternative solutions discussed herein.

III. Results of Public Outreach

Dibble Engineering, in conjunction with staff from the Town of Paradise Valley, conducted a public information meeting on December 8, 2015 for the purpose of explaining the project goals and scope of work as well as to solicit public input on the location and nature of known flood hazard areas. Along with other efforts, this information helped guide the development of solution alternatives which were then presented to the public at a meeting on May, 18, 2016. During that meeting, sketches of the locations and general nature of the alternatives were shown and feedback was solicited. That feedback was collected as notes and has helped inform this analysis (see **Figure 3**).

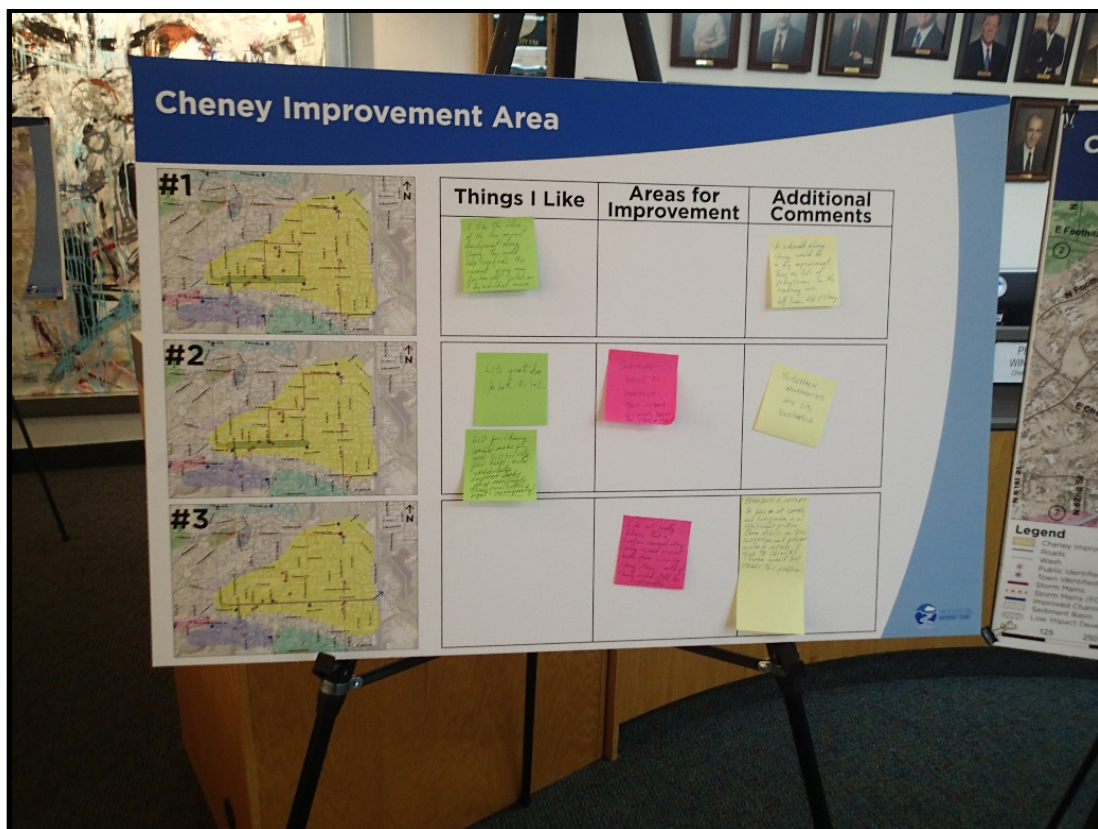

Figure 3 – Example of Solicited Public Outreach Comments

Future public outreach efforts will likely include the presentation of more detailed information (**opinion of probable construction** costs, modeling results, etc.) for the purpose to solicit additional information from the public.

IV. Approach to Alternatives Development

The primary objective of each of the stormwater management alternatives is to mitigate existing flooding potential and to reduce stormwater related maintenance for both Town residents and staff. The previously produced *Paradise Valley Cheney Watershed Hazards Identification Memorandum* includes an analysis of the existing watershed and identifies areas of highest importance. The reader is asked to refer to that document for the results of existing conditions modeling and hazard identification results. This Alternatives Analysis report was conducted to respond to the identified constraints within the watershed and seeks to take advantage of opportunities that were identified to add value. The constraints, opportunities, and process are further described herein. The stormwater alternatives that resulted from this process are provided in the following section.

A. Constraints

Stormwater mitigation constraints for the Cheney Watershed include existing high volume traffic corridors, very high land values, underground utilities, a high aesthetic standard, and narrow rights-of-way in mountainside areas.

Mockingbird Lane and Invergordon Road are primary collector streets within the watershed, providing the primary means for traffic to pass north and south. Smaller collector streets included Cheney Drive east of Mockingbird Lane, Hummingbird Lane, and Indian Bend Road.

Land values within this area of Paradise Valley are relatively high as compared to average values within the Phoenix Metro area. The planning level land acquisition dollar value used by the Town is \$26 per square foot. This constraint, in combination with few areas of undeveloped space on relatively flat grade, makes surface retention a relatively costly feature in this watershed.

Major existing utilities and existing facilities within the watershed are captured on two figures provided in **Appendix A: Existing Facilities & Utilities Map**. Significant utilities in the watershed included telecommunications fiber optic within Mockingbird Lane, Invergordon Road, and Scottsdale Road, 69kv high voltage transmission lines within Scottsdale Road, and large diameter natural gas ($\geq 3''$) within Cheney Drive, Mockingbird Lane, Invergordon Road, and Scottsdale Road. In addition, water and sewer facilities exist throughout the street network within the watershed.

Town residents expect a high aesthetic standard for proposed facilities within the Cheney Watershed. Most developed areas have preserved a natural desert landscape. Surface features such as channels and basins must be contextually sensitive to the existing character. This rules out rigid channel linings such as concrete even if they require less space and long term maintenance.

Finally, mountainside areas have roads that are relatively narrow with 50 feet wide existing rights-of-way. In most cases utilities exist in the rights-of-way as well. This constraint exists along Quartz Mountain Road and Hummingbird Lane in the southwest portion of the watershed.

B. Opportunities

One unique opportunity currently presents itself to the Cheney Watershed. The FCDMC is currently developing regional stormwater management alternatives as part of the *Lower Indian Bend Wash Area Drainage Master Study/Plan*. The LIBW ADMS/P encompasses the Cheney Watershed as well as portions of the City of Phoenix and the City of Scottsdale. The fact that both studies are occurring at the same time provides an opportunity for sharing of information, collaboration, and augmentation of alternatives such that both a regional and local perspective is brought to the planning process. Many of the alternatives proposed with this document represent complimentary facilities to the preliminary alternatives developed by the FCDMC.

The second opportunity is related to topography. Much of the developed area of the watershed exhibits a healthy grade toward Lower Indian Bend Wash. The grade generally varies between 0.5% and 2% along the roadway corridors in the valley areas. These grades lend themselves to efficiently operating conveyance systems, particularly underground systems. The proximity to Lower Indian Bend Wash, providing a suitable gravity outfall, further supports alternatives with underground conveyance elements.

C. Process

1. Improvement Areas and Preliminary Alternatives

The Dibble project team conducted an in-house charrette to synthesize the existing conditions, constraints, and opportunities into stormwater management solutions. A watershed map was used with the existing storm drain systems, existing utilities, public and Town identified flooding problem areas, FLO-2D inundation results, and preliminary FCDMC planned facilities overlaid. Efforts were concentrated in the areas that the Hazard ID process indicated were of highest importance. From this effort, 14 unique stormwater protection features were identified as seed ideas. These ideas were then shared with Town staff and representatives from the FCDMC for collaboration and feedback. The seed ideas were then refined and grouped into 6 Improvement Areas, with competing alternatives within each. An additional 3 spot improvements (small, localized improvements meant to solve drainage problems of limited size), without competing alternatives, were identified. These Preliminary Alternatives were again shared with the Town and FCDMC on April 5, 2016 for collaboration and feedback. They were then presented to Town public as part of a May 18, 2016 public meeting where feedback and additional ideas were collected. The Preliminary Alternatives presented to the public are provided as **Appendix B**. Finally, using the information provided by the Town and residents, the potential alternatives were reduced to the final 11 alternatives to be included in the evaluation and selection process. These alternatives are within 4 Improvement Areas: *Cheney, Mockingbird, Quartz Mountain, and Maverick* (see **Figure 4**). These remaining alternatives were then sized and evaluated using the results of FLO-2D modeling.

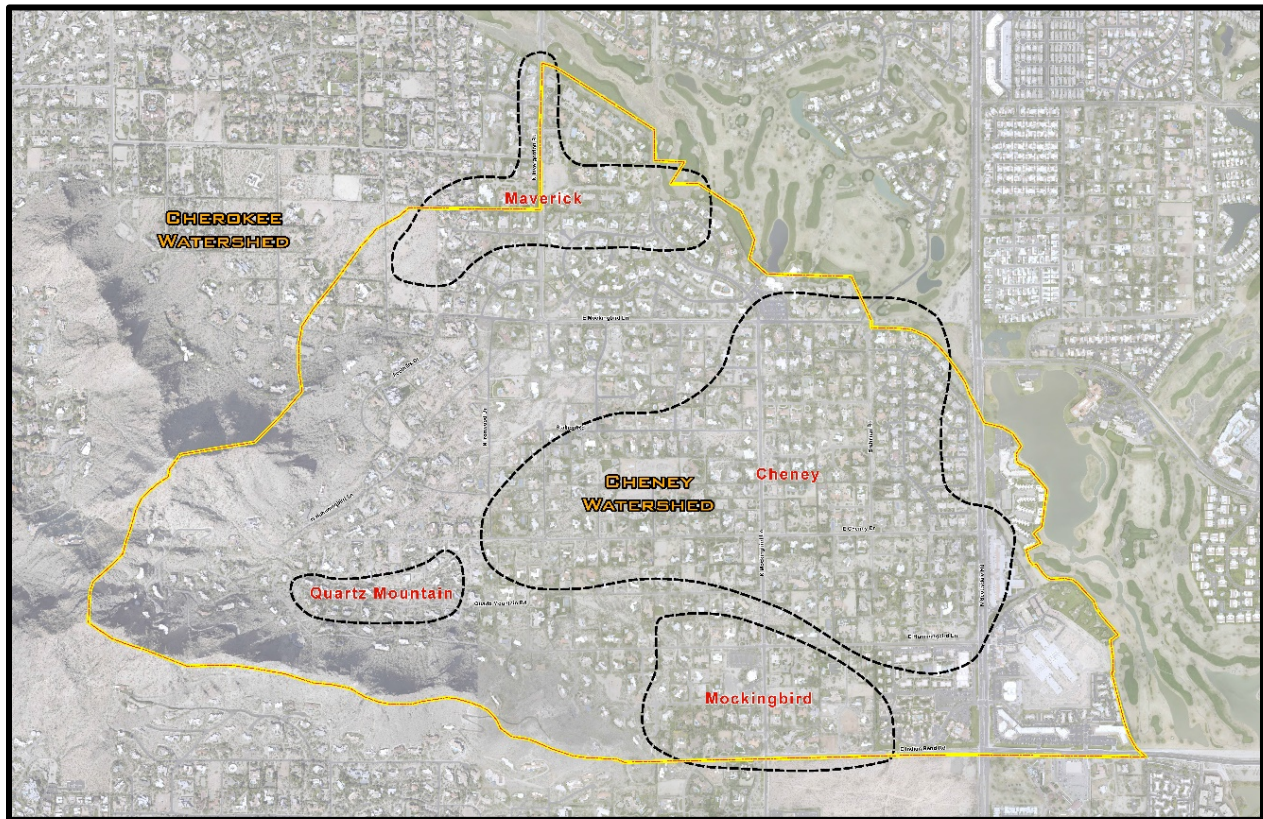

Figure 4 – Cheney Watershed – Improvement Areas Key Map

2. Facility Sizing and Opinion of Probable Construction Costs

Facility sizing was accomplished by extracting surface flow values from existing condition FLO-2D modeling. This effort was complicated by the preliminary FCDMC-proposed facilities that had not yet been developed to a point where modeling had been performed. However, for the purpose of establishing a basis of design flow value for Town-proposed facilities, existing conditions flows (without FCDMC facilities) were taken from the FLO-2D model results.

Each Improvement Area has various component projects included in the model and each component is assumed to be designed to convey a specific design storm (without FCDMC facilities) which could be the 10, 25, 50 or 100-year peak discharge. The 10-year and 100-year design discharges were taken from the existing conditions models at specific locations where the project alternative is anticipated to be located.

For alternatives that specify a design flow between the 10- and 100-year design storms, a reduction ratio is applied to estimate a 25-year or 50-year peak discharge rates. Methodologies were used based on those developed by the Pima County Flood Control District, which calibrated reduction ratios by watershed land use type. The Pima County reduction factors of 80% of the 100-year peak flow was used to establish the 50-year design flow and a 60% reduction factor was used to establish the 25-year design flow.

No other modifications were made to the FCDMC's FLO-2D models in regards to surface elevations, Manning's n-values, reduction factors, loss parameters, rainfall or model run configurations. Watershed areas upstream of projects match the existing conditions.

Using the design flow rates extracted from FLO-2D, preliminary facility sizing was performed using spreadsheets for storm drain pipes, retention basins, channels, and bank protection. Culverts were sized using FHWA HY-8 computer software. Sizing of storm drain and channel facilities was done using normal depth calculations.

Opinion of Probable Construction Costs are prepared for each alternative based upon the unit and quantity of materials necessary to construct, an evaluation of cost to relocate utilities in conflict with the alternative, and land acquisition. These assessments include such things as linear feet of storm drain pipe with associated manholes and catch basins, cubic yard of cut/fill material for the construction of storage basins, surface replacement costs, landscape, construction mobilization, miscellaneous removals, and traffic control. To consider the cost of land acquisition in the form of drainage easements or new rights-of-way, a value of \$26 per square foot was used in the opinion of probable cost calculations.

3. Preliminary Modeling of Alternatives

a. Methodology

Three new FLO-2D models were each prepared for the 10-year and 100-year recurrence intervals (six total) to estimate the downstream flood reduction benefits resulting from the proposed improvements within each hazard area. The FCDMC proposed improvements were assumed to be constructed for the 10-year design flow rates (regardless of Town alternative recurrence interval) and were included in each alternative for this analysis.

FLO-2D (2-dimensional) modeling was used as the means for estimating flood inundation limits, flow rates, flow velocities, etc. This method of modeling was performed because the FCDMC's Lower Indian Bend Wash ADMS/P used FLO-2D for the same purposes. By using the FCDMC's model and modifying it, these efforts were to be completed in a much more cost effective manner than if the Town had not used it. It also helped ensure that the Town's and FCDMC's master planning efforts were better coordinated. If the Town chooses to, the FLO-2D models can be made available to drainage design professionals for their use in modeling the effects of new development. The results of FLO-2D modeling is also accepted by FEMA.

Each alternative model originated from the Existing Conditions 100-year model and was modified to include the various project components and their unique design discharge. Flows were removed from the surface in the model using a FLO-2D modeling tool called a "hydraulic structure".

A hydraulic structure, such as a storm drain, typically accepts water based on the hydraulic constraints associated with the structure size, headwater, slope, length, tailwater condition, etc. Since we do not yet have detailed information about each proposed structure, we utilized a structure rating curve to remove a specified peak flow rate from the surface at a low headwater depth. A hydraulic structure uses a single inlet node or grid cell and a single discharge node. In order to collect an approaching flow that was spread over multiple grid cells, a levee routine was used to artificially funnel the flow to the inlet node. The levee elevation was set to be 6-inches above the existing 10-year flow depth. The hydraulic structures remove

flows from the surface up to the specified flow rate. When this rate was exceeded, it overtopped the artificial levee and continued downstream without causing a substantial rise in the water surface elevation at the inlet node. Stormwater that leaves the surface into the hydraulic structure was then retrieved at a specified grid based on the storm drain or channel outfall location.

The resultant model produces lower flow depths downstream and potentially reduces the level of flooding to buildings, properties and streets downstream.

b. Assumptions

In order to evaluate a conceptual drainage impact by multiple projects within a limited number of model runs, a few modeling assumptions were made. The design discharge for each alternative structure was taken from the 10-year or 100-year existing conditions FLO-2D model using floodplain cross sections. The chosen design discharge assumed that the design inflow rate was not impacted by an upstream project.

There are various FCDMC-proposed projects within the Cheney watershed. Dibble assumed that all FCDMC projects would be designed for the 10-year design flows which is consistent with information received from the FCDMC. Not all preliminary FCDMC-proposed alternatives were included in FLO-2D modeling as many had overlapping elements and components of competing alternatives. The FCDMC facilities assumed for using in modeling can be seen on the alternatives exhibits. After further development of the FCDMC-proposed alternatives by that agency, modification of this analysis may be necessary.

Not all projects identified within a hazard area were included in the FLO-2D model. This may be based on their design flow rate or their short improvement length from inlet to outlet. The FLO-2D results and flood reduction estimation are intended for planning purposes only. They are intended only for comparison between the alternatives presented herein, and are not appropriate for final design of drainage improvement elements.

The projects proposed in this analysis were selected so that they may be constructed independently of the FCDMC project. For the purpose of modeling and ranking the alternatives, the ability of each alternative to stand alone or to augment to benefits of FCDMC projects were considered.

c. Modeling Results

Modeling results are represented on several figures that are unique to each alternative. The figures provided in **Section V** display the conceptual facility sizing for each alternative as well as the 100-year storm event depth reduction resulting from the modeling of the alternative. The depth reduction for the 10-year storm event for each alternative is provided in **Appendix E**. **Appendix C** and **Appendix D** provide the residual stormwater inundation depths resulting from modeling with the alternatives in place for the 100-year and 10-year storms respectively.

V. Drainage Improvement Alternatives

A. Cheney Improvement Area – Alternative: Cheney 1

1. Description

Figure 5 displays the elements associated with Cheney 1.

Figure 5 Keynotes:

1. Underground storm drain from Cheney Drive to Mockingbird Lane – 2-year design storm
2. Bubble-up catch basins along Stallion Drive
3. Sediment capture basin designed for annual sediment load
4. Low Impact Development improvements within considerable open frontage area
5. Early construction of FCDMC 10-year storm drain system outlet to benefit adjacent properties
6. Underground storm drain in Brahman Road – 100-year design storm
7. Underground storm drain from 70th Street to existing culvert at Scottsdale Road – 100-year design storm

The 66th Street storm drain (Keynote 1) is expected to capture up to the 2-year design storm reaching the system at 66th Street and Cheney Drive, benefiting the structures and property east of the proposed alignment. The storm drain alignment passes through public rights-of-way and privately owned parcels; this alignment was chosen as least impactful to private property. The Cheney Drive storm drain alignment is intended to be located alongside the roadway pavement and not beneath it. The storm drain releases back to Mockingbird Lane at Stallion Drive via a series of bubble-up catch basins. For this reason, the design is limited to the 2-year storm event, or approximately 100 cfs. The FCDMC plans for a 10-year storm drain collection system in Cheney Drive will compliment this system; the combined system is expected to capture a 25-year design storm discharge, benefitting the area east of the 66th Street up to the location of the Stallion Road surface release. North and east of this location will be benefitted only by the FCDMC collection system.

Keynote Item 5 constructs the FCDMC planned 10-year storm drain mainline and interim catch basin collection system. This mainline could then be extended in the event of the FCDMC system implementation.

Keynote Items 6, 7 provide localized benefit to structures immediately adjacent to the elements. A 100-year design storm has been selected due to the relatively low contributing area and subsequent constructability of the facility sizes.

100-YR Depth Reduction	
Depth Ranges	No. of Buildings
0.101 - 0.5	6
0.501 - 1.0	31
1.001 - 1.5	6
1.501 - 2.0+	2
Total	45

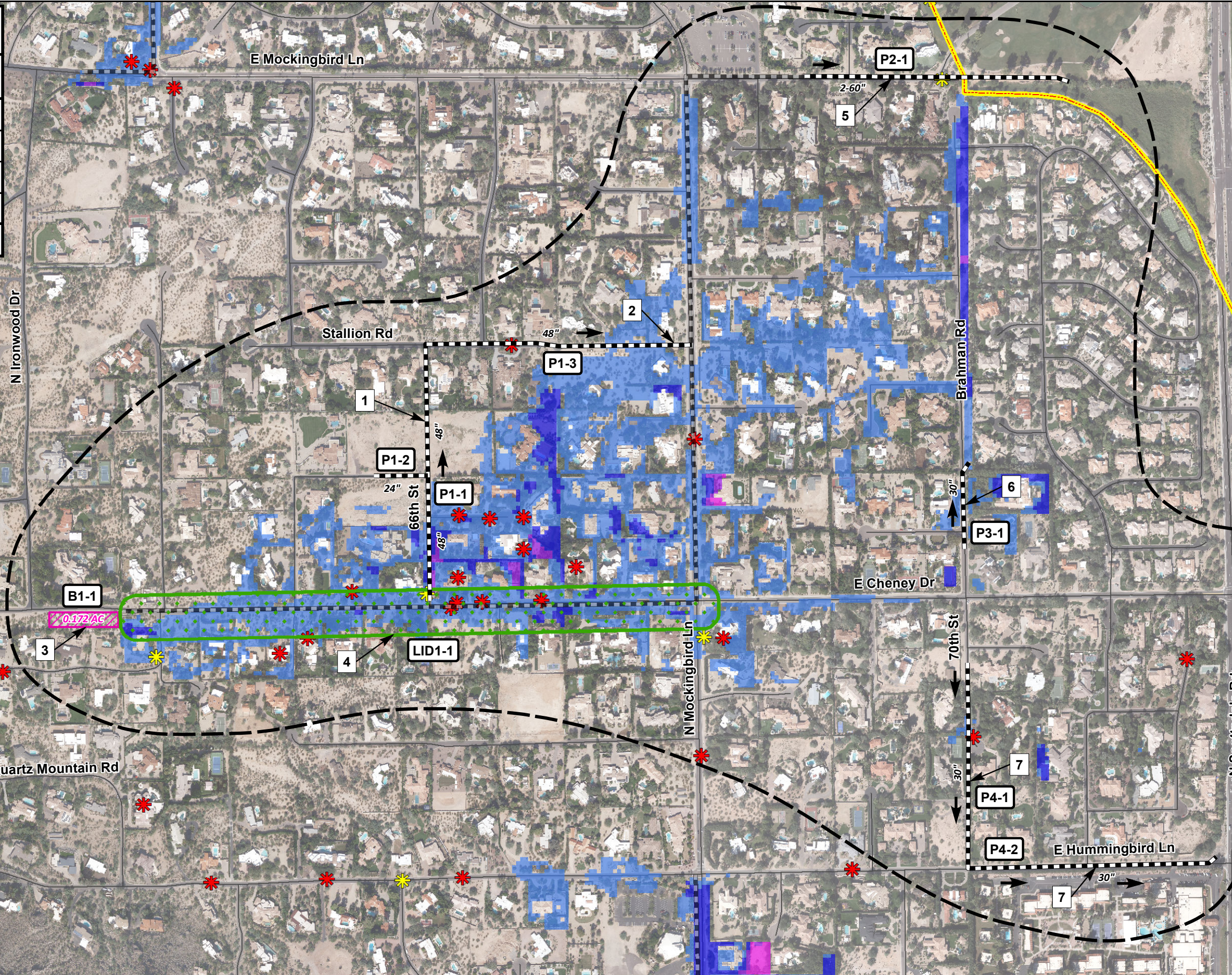

Legend

- Cheney Watershed Boundary
- Improvement Area
- Identified Flooding Problem Areas (Public Provided)
- Maintenance Problem Areas (Town Provided)
- Low Impact Development (LID)
- Sedimentation Basin
- Storm Mains
- Storm Mains - Preliminary (FCDMC)
- Flow Direction
- Alternative Element ID

100-Yr Flow Depth Reduction (Ft)

- <1 inch (Not Displayed)
- 0.101 - 0.5
- 0.501 - 1.0
- 1.001 - 1.5
- 1.501 - 2.0+



Figure 5

**Cheney Improvement Area
Alternative: Cheney 1**

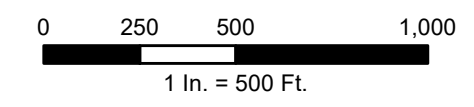

2. Performance

a. Stormwater Management Effectiveness

Preliminary FLO-2D modeling for the 10-year storm event supports that 20 homes would be completely removed from flood hazard. For the 100-year storm event, the result is that 18 homes would be completely removed from flood hazard. Note that less homes are protected from flooding during the larger (100-year) event due to the increased severity of the event. For the remaining floodprone buildings in the Improvement Area the anticipated reduction in flow depth at the structure for the 10-year and 100-year storm events are as shown in **Table 1**. These results include the benefit of the currently planned FCDMC facilities. There are no critical safety facilities within the improvement area; however, results support access to emergency vehicles would be improved by reducing the length of roadway experiencing significant flood depths as shown in **Table 2**. Finally, the reduction in the number of parcels experiencing flood depths exceeding 6-inches would be 59 and 25 for the 10-year and 100-year storm events respectively. LID facilities are proposed along Cheney Drive. While these facilities are likely to provide context sensitive mitigation of stormwater related damage, they are not expected to result in a measurable reduction in surface flow for the magnitude of storm events considered here. The elements associated with this alternative are passive in nature; no manual or mechanical intervention during storm events is needed for them to function.

Table 1 – Cheney 1 Flow Depth Reduction of Remaining Floodprone Buildings

Flow Depth Reduction Ranges	10-Year No. of Buildings	100-Year No. of Buildings
0.101 - 0.5	*	6
0.501 - 1.0	*	31
1.001 - 1.5	*	6
1.501 - 2.0+	*	2
Total	*	45

* For Cheney 1 – no buildings remain inundated for the 10-year storm event

Table 2 – Cheney 1 Street Flooding Reduction

10-Year Street Flooding Reduction			100-Year Street Flooding Reduction		
Exst Length (Miles)	Proposed Length (Miles)	Reduction Length (Miles)	Exst Length (Miles)	Proposed Length (Miles)	Reduction Length (Miles)
0.72	0.31	0.41	1.17	0.78	0.39

b. Cost

The estimated cost for Alternative Cheney 1 is \$3,943,000. A cost summary with a breakdown according to element type is provided in **Appendix G**. The elements included in the cost estimation are discussed in **Section IV.C.2**.

Long-term maintenance of the system would include regular monitoring and maintenance of the underground storm drain for clogging and siltation, particularly at the bubble-up catch basins on Stallion Road, sediment removal from the sedimentation basin provided on Cheney Drive, and erosion control maintenance of the storm drain outlets at Mockingbird Lane, Brahman Road, and Hummingbird Lane. Long-term maintenance is considered to be low as compared to the other alternatives in this improvement area.

c. Public Acceptance

Interaction directly with the public in two public meetings and the results of survey polling suggest that this alternative is generally in conformance with public preferences with only isolated exceptions. The elements are contextually sensitive and maintain the existing aesthetic value – the storm drain and collection system would be largely unseen on the surface. Similarly, post-construction disruption to the existing use of private property and to traffic within public rights-of-way would be minimal, because the facilities are largely beneath existing roadways. Exceptions exist at the proposed sedimentation basin along Cheney Drive and the approximately 600 feet of storm drain passing through private parcels along the 66th Street alignment. This elements would likely require a drainage easement and would limit some use of the property within the easement. Construction is limited to local streets, causing less disruption to the public during construction. This alternative does not provide any multiuse opportunities.

d. Constructability/Construction Phasing

This alternative is well suited to flexible implementation. Each storm drain component and the sedimentation basin may be implemented separately, providing stormwater protection benefit independently of one another. The elements of this alternative may be implemented independently of the FCDMC-proposed facilities currently being planned in this area. FCDMC elements may be implemented before or after the elements of this alternative; each providing benefit independently, and the combined benefit to be realized once both are in place. There are no unusual or non-standard construction elements that might make construction unusually difficult. Eighty-nine (89) potential utility conflicts have been identified for this alternative. Precise vertical and horizontal locating during future phases will determine the precise nature of the crossings and if they can be avoided. A summary of potential utility conflicts is provided in **Appendix F**.

3. *Advantages and Disadvantages*

Advantages:

- Least costly
- Very context sensitive
- Limits disruption to low traffic areas
- Serves most critical area
- Provides benefit independently of and in-tandem with FCDMC-planned facilities

Disadvantages:

- Least breadth of benefit area
- Local street alignments limit system sizing
- Release to Mockingbird Lane limits system sizing
- Underground facilities are more difficult to maintain

B. Cheney Improvement Area – Alternative: Cheney 2

1. Description

Figure 6 displays the elements associated with Cheney 2.

Figure 6 Keynotes:

1. Underground storm drain from Cheney Drive to Mockingbird Lane – 10-year design storm
2. Underground storm drain from Stallion Road to Indian Bend Wash – 50-year design storm
3. Sediment capture basin designed for annual sediment load
4. Low Impact Development improvements within considerable open frontage area
5. Underground storm drain in Brahman Road – 100-year design storm
6. Underground storm drain from 70th Street to existing culvert at Scottsdale Road – 100-year design storm

The 66th Street storm drain (Keynote 1) is expected to capture up to the 10-year design storm reaching the system at 66th Street and Cheney Drive, benefiting the structures and property east of the proposed alignment. The storm drain alignment passes through public rights-of-way and privately owned parcels; this alignment was chosen as least impactful to private property. The Cheney Drive storm drain alignment is intended to be located alongside the roadway pavement and not beneath it. The storm drain connects to the Mockingbird Lane trunk line. Due to tight residential corridors, a 10-year design storm is expected to be the maximum practical design storm for this system. The FCDMC plans for a 10-year storm drain collection system in Cheney Drive will compliment this system; the combined system is expected to capture a 50-year design storm discharge from Cheney Wash, benefitting the area east of the 66th Street. The Mockingbird Lane storm drain (Keynote 2) is an upsizing of the FCDMC-proposed facility to accommodate inflow from both this alternative and the FCDMC-proposed system. The result is conveyance of inflows from Cheney Wash approximately meeting the 50-year peak flow, and benefiting nearly all areas in the Cheney Improvement Area.

Keynote Items 5 and 6 provide localized benefit to structures immediately adjacent to the elements. A 100-year design storm has been selected due to the relatively low contributing area and subsequent constructability of the facility sizes.

2. Performance

a. Stormwater Management Effectiveness

Preliminary FLO-2D modeling for the 10-year storm event supports that 20 homes would be completely removed from flood hazard. For the 100-year storm event, the result is that 20 homes would be completely removed from flood hazard. For the remaining floodprone buildings in the Improvement Area the anticipated reduction in flow depth at the structure for the 10-year and 100-year storm events are as

shown in **Table 3**. These results include the benefit of the currently planned FCDMC facilities. There are no critical safety facilities within the improvement area; however, results support access to emergency vehicles would be improved by reducing the length of roadway experiencing significant flood depths as shown in **Table 4**. Finally, the reduction in the number of parcels experiencing flood depths exceeding 6-inches would be 60 and 29 for the 10-year and 100-year storm events respectively. LID facilities are proposed along Cheney Drive. While these facilities are likely to provide contextually sensitive mitigation of stormwater related damage, they are not expected to result in a measurable reduction in surface flow for the magnitude of storm events considered here. The elements associated with this alternative are passive in nature; no manual or mechanical intervention during storm events is needed for them to function.

Table 3 – Cheney 2 Flow Depth Reduction of Remaining Floodprone Buildings

Flow Depth Reduction Ranges (ft)	10-Year No. of Buildings	100-Year No. of Buildings
0.101 - 0.5	*	3
0.501 - 1.0	*	31
1.01 - 1.5	*	7
1.501 - 2.0+	*	2
Total	*	43

* For Cheney 2 – no buildings remain inundated for the 10-year storm event

Table 4 – Cheney 2 Street Flooding Reduction

10-Year Street Flooding Reduction			100-Year Street Flooding Reduction		
Exst Length (Miles)	Proposed Length (Miles)	Reduction Length (Miles)	Exst Length (Miles)	Proposed Length (Miles)	Reduction Length (Miles)
0.72	0.22	0.50	1.17	0.46	0.71

a. Cost

The estimated cost for Alternative Cheney 2 is \$4,729,000. A cost summary with a breakdown according to element type is provided in **Appendix G**. The elements included in the cost estimation are discussed in **Section IV.C.2**.

Long-term maintenance of the system would include regular monitoring and maintenance of the underground storm drain for clogging and siltation, sediment removal from the sedimentation basin provided on Cheney Drive, and erosion control maintenance of the storm drain outlets at Mockingbird Lane, Brahman Road, and Hummingbird Lane. Due to the length of underground facilities, long-term maintenance is considered to be high as compared to the other alternatives in this improvement area.

100-YR Depth Reduction	
Depth Ranges	No. of Buildings
0.101 - 0.5	3
0.501 - 1.0	31
1.001 - 1.5	7
1.501 - 2.0+	2
Total	43

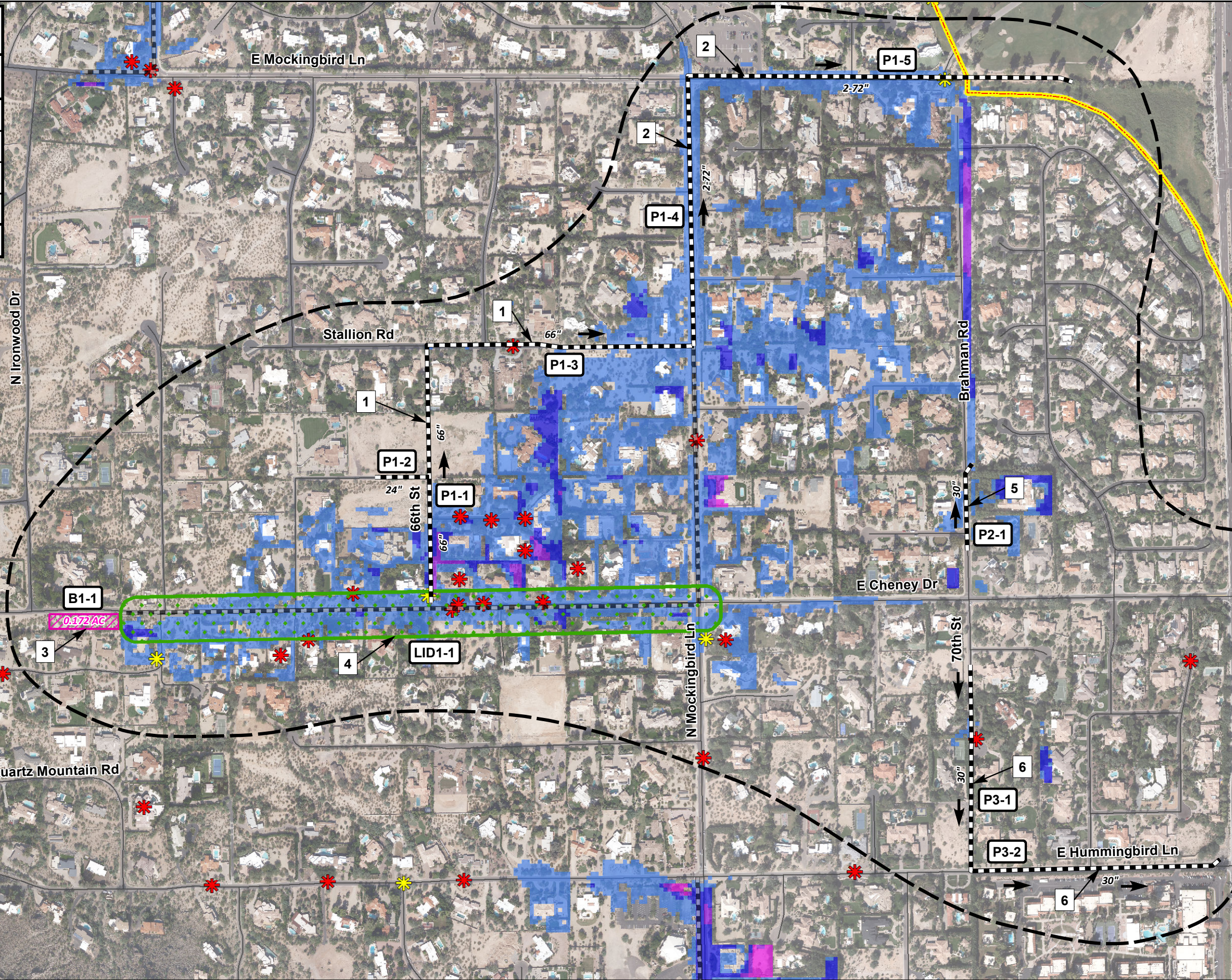

Legend

- Cheney Watershed Boundary
- Improvement Area
- Identified Flooding Problem Areas (Public Provided)
- Maintenance Problem Areas (Town Provided)
- Low Impact Development (LID)
- Sedimentation Basin
- Storm Mains
- Storm Mains - Preliminary (FCDMC)
- Flow Direction
- P1-1 Alternative Element ID

100-Yr Flow Depth Reduction (Ft)

- <1 inch (Not Displayed)
- 0.101 - 0.5
- 0.501 - 1.0
- 1.001 - 1.5
- 1.501 - 2.0+

b. Public Acceptance

Interaction directly with the public in two public meetings and the results of survey polling suggest that this alternative is generally in conformance with public preferences with only isolated exceptions. The elements are contextually sensitive and maintain the existing aesthetic value – the storm drain and collection system would be largely unseen on the surface. Similarly, post-construction disruption to the existing use of private property and to traffic within public rights-of-way would be minimal, because the facilities are largely beneath existing roadways. Exceptions exist at the proposed sedimentation basin along Cheney Drive and the approximately 600 feet of storm drain passing through private parcels along the 66th Street alignment. These elements would likely require a drainage easement and would limit some use of the property within the easement. The construction of element P1-4 within Mockingbird Lane could be a significant disruption to residents, as this length of collector roadway is the primary north-south corridor within the Cheney Study Area. This alternative does not provide any multi-use opportunities.

c. Constructability/Construction Phasing

This alternative is moderately well suited to flexible implementation. Each storm drain component and the sedimentation basin may be implemented separately, providing stormwater protection benefit independently of one another. The elements of this alternative may be implemented independently of the FCDMC facilities currently being planned in this area; however, because elements P1-4 and P1-5 represent an upsizing of these facilities, any FCDMC component of funding would be dependent on the FCDMC prioritization schedule. If FCDMC elements are constructed prior to implementation of this alternative, and without incorporating the associated upsizing of elements P1-4 and P1-5, this alternative would require an additional outfall beginning at Stallion Road and would lose the cost benefit of concurrent construction and integration of facilities. There are no unusual or non-standard construction elements that might make construction unusually difficult. One-hundred and thirteen (113) potential utility conflicts have been identified for this alternative. Precise vertical and horizontal locating during future phases will determine the precise nature of the crossings and if they can be avoided. A summary of potential utility conflicts is provided in **Appendix F**.

3. Advantages and Disadvantages

Advantages:

- Very contextually sensitive
- Serves both most critical area and secondary areas
- Provides benefit independently of and in tandem with FCDMC-planned facilities

Disadvantages:

- Not least costly
- Requires a large system in Mockingbird Lane
- Potential for significant traffic disruption of primary north-south collector
- Dependent on FCDMC prioritization schedule for cost sharing of elements P1-4 and P1-5
- Available right-of-way limits some system sizing
- Underground facilities are more difficult to maintain

C. Cheney Improvement Area – Alternative: Cheney 3

1. Description

Figure 7 displays the elements associated with Cheney 3.

Figure 7 Keynotes:

1. Open channel on south side of Cheney Drive; crosses Mockingbird Lane and Scottsdale Road; See Figures 6 and 7 for conceptual channel section.
2. Sediment capture basin designed for annual sediment load
3. Early construction of FCDMC 10-year storm drain system outlet to benefit adjacent properties
4. Underground storm drain in Brahman Road – 100-year design storm
5. Underground storm drain from 70th Street to existing culvert at Scottsdale Road – 100-year design storm

Planning-level analyses of a new channel on the south side of Cheney drive suggests a potential capacity of approximately 215-cfs without extensive modification to existing right-of-way limits. This flow rate represents between a 5-year and 10-year peak flow for Cheney Wash. The channel requires shifting Cheney Drive to the northern edge of the existing right-of-way for a length of approximately 2,000-feet; beginning just west of Invergordon Road.

New easements are required in segments both west and east of Mockingbird Lane. At least 3 land owners will require roughly 30 feet to 35 feet wide easements; and at least 7 land owners will require 10 feet to 15 feet wide easements. East of 70th Street, sidewalk is required to be relocated to the north side of Cheney Drive; this matches the existing treatment between Mockingbird Lane and 70th Street. **Figure 8** and **Figure 9** provide conceptual sections and approximate sizing of the channel elements.

This alternative requires a capacity analysis of the existing outfall channel east of Scottsdale Road; however, FLO-2D modeling supports that the channel would not be overtopped during the 100-year storm event with the additional inflow. The FCDMC plan for a 10-year storm drain collection system in Cheney Drive will compliment this system; the combined system is expected to capture a 50-year design storm discharge from Cheney Wash, benefitting nearly all areas in the Cheney Improvement Area. The channel could be designed such that low flows remain within the channel, only entering the parallel storm drains systems during large, infrequent events. This will help to reduce storm drain maintenance requirements.

Keynote Item 3 constructs the FCDMC planned 10-year storm drain mainline and interim catch basin collection system. This mainline could then be extended in the event of the FCDMC system implementation.

Keynote Items 5 and 6 provide localized benefit to structures immediately adjacent to the elements. A 100-year design storm has been selected due to the relatively low contributing area and subsequent constructability of the facility sizes.

100-YR Depth Reduction	
Depth Ranges	No. of Buildings
0.101 - 0.5	7
0.501 - 1.0	27
1.001 - 1.5	5
1.501 - 2.0+	1
Total	40

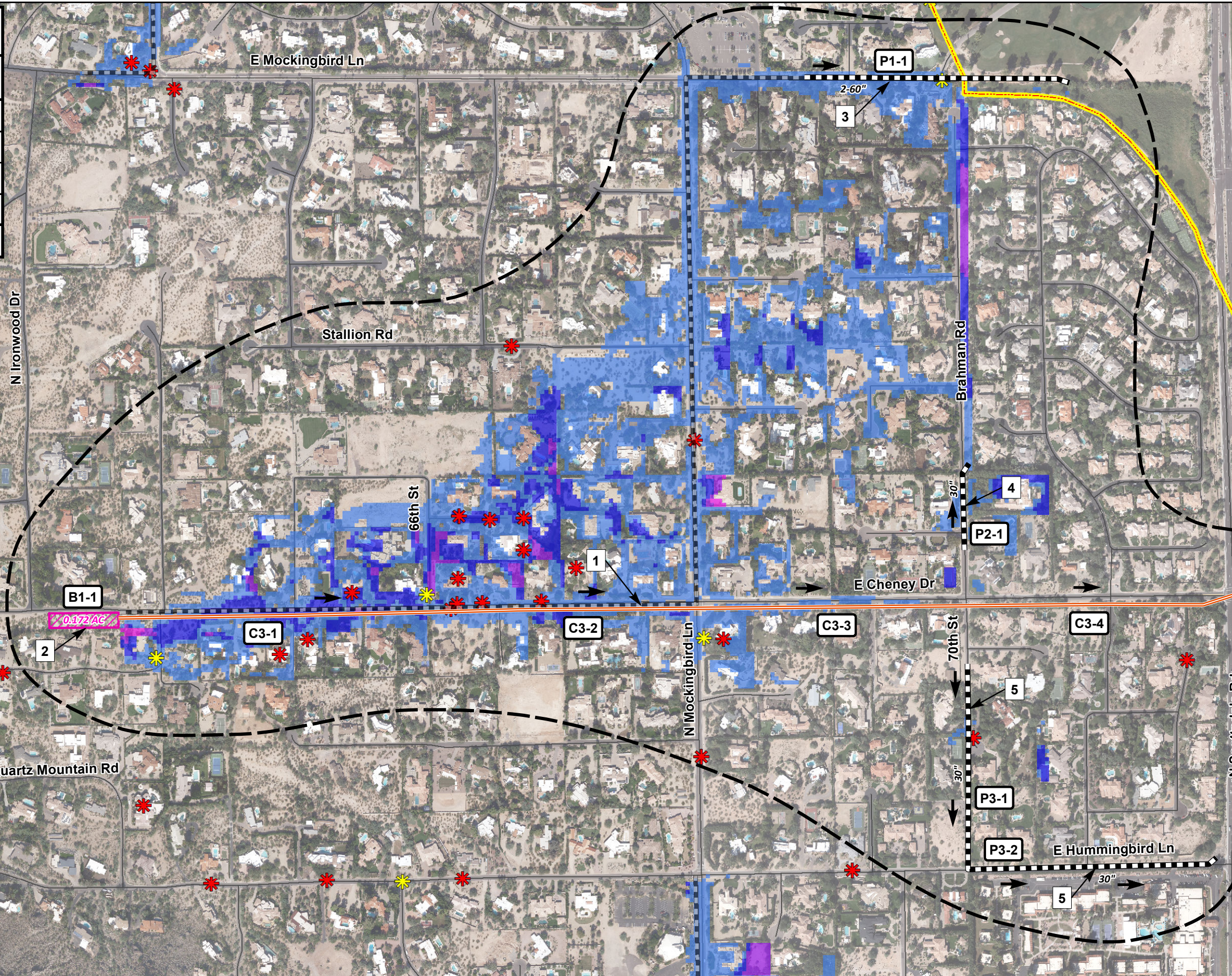

Legend

- Cheney Watershed Boundary
- Improvement Area
- Identified Flooding Problem Areas (Public Provided)
- Maintenance Problem Areas (Town Provided)
- Sedimentation Basin
- Improved Channels
- Storm Mains
- Storm Mains - Preliminary (FCDMC)
- Flow Direction
- Alternative Element ID

100-Yr Flow Depth Reduction (Ft)

- <1 inch (Not Displayed)
- 0.101 - 0.5
- 0.501 - 1.0
- 1.001 - 1.5
- 1.501 - 2.0+



Figure 7

**Cheney Improvement Area
Alternative: Cheney 3**

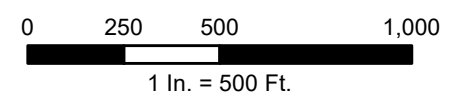

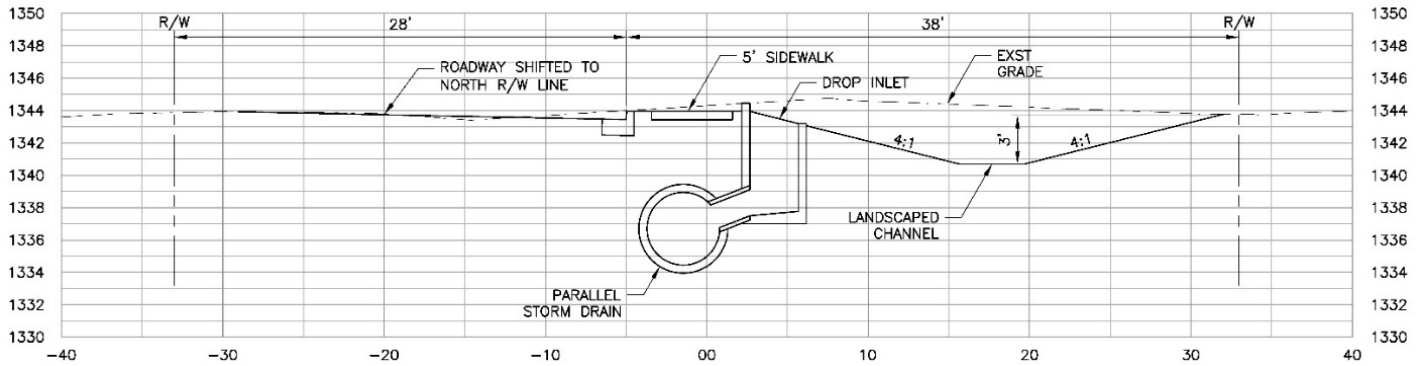

Figure 8 – Cheney Channel Typical Section with Storm Drain Overflow Inlet (Facing East)

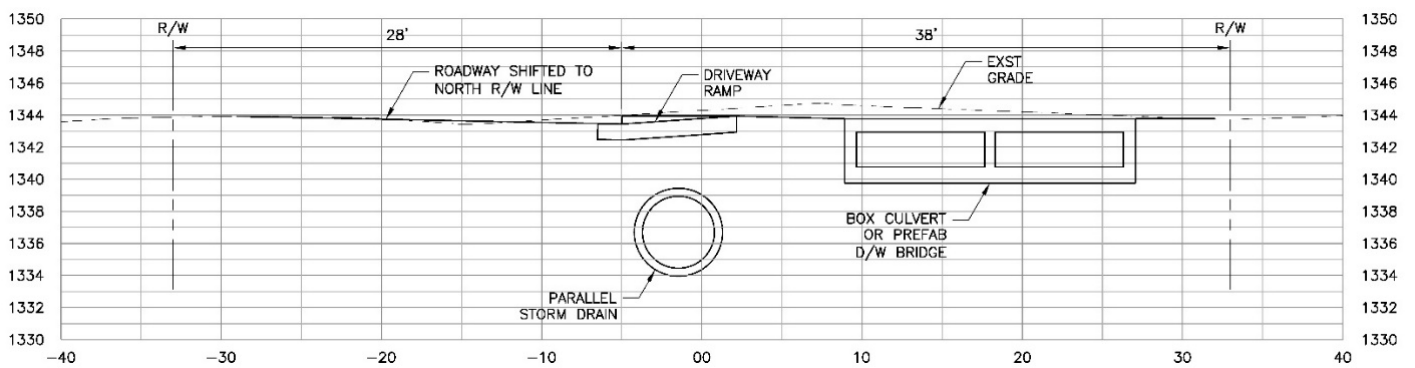

Figure 9 – Cheney Channel Typical Driveway Culvert (Facing East)

2. Performance

a. Stormwater Management Effectiveness

Preliminary FLO-2D modeling for the 10-year storm event supports that 20 homes would be completely removed from flood hazard. For the 100-year storm event, the result is that 23 homes would be completely removed from flood hazard. For the remaining floodprone buildings in the Improvement Area the anticipated reduction in flow depth at the structure for the 10-year and 100-year storm events are as shown in **Table 5**. These results include the benefit of the currently planned FCDMC facilities. There are no critical safety facilities within the improvement area; however, results support access to emergency vehicles would be improved by reducing the length of roadway experiencing significant flood depths as shown in **Table 6**.

Finally, the reduction in the number of parcels experiencing flood depths exceeding 6-inches would be 59 and 30 for the 10-year and 100-year storm events respectively. There are no LID facilities as part of this alternative. The elements associated with this alternative are passive in nature; no manual or mechanical intervention during storm events is needed for them to function.

Table 5 – Cheney 3 Flow Depth Reduction of Remaining Floodprone Buildings

Flow Depth Reduction Ranges (ft)	10-Year No. of Buildings	100-Year No. of Buildings
0.101 - 0.5	*	7
0.501 - 1.0	*	27
1.01 - 1.5	*	5
1.501 - 2.0+	*	1
Total	*	40

* For Cheney 3 – no buildings remain inundated for the 10-year storm event

Table 6 – Cheney 3 Street Flooding Reduction

10-Year Street Flooding Reduction			100-Year Street Flooding Reduction		
Exst Length (Miles)	Proposed Length (Miles)	Reduction Length (Miles)	Exst Length (Miles)	Proposed Length (Miles)	Reduction Length (Miles)
0.72	0.25	0.47	1.17	0.42	0.75

b. Cost

The estimated cost for Alternative Cheney 3 is \$6,555,000. A cost summary with a breakdown according to element type is provided in **Appendix G**. The elements included in the cost estimation are discussed in **Section IV.C.2**. It should be noted that the cost of shifting Cheney Drive to the north side of the existing right-of-way for a length of 2,000 feet as described previously is not included in the estimated cost; this is due to the inclusion of roadway improvements to Cheney Drive in the FCDMC-proposed preliminary alternatives.

Long-term maintenance of the system would include maintenance of the channel landscape treatment as well as monitoring and mitigation of erosion and sedimentation within the channel. Regular sediment removal would be required from the sedimentation basin provided on Cheney Drive, and erosion control maintenance of the storm drain outlets at Brahman Road and Hummingbird Lane would be necessary. Due to the length of open channel with landscape elements, the long-term maintenance is considered to be high as compared to the other alternatives in this improvement area.

c. Public Acceptance

Interaction directly with the public in two public meetings and the results of survey polling suggest that this alternative is generally in conformance with public preferences in some but not all respects. The elements are largely contextually sensitive and maintain the existing aesthetic value. Channel elements would be constructed with natural linings, matching the desert plant life and rock types that are characteristic of the area. However, culverts with headwalls would be required at all driveway locations;

this could be viewed as less than desirable by residents. New drainage easements to construct and maintain the channel are likely to be less than desirable to those directly impacted on the south side of Cheney Drive.

d. Constructability/Construction Phasing

This alternative is moderately well suited to flexible implementation. Each storm drain component, channel, and the sedimentation basin may be implemented separately, providing stormwater protection benefit independently of one another. The elements of this alternative may be implemented independently of the FCDMC-proposed facilities currently being planned in this area; however, the channel construction requires realignment of Cheney Drive for a length of approximately 2,000 feet, currently not included in the project cost because it is also component of the FCDMC-proposed preliminary alternative. Any FCDMC component of funding for this would be dependent on the FCDMC prioritization schedule. If FCDMC-proposed elements are constructed prior to implementation of this alternative, and done without incorporating the associated street realignment, this alternative would require additional right-of-way acquisition for construction of the Channel component. There are no unusual or non-standard construction elements that might make construction unusually difficult. One-hundred and thirty-one (131) potential utility conflicts have been identified for this alternative. Precise vertical and horizontal locating during future phases will determine the precise nature of the crossings and if they can be avoided. Of particular importance is the existence of an APS 69kv electric transmission line within Scottsdale Road. A summary of potential utility conflicts is provided in **Appendix F**.

3. Advantages and Disadvantages

Advantages:

- Largest breadth of benefit area-nearly all areas in Cheney Improvement Area
- Provides opportunity for pedestrian corridor
- Provides benefit independently of and in tandem with FCDMC-planned facilities

Disadvantages:

- Most costly
- Requires difficult crossing of Scottsdale Road
- Requires new easements and modification to existing yards
- Highest level of long term maintenance
- Potential difficult utility crossing of APS 69kv electric transmission line in Scottsdale Road

D. Mockingbird Improvement Area – Alternative: Mockingbird 1

1. Description

Figure 10 displays the elements associated with Mockingbird 1.

Figure 10 Keynotes:

1. Underground storm drain in Hummingbird Lane – 10-year design storm
2. Sediment capture basin designed for annual sediment load
3. Stormwater retention on church property – 10-year design storm volume

Mockingbird 1 collects and retains the 10-year design storm from the incoming wash at Hummingbird Lane, providing protection to downstream properties along Mockingbird Lane and Indian Bend Road. The FCDMC plans for a 10-year storm drain collection system in Mockingbird Lane will compliment this system. The system has been analyzed and the basin sized as an online basin, not physically connected to the FCDMC-proposed system. As such, the combined capture capacity (including the FCDMC 10-year capacity) is approximately a 50-year flow rate from the incoming wash. However, if incorporated as an off-line basin in coordination with the FCDMC-proposed system, the system could potentially provide further increased capacity with the same storage volume. Due to the uncertainty of the FCDMC alternative development to date, this variation on the design is not incorporated here. For clarification, online basins are those that route all stormwater flows through them as opposed to offline basins which allow high stormwater flows to spill into them.

A discussion has taken place with a church representative. At this time the organization is open to further discussion of the possibility of the use of the property in this manner; it may be consistent with their long term plans for their organization. Assuming a maximum basin water depth of 3 feet and 1 foot of freeboard, the required volume for the 10-year design exceeds the available undeveloped space on the parcel. Therefore, cost estimating of the alternative has assumed that the required volume beyond the available surface capacity would be stored within a 96-inch diameter underground retention system and the parking lot reconstructed above.

2. Performance

a. Stormwater Management Effectiveness

Preliminary FLO-2D modeling for the 10-year storm event supports that 5 homes would be completely removed from flood hazard. For the 100-year storm event, the result is that 4 homes would be completely removed from flood hazard. For the remaining floodprone buildings in the Improvement Area the anticipated reduction in flow depth at the structure for the 10-year and 100-year storm events are as shown in **Table 7**. These results include the benefit of the currently planned FCDMC facilities. There are no critical safety facilities within the improvement area; however, results support access for emergency vehicles would be improved by reducing the length of roadway experiencing significant flood depths as shown in **Table 8**.

Finally, the reduction in the number of parcels experiencing flood depths exceeding 6-inches would be 18 and 14 for the 10-year and 100-year storm events respectively. There are no LID facilities as part of this

alternative. The elements associated with this alternative are passive in nature; no manual or mechanical intervention during storm events is needed for them to function.

100-YR Depth Reduction	
Depth Ranges	No. of Buildings
0.101 - 0.5	3
0.501 - 1.0	9
1.001 - 1.5	4
1.501 - 2.0+	5
Total	21

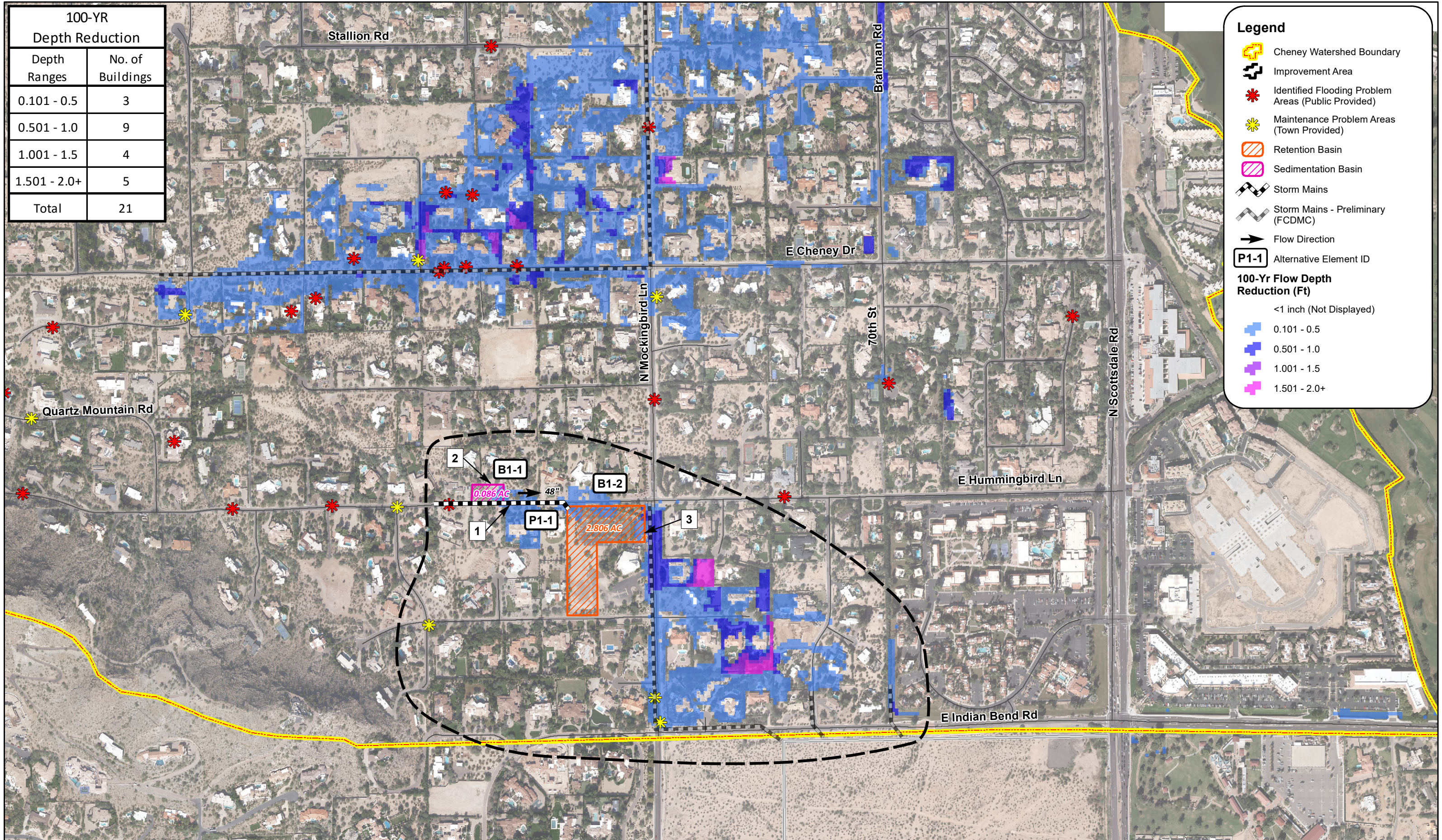

Legend

- Cheney Watershed Boundary
- Improvement Area
- Identified Flooding Problem Areas (Public Provided)
- Maintenance Problem Areas (Town Provided)
- Retention Basin
- Sedimentation Basin
- Storm Mains
- Storm Mains - Preliminary (FCDMC)
- Flow Direction
- P1-1 Alternative Element ID

100-Yr Flow Depth Reduction (Ft)

- <1 inch (Not Displayed)
- 0.101 - 0.5
- 0.501 - 1.0
- 1.001 - 1.5
- 1.501 - 2.0+

Table 7 – Mockingbird 1 Flow Depth Reduction of Remaining Floodprone Buildings

Flow Depth Reduction Ranges (ft)	10-Year No. of Buildings	100-Year No. of Buildings
0.101 - 0.5	0	3
0.501 - 1.0	1	9
1.01 - 1.5	1	4
1.501 - 2.0+	0	5
Total	2	21

Table 8 – Mockingbird 1 Street Flooding Reduction

10-Year Street Flooding Reduction			100-Year Street Flooding Reduction		
Exst Length (Miles)	Proposed Length (Miles)	Reduction Length (Miles)	Exst Length (Miles)	Proposed Length (Miles)	Reduction Length (Miles)
0.21	0.09	0.12	0.44	0.15	0.29

b. Cost

The estimated cost for Alternative Mockingbird 1 is \$4,870,000. A cost summary with a breakdown according to element type is provided in **Appendix G**. The elements included in the cost estimation are discussed in **Section IV.C.2**.

Long-term maintenance of the system would include maintenance of the retention basin landscape treatment, and regular sediment removal would be required from the sedimentation basin provided on Hummingbird Lane. Erosion control maintenance of the storm drain outlet at the retention basin and monitoring and sediment removal from the storm drain collection pipe would be necessary. Long-term maintenance is considered to be moderate as compared to the other alternatives in this improvement area.

c. Public Acceptance

Interaction directly with the public in two public meetings and the results of survey polling suggest that this alternative is generally in conformance with public preferences. The elements are contextually sensitive and maintain the existing aesthetic value, possibly improving the aesthetic value in the case of the landscaped surface retention basin. As mentioned previously, the existing land owner is open to further discussion of the possibility of the use of the property in this manner, and it may be consistent with their long term plans for their organization. A drainage easement would be required from one residential parcel as part of the construction of the sedimentation basin on Hummingbird Lane.

d. Constructability/Construction Phasing

This alternative has few components and would likely be constructed as a single project. The elements of this alternative may be implemented independently of the FCDMC-proposed facilities currently being planned in this area; however, the FCDMC-proposed storm drain within Mockingbird Lane would provide a means to drain the retention basins in lieu of dry wells and soil infiltration. There are no unusual or non-standard construction elements that might make construction unusually difficult. Seventeen (17) potential utility conflicts have been identified. Precise vertical and horizontal locating during future phases will determine if conflicts can be avoided. A summary of utility conflicts is provided in **Appendix F**. Construction of the alternative is dependent on reaching an agreement with the existing property owners.

3. Advantages and Disadvantages

Advantages:

- Takes advantage of existing undeveloped area
- Larger breadth of benefit area
- A potential amenity to the church
- Limits disruption to low traffic areas
- Provides benefit independently of and in tandem with FCDMC-planned facilities

Disadvantages:

- More costly
- Dependent on church's long term plans
- Requires new easements
- Underground storage facilities are more difficult to maintain

E. Mockingbird Improvement Area – Alternative: Mockingbird 2

1. Description

Figure 11 displays the elements associated with Mockingbird 2.

Figure 11 Keynotes:

1. Underground storm drain in Hummingbird Lane – 25-year design storm
2. Sediment capture basin designed for annual sediment load
3. Stormwater retention on church property – 25-year design storm volume

Mockingbird 2 collects and retains the 25-year design storm, providing protection to downstream properties along Mockingbird Lane and Indian Bend Road. The FCDMC plans for a 10-year storm drain collection system in Mockingbird Lane will compliment this system. The system has been analyzed and the basin sized as an online basin, not physically connected to the FCDMC-proposed system. As such, the combined capture capacity (including the FCDMC 10-year capacity) is approximately a 100-year flow from the incoming wash. However, if incorporated as an off-line basin in coordination with the FCDMC system, the system could potentially provide further increased capacity with the same storage volume. Due to the uncertainty of the FCDMC-proposed alternative development, this variation on the design is not incorporated here.

A discussion has taken place with a church representative. At this time the organization is open to further discussion of the possibility of the use of the property in this manner; it may be consistent with their long term plans for their organization. Assuming a maximum basin water depth of 3 feet and 1 foot of freeboard, the required volume for the 10-year design exceeds the available undeveloped space on the parcel. Therefore, cost estimating of the alternative has assumed that the required volume beyond the available surface capacity would be stored within a 96-inch diameter underground retention system and the parking lot reconstructed above.

2. Performance

a. Stormwater Management Effectiveness

Preliminary FLO-2D modeling for the 10-year storm event supports that 5 homes would be completely removed from flood hazard. For the 100-year storm event, the result is that 4 homes would be completely removed from flood hazard. For the remaining floodprone buildings in the Improvement Area the anticipated reduction in flow depth at the structure for the 10-year and 100-year storm events are as shown in **Table 9**. These results include the benefit of the currently planned FCDMC facilities. There are no critical safety facilities within the improvement area; however, results support access to emergency vehicles would be improved by reducing the length of roadway experiencing significant flood depths as shown in **Table 10**.

Finally, the reduction in the number of parcels experiencing flood depths exceeding 6-inches would be 18 and 15 for the 10-year and 100-year storm events respectively. There are no LID facilities as part of this alternative. The elements associated with this alternative are passive in nature; no manual or mechanical intervention during storm events is needed for them to function.

100-YR Depth Reduction	
Depth Ranges	No. of Buildings
0.101 - 0.5	3
0.501 - 1.0	9
1.001 - 1.5	4
1.501 - 2.0+	5
Total	21

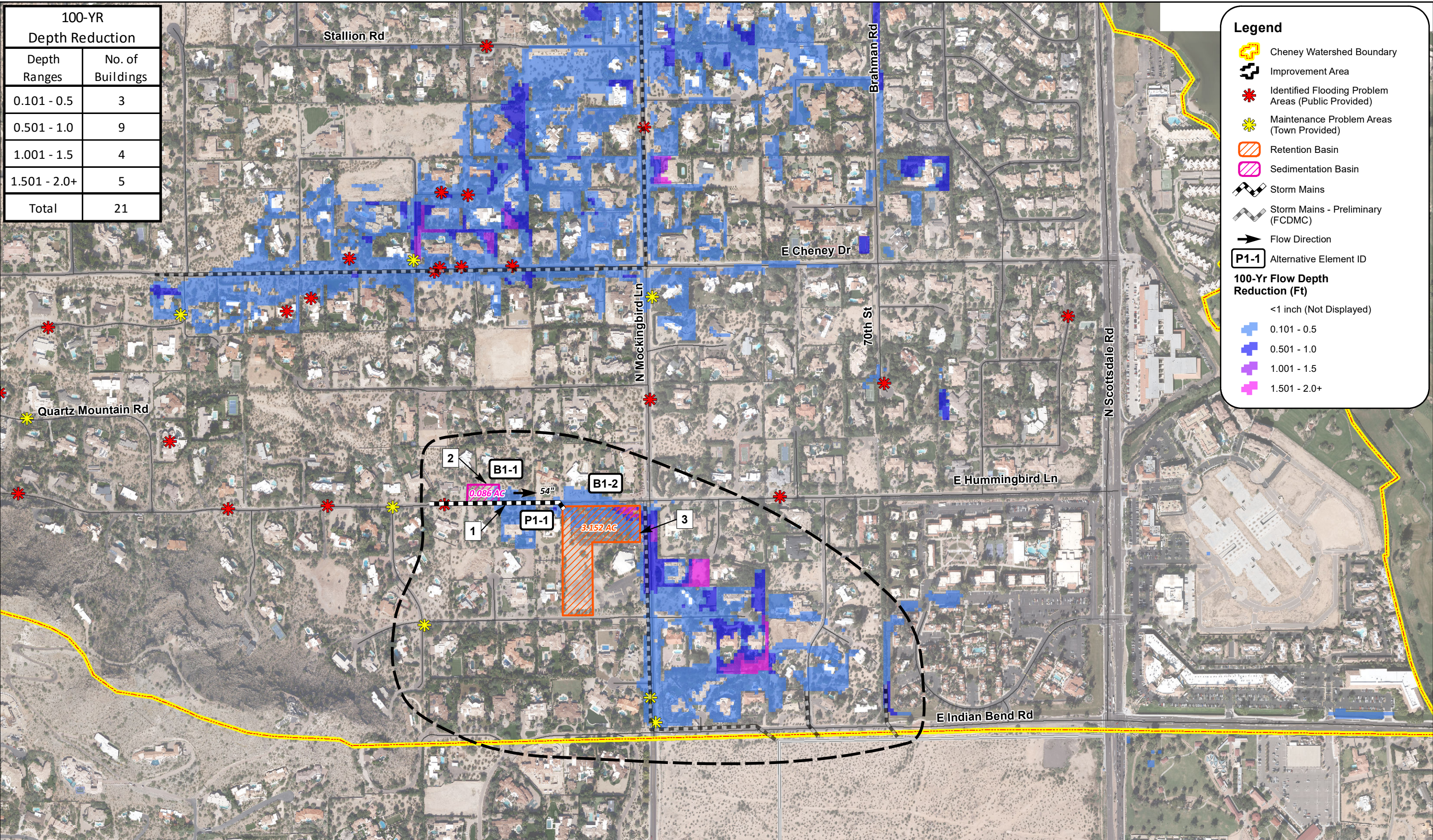

Legend

- Cheney Watershed Boundary
- Improvement Area
- Identified Flooding Problem Areas (Public Provided)
- Maintenance Problem Areas (Town Provided)
- Retention Basin
- Sedimentation Basin
- Storm Mains
- Storm Mains - Preliminary (FCDMC)
- Flow Direction
- Alternative Element ID

100-Yr Flow Depth Reduction (Ft)

- <1 inch (Not Displayed)
- 0.101 - 0.5
- 0.501 - 1.0
- 1.001 - 1.5
- 1.501 - 2.0+

Table 9 – Mockingbird 2 Flow Depth Reduction of Remaining Floodprone Buildings

Flow Depth Reduction Ranges (ft)	10-Year No. of Buildings	100-Year No. of Buildings
0.101 - 0.5	0	3
0.501 - 1.0	1	9
1.01 - 1.5	1	4
1.501 - 2.0+	0	5
Total	2	21

Table 10 – Mockingbird 2 Street Flooding Reduction

10-Year Street Flooding Reduction			100-Year Street Flooding Reduction		
Exst Length (Miles)	Proposed Length (Miles)	Reduction Length (Miles)	Exst Length (Miles)	Proposed Length (Miles)	Reduction Length (Miles)
0.21	0.09	0.12	0.44	0.12	0.32

b. Cost

The estimated cost for Alternative Mockingbird 2 is \$5,601,000. A cost summary with a breakdown according to element type is provided in **Appendix G**. The elements included in the cost estimation are discussed in **Section IV.C.2**.

Long-term maintenance of the system would include maintenance of the retention basin landscape treatment and regular sediment removal would be required from the sedimentation basin provided on Hummingbird Lane. Erosion control maintenance of the storm drain outlet at the retention basin and monitoring and sediment removal from the storm drain collection pipe would be necessary. Long-term maintenance is considered to be high as compared to the other alternatives in this improvement area due to the relative amount of underground retention provided.

c. Public Acceptance

Interaction directly with the public in two public meetings and the results of survey polling suggest that this alternative is generally in conformance with public preferences. The elements are contextually sensitive and maintain the existing aesthetic value, possibly improving the aesthetic value in the case of the landscaped surface retention basin. As mentioned previously, the existing land owner is open to further discussion of the possibility of the use of the property in this manner, and it may be consistent with their long term plans for their organization. A drainage easement would be required from one residential parcel as part of the construction of the sedimentation basin on Hummingbird Lane.

d. Constructability/Construction Phasing

This alternative has few components and would likely be constructed as a single project. The elements of this alternative may be implemented independently of the FCDMC-proposed facilities currently being planned in this area; however, the FCDMC-proposed storm drain within Mockingbird Lane would provide a means to drain the retention basins in lieu of dry wells and soil infiltration. There are no unusual or non-standard construction elements that might make construction unusually difficult. Seventeen (17) potential utility conflicts have been identified. Precise vertical and horizontal locating during future phases will determine if conflicts can be avoided. A summary of utility conflicts is provided in **Appendix F**. Construction of the alternative is dependent on reaching an agreement with the existing property owner.

3. Advantages and Disadvantages

Advantages:

- Takes advantage of existing undeveloped area
- Largest breadth of benefit area
- A potential amenity to the church
- Limits disruption to low traffic areas
- Provides benefit independently of and in tandem with FCDMC planned facilities

Disadvantages:

- Most costly
- Dependent on church's long term plans
- Requires new easements
- Underground storage facilities are more difficult to maintain

F. Mockingbird Improvement Area – Alternative: Mockingbird 3

1. Description

Figure 12 displays the elements associated with Mockingbird 3.

Figure 12 Keynotes:

1. Underground storm drain and existing channel reconstruction – 10-year design storm
2. Sediment capture basin designed for annual sediment load

Mockingbird 3 provides additional conveyance capacity to an existing channel between several private parcels east of Mockingbird Lane. Existing conditions modeling suggest that the existing channel system on the Scottsdale Plaza Resort property is adequately sized to receive this flow; this alternative does not alter existing flow paths. Channel improvements with a parallel underground storm drain pipe is expected to convey the 10-year storm event peak flow, providing benefit to the properties adjacent to the improvements. The FCDMC has preliminary plans for a 10-year storm drain collection system in Mockingbird Lane that will compliment this system. Together, the system could potentially collect up to a 50-year storm runoff for the properties between Mockingbird Lane and the Scottsdale Plaza Resort that are adjacent to the proposed storm drain.

2. Performance

a. Stormwater Management Effectiveness

Preliminary FLO-2D modeling for the 10-year storm event supports that 5 homes would be completely removed from flood hazard. For the 100-year storm event, the result is that 1 home would be completely removed from flood hazard. For the remaining floodprone buildings in the Improvement Area the anticipated reduction in flow depth at the structure for the 10-year and 100-year storm events are as shown in **Table 11**. These results include the benefit of the currently planned FCDMC facilities. There are no critical safety facilities within the improvement area; however, results support access for emergency vehicles would be improved by reducing the length of roadway experiencing significant flood depths as shown in **Table 12**. Finally, the reduction in the number of parcels experiencing flood depths exceeding 6-inches would be 16 and 11 for the 10-year and 100-year storm events respectively. There are no LID facilities as part of this alternative. The elements associated with this alternative are passive in nature; no manual or mechanical intervention during storm events is needed for them to function.

Table 11 – Mockingbird 3 Flow Depth Reduction of Remaining Floodprone Buildings

Flow Depth Reduction Ranges (ft)	10-Year No. of Buildings	100-Year No. of Buildings
0.101 - 0.5	0	2
0.501 - 1.0	2	12
1.01 - 1.5	0	7
1.501 - 2.0+	0	3
Total	2	24

100-YR Depth Reduction	
Depth Ranges	No. of Buildings
0.101 - 0.5	2
0.501 - 1.0	12
1.001 - 1.5	7
1.501 - 2.0+	3
Total	24

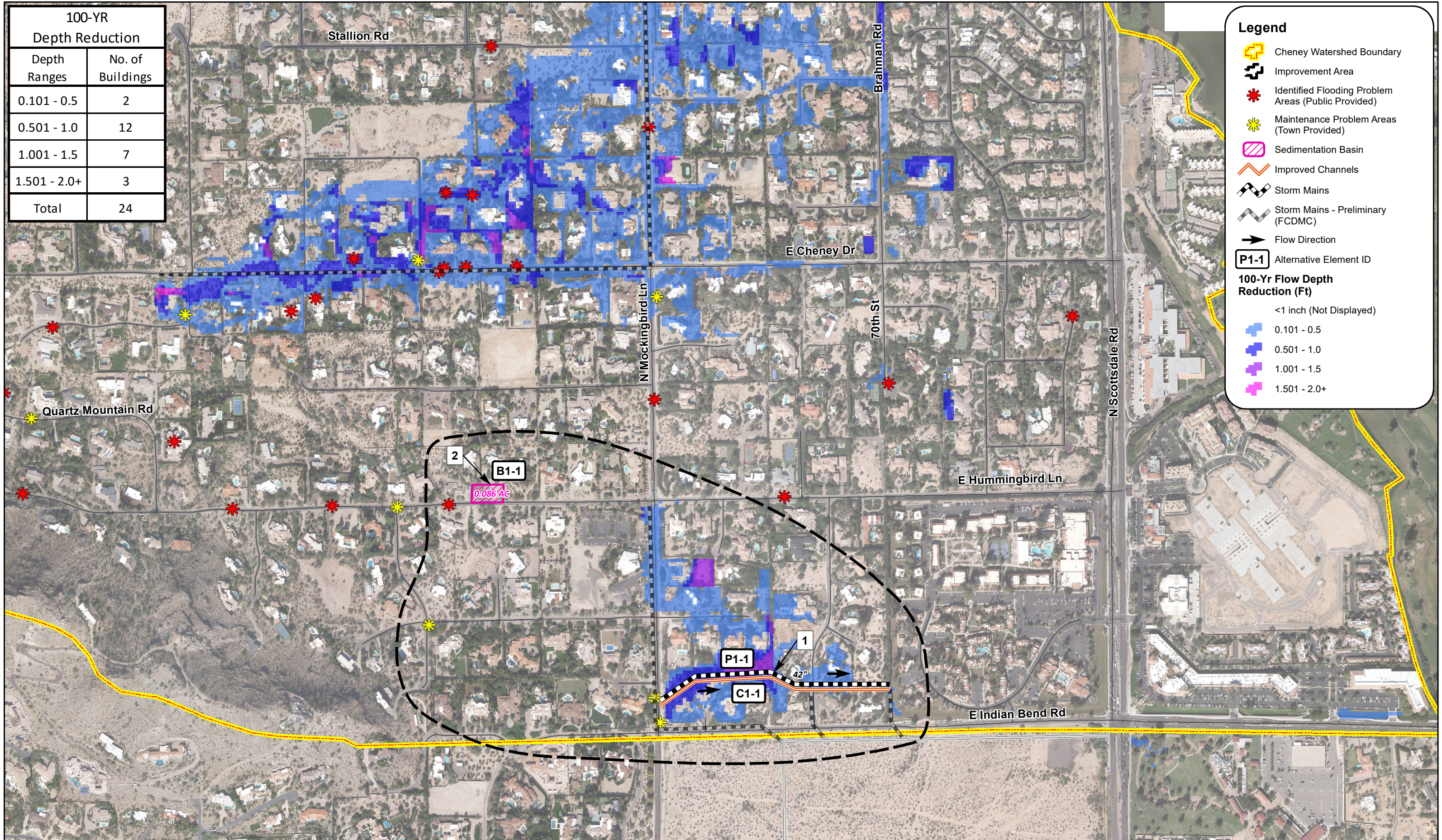

Legend

- Cheney Watershed Boundary
- Improvement Area
- Identified Flooding Problem Areas (Public Provided)
- Maintenance Problem Areas (Town Provided)
- Sedimentation Basin
- Improved Channels
- Storm Mains
- Storm Mains - Preliminary (FCDMC)
- Flow Direction
- P1-1 Alternative Element ID

100-Yr Flow Depth Reduction (Ft)

- <1 inch (Not Displayed)
- 0.101 - 0.5
- 0.501 - 1.0
- 1.001 - 1.5
- 1.501 - 2.0+



Figure 12

**Mockingbird Improvement Area
Alternative: Mockingbird 3**

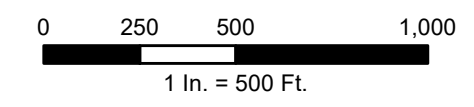

Table 12 – Mockingbird 3 Street Flooding Reduction

10-Year Street Flooding Reduction			100-Year Street Flooding Reduction		
Exst Length (Miles)	Proposed Length (Miles)	Reduction Length (Miles)	Exst Length (Miles)	Proposed Length (Miles)	Reduction Length (Miles)
0.21	0.13	0.08	0.44	0.34	0.10

b. Cost

The estimated cost for Alternative Mockingbird 3 is \$1,522,000. A cost summary with a breakdown according to element type is provided in **Appendix G**. The elements included in the cost estimation are discussed in **Section IV.C.2**.

Long-term maintenance of the system would include erosion and sedimentation control and maintenance of the storm drain outlet at the Plaza Resort channel and monitoring and sediment removal of the underground storm drain system. Long-term maintenance is considered to be low as compared to the other alternatives in this improvement area.

c. Public Acceptance

Interaction directly with the public in two public meetings and the results of survey polling suggest that this alternative is generally in conformance with public preferences. The elements are contextually sensitive and maintain the existing aesthetic value, primarily being subsurface. The project requires easements from eight residential properties and from the Scottsdale Plaza Resort for construction and maintenance of facilities.

d. Constructability/Construction Phasing

This alternative has few components and would likely be constructed as a single project. The elements of this alternative may be implemented independently of the FCDMC-proposed facilities currently being planned in this area. There are no unusual or non-standard construction elements that might make construction unusually difficult. Ten (10) potential utility conflicts have been identified. Precise vertical and horizontal locating during future phases will determine if conflicts can be avoided. A summary of utility conflicts is provided in **Appendix F**. Construction of the alternative is dependent on reaching agreements with the existing property owners.

3. Advantages and Disadvantages

Advantages:

- Less costly
- Improvements constructed adjacent to the most flood prone properties
- Little or no disruption to traffic corridors
- Makes use of existing downstream capacity at Scottsdale Plaza Resort

Disadvantages:

- Least breadth of benefit area
- Requires construction within yards
- Requires new easements

G. Quartz Mountain Improvement Area – Alternatives: Quartz Mountain 1, Quartz Mountain 2, and Quartz Mountain 3

1. Description

Figure 14, Figure 15 and Figure 16 display the elements associated with Quartz Mountain 1, Quartz Mountain 2, and Quartz Mountain 3.

Figure Keynotes:

1. Sediment collection ditch and underground storm drain
 Quartz Mountain 1 – 10-Year design storm
 Quartz Mountain 2 – 50-Year design storm
 Quartz Mountain 3 – 100-Year design storm
2. Cheney Wash bank protection measures – 100-year design storm

Alternatives Quartz Mountain 1, Quartz Mountain 2, and Quartz Mountain 3 vary only in level of protection. Each is intended to collect hillside stormwater and sediment in a roadside ditch system with stormwater inlets elevated above the ditch floor. The ditch system is not continuous though the project; rather, it is segmented between driveways and may be absent where hillside inflows are not expected. The purpose of this is to minimize the potential to alter existing flow paths should the system be overwhelmed. The collection ditches would be treated with a rock or integrally colored concrete to provide context sensitivity and to aid in sediment removal. The stormwater collected in the catch basins enters a parallel storm drain system. The storm drain enters Cheney Wash where bank protection is provided through the exiting wash bend, a length of approximately 975-feet. The change in peak flow at Cheney Drive due to changes at Quartz Mountain is not expected to be significant. The system re-routes flow locally, but does not change the volume of stormwater reaching Cheney Drive or significantly change peak timing. For cost estimation, wire-tied riprap was selected for bank protection material. Scour depths were estimated using Arizona Department of Water Resources State Standard SSA 5-96 Level 1 equations. **Figure 13** is a conceptual section of the collection system.

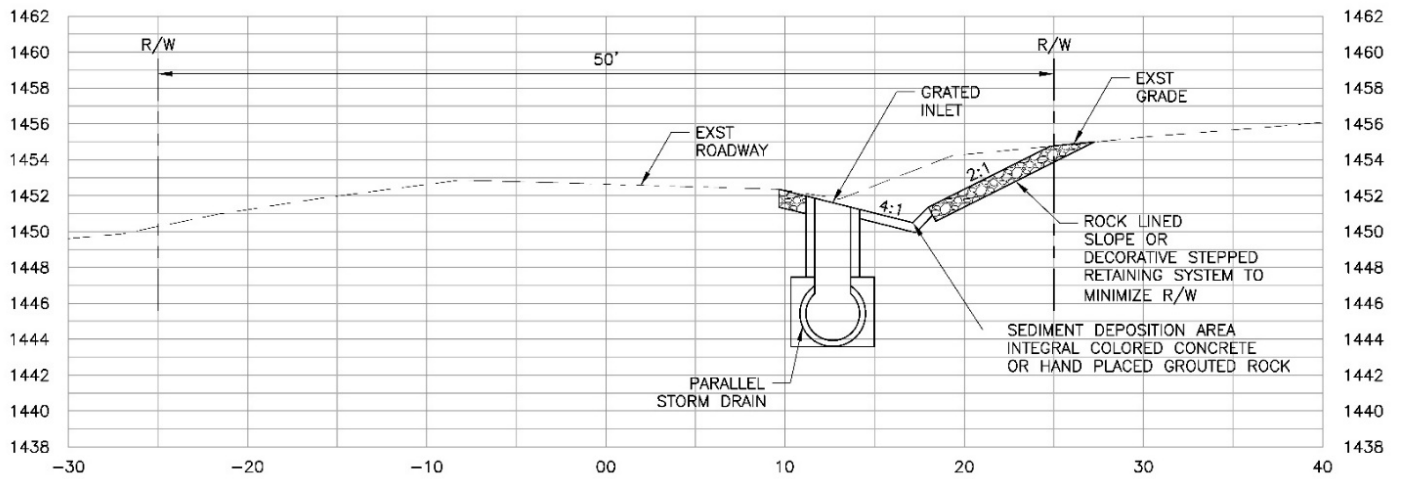

Figure 13 – Hillside Sediment Collection Ditch with Storm Drain Inlet (Facing East)

100-YR Depth Reduction	
Depth Ranges	No. of Buildings
0.101 - 0.5	1
0.501 - 1.0	0
1.001 - 1.5	0
1.501 - 2.0+	1
Total	2

Legend

- Cheney Watershed Boundary
- Improvement Area
- Identified Flooding Problem Areas (Public Provided)
- Maintenance Problem Areas (Town Provided)
- Sediment Ditch
- Embankment Protection
- Storm Mains
- Storm Mains - Preliminary (FCDMC)
- Flow Direction
- P1-1 Alternative Element ID

100-Yr Flow Depth Reduction (Ft)

- <1 inch (Not Displayed)
- 0.101 - 0.5
- 0.501 - 1.0
- 1.001 - 1.5
- 1.501 - 2.0+

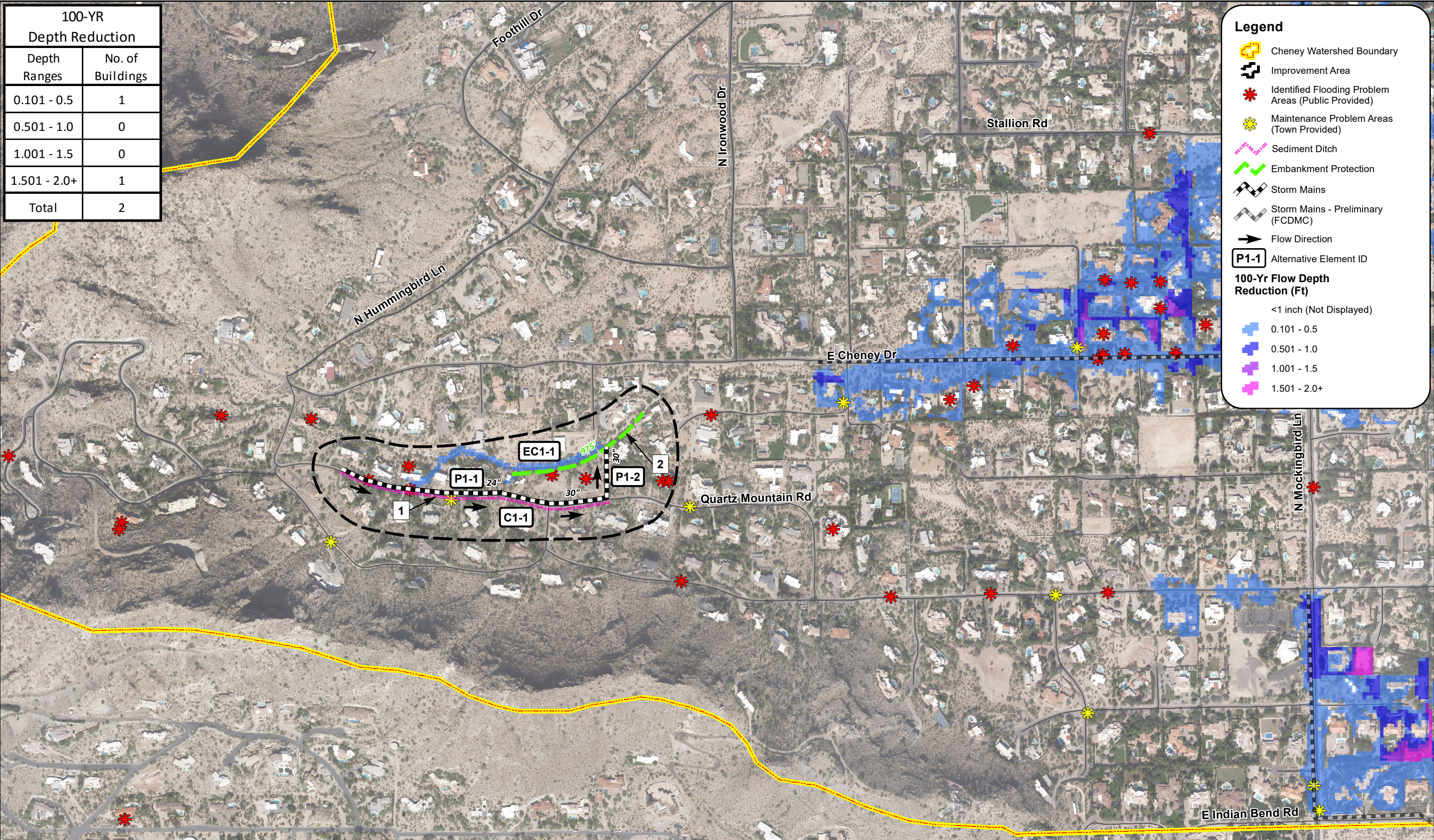
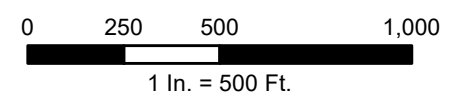

Figure 14

**Quartz Mountain Improvement Area
Alternative: Quartz Mountain 1**



100-YR Depth Reduction	
Depth Ranges	No. of Buildings
0.101 - 0.5	1
0.501 - 1.0	0
1.001 - 1.5	0
1.501 - 2.0+	1
Total	2

Legend

- Cheney Watershed Boundary
- Improvement Area
- Identified Flooding Problem Areas (Public Provided)
- Maintenance Problem Areas (Town Provided)
- Sediment Ditch
- Embankment Protection
- Storm Mains
- Storm Mains - Preliminary (FCDMC)
- Flow Direction
- P1-1 Alternative Element ID

100-Yr Flow Depth Reduction (Ft)

- <1 inch (Not Displayed)
- 0.101 - 0.5
- 0.501 - 1.0
- 1.001 - 1.5
- 1.501 - 2.0+

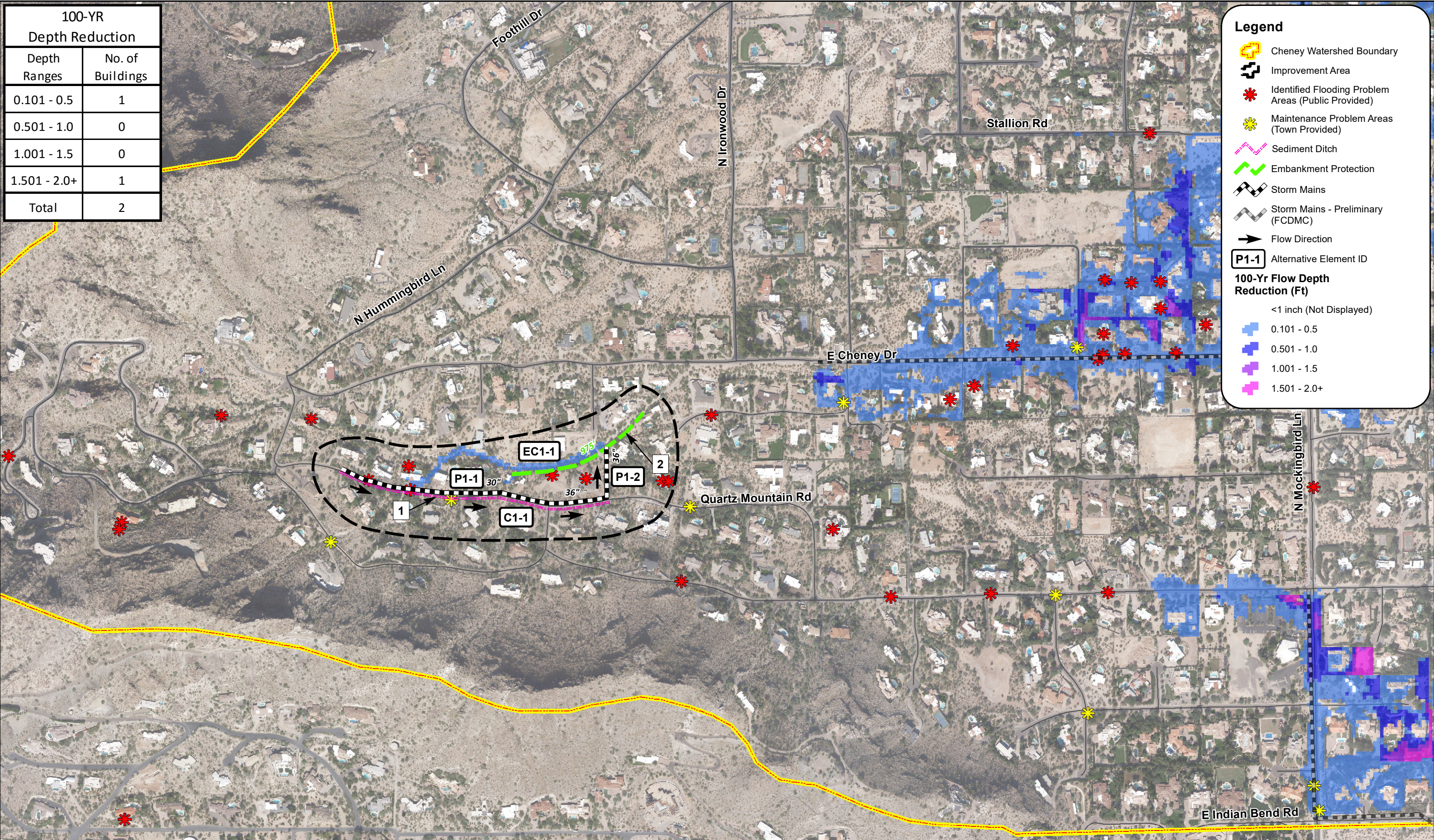
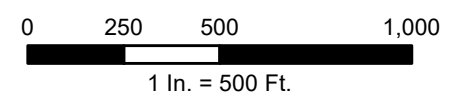
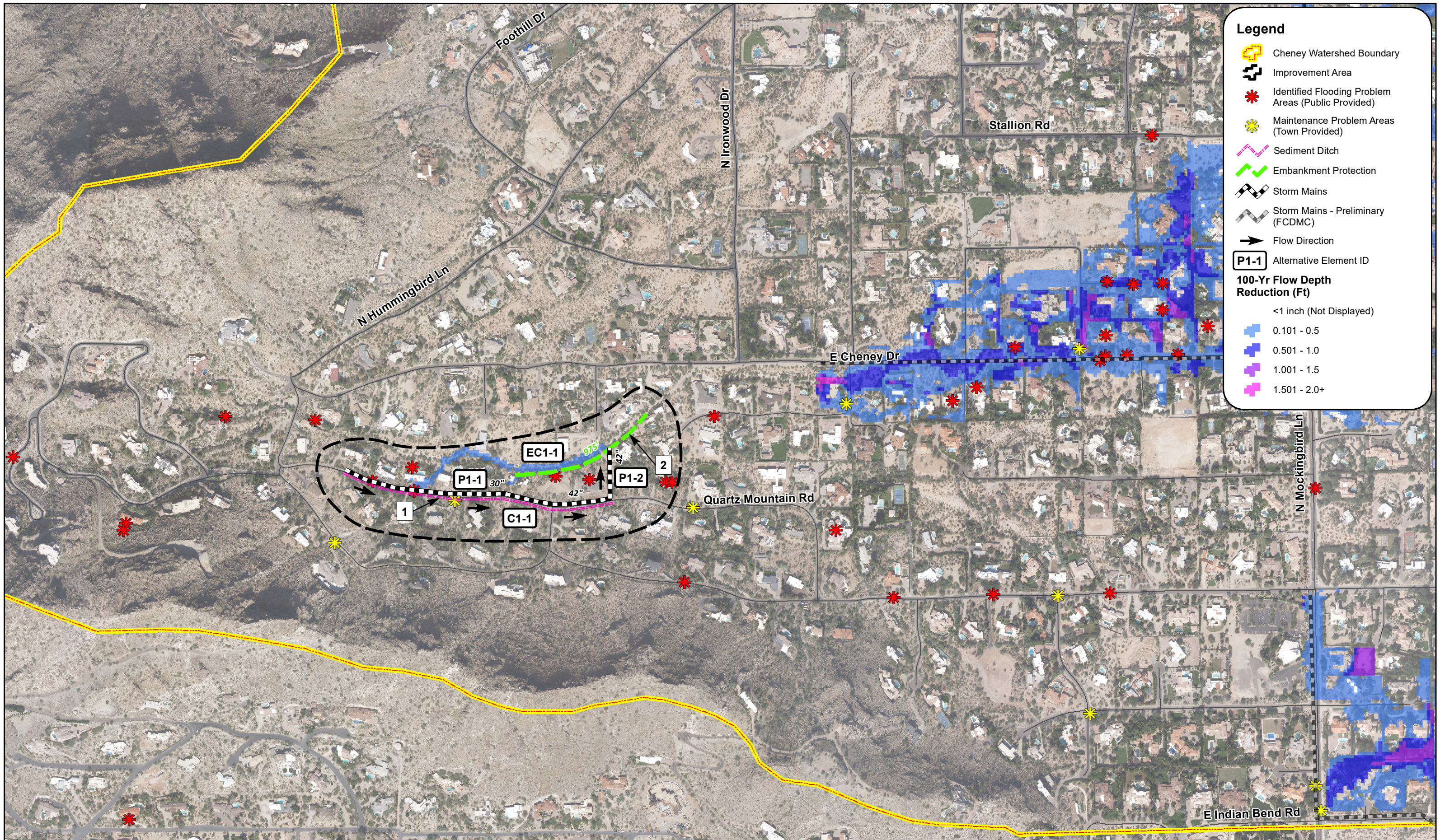

Figure 15

**Quartz Mountain Improvement Area
Alternative: Quartz Mountain 2**





Legend

- Cheney Watershed Boundary
- Improvement Area
- Identified Flooding Problem Areas (Public Provided)
- Maintenance Problem Areas (Town Provided)
- Sediment Ditch
- Embankment Protection
- Storm Mains
- Storm Mains - Preliminary (FCDMC)
- Flow Direction
- Alternative Element ID

100-Yr Flow Depth Reduction (Ft)

- <1 inch (Not Displayed)
- 0.101 - 0.5
- 0.501 - 1.0
- 1.001 - 1.5
- 1.501 - 2.0+

2. Performance

a. Stormwater Management Effectiveness

Each alternative is expected to provide flood protection to eight properties, immediately north of Quartz Mountain Road, in capacity equal to their associated design storm event (level of protection). The stormwater problems in this area are predominantly shallow fast moving runoff from the steep mountain slopes entering residences and depositing sediment on the roadways and within properties. As such, FLO-2D modeling results are not descriptive in conveying the stormwater risk or the potential benefit from the modeled improvements; therefore, depth reduction results are not provided for these alternatives. There are no critical safety facilities within the improvement area; however, access for emergency vehicles would be improved by reducing debris and crossing runoff from Quartz Mountain Road. There are no LID facilities as part of this alternative.

Bank protection within Cheney Wash is recommended to be designed for the expected long term scour and the general and local scour associated with the peak 100-year storm event. The elements associated with this alternative are passive in nature; no manual or mechanical intervention during storm events is needed for them to function.

b. Cost

The estimated cost for each alternative within the Quartz Mountain Improvement Area are:

Quartz Mountain 1: \$3,028,000

Quartz Mountain 2: \$3,084,000

Quartz Mountain 3: \$3,110,000

A cost summary with a breakdown according to element type is provided in **Appendix G**. The elements included in the cost estimation are discussed in **Section IV.C.2**.

Long-term maintenance of the system would include removal of sediment from the sediment collection ditch, monitoring of the underground storm drain system for damage and/or clogging, and monitoring of scour and repair of wire-tied riprap bank protection within Cheney Wash. Long-term maintenance would be expected to increase with design storm level of protection, but not greatly so.

c. Public Acceptance

Interaction directly with the public in two public meetings and the results of survey polling suggest that this alternative is generally in conformance with public preferences. The elements are contextually sensitive and maintain the existing aesthetic value, primarily being subsurface. However, the sediment collection ditch may be visually objectionable to some. The construction of the sediment collection system will likely require 5 feet to 10 feet wide easements from eight residential properties for construction and maintenance of facilities.

d. Constructability/Construction Phasing

This alternative has few components and would likely be constructed as a single project. Construction of the sediment collection ditch against the steep mountain slope may require special provisions for slope

stability. Also, the existing roadway is narrow, making access to construction equipment more difficult. Thirty-one (31) potential utility conflicts have been identified within the relatively narrow roadway corridor. Precise vertical and horizontal locating during future phases will determine if conflicts can be avoided. A summary of utility conflicts is provided in **Appendix F**. Construction of the alternative is dependent on reaching agreements with the existing property owners.

3. Advantages and Disadvantages

The advantages and disadvantages relative to the alternatives proposed for consideration within the Quartz Mountain Improvement Area are defined by the level of protection (design storm) and cost (provided in Section 2b) of each. Long-term maintenance would be expected to increase with design storm level of protection, but not greatly so.

H. *Maverick Improvement Area – Alternative: Maverick 1*

1. *Description*

Figure 17 displays the elements associated with Maverick 1.

Figure 17 Keynotes:

1. Underground storm drain and existing channel reconstruction – 10-year design storm

Maverick 1 provides additional conveyance capacity to an existing channel between several private parcels with an outfall to Indian Bend Wash. Channel improvements with a parallel underground storm drain pipe are expected to convey the 10-year storm event peak flow, providing benefit to the properties adjacent to the improvements and southeast of the improvements along 68th Street. The FCDMC plans for a 10-year storm drain collection system in Invergordon Road will compliment this system. Together, the system is expected to collect up to the 50-year stormwater runoff for the properties along the proposed alignment between Invergordon Road and Indian Bend Wash.

2. *Performance*

a. *Stormwater Management Effectiveness*

Preliminary FLO-2D modeling for the 10-year storm event supports that 5 homes would be completely removed from flood hazard. For the 100-year storm event, the result is that 2 homes would be completely removed from flood hazard. For the remaining floodprone buildings in the Improvement Area the anticipated reduction in flow depth at the structure for the 10-year and 100-year storm events are as shown in **Table 13**. These results include the benefit of the currently planned FCDMC facilities. There are no critical safety facilities within the improvement area; however, results support access for emergency vehicles would be improved by reducing the length of roadway experiencing significant flood depths as shown in **Table 14**.

Finally, the reduction in the number of parcels experiencing flood depths exceeding 6-inches would be 17 and 5 for the 10-year and 100-year storm events respectively. There are no LID facilities as part of this alternative. The elements associated with this alternative are passive in nature; no manual or mechanical intervention during storm events is needed for them to function.

Table 13 – Maverick 1 Flow Depth Reduction of Remaining Floodprone Buildings

Flow Depth Reduction Ranges (ft)	10-Year No. of Buildings	100-Year No. of Buildings
0.101 - 0.5	0	1
0.501 - 1.0	4	16
1.01 - 1.5	0	5
1.501 - 2.0+	0	1
Total	4	23

100-YR Depth Reduction	
Depth Ranges	No. of Buildings
0.101 - 0.5	1
0.501 - 1.0	16
1.001 - 1.5	5
1.501 - 2.0+	1
Total	23

Legend

- Cheney Watershed Boundary
- Improvement Area Boundary
- Identified Flooding Problem Areas (Public Provided)
- Maintenance Problem Areas (Town Provided)
- Improved Channels
- Storm Mains
- Storm Mains - Preliminary (FCDMC)
- Flow Direction
- P1-1 Alternative Element ID

100-Yr Flow Depth Reduction (Ft)

- <1 inch (Not Displayed)
- 0.101 - 0.5
- 0.501 - 1.0
- 1.001 - 1.5
- 1.501 - 2.0+



Table 14 – Maverick 1 Street Flooding Reduction

10-Year Street Flooding Reduction			100-Year Street Flooding Reduction		
Exst Length (Miles)	Proposed Length (Miles)	Reduction Length (Miles)	Exst Length (Miles)	Proposed Length (Miles)	Reduction Length (Miles)
0.41	0.20	0.21	0.70	0.38	0.32

b. Cost

The estimated cost for Alternative Maverick 1 is \$2,606,000. A cost summary with a breakdown according to element type is provided in **Appendix G**. The elements included in the cost estimation are discussed in **Section IV.C.2**.

Long-term maintenance of the system would include erosion and sedimentation control and maintenance of the storm drain outlet at Indian Bend Wash and monitoring and sediment removal of the underground storm drain system pipes. Long-term maintenance is considered to be low as compared to the other alternative in this improvement area.

c. Public Acceptance

Interaction directly with the public in two public meetings and the results of survey polling suggest that this alternative is generally in conformance with public preferences. The elements are contextually sensitive and maintain the existing aesthetic value, primarily being subsurface. The project requires easements from 8 residential properties for construction and maintenance of facilities.

d. Constructability/Construction Phasing

This alternative has few components and would likely be constructed as a single project. The elements of this alternative may be implemented independently of the FCDMC-proposed facilities currently being planned in this area. There are no unusual or non-standard construction elements that might make construction unusually difficult. Twenty-five (25) potential utility conflicts have been identified. Precise vertical and horizontal locating during future phases will determine if conflicts can be avoided. A summary of utility conflicts is provided in **Appendix F**. Construction of the alternative is dependent on reaching agreements with the existing property owners.

3. Advantages and Disadvantages

Advantages:

- Less costly
- Improvements constructed on the most flood prone properties
- Little or no disruption to traffic corridors

Disadvantages:

- Less breadth of benefit area
- Requires construction within yards

- Requires new easements
- More prone to sediment and debris

1. Maverick Improvement Area – Alternative: Maverick 2

1. Description

Figure 18 displays the elements associated with Maverick 2.

Figure 18 Keynotes:

1. Underground storm drain and existing channel improvements – 10-year design storm
2. Underground storm drain in Maverick Road – 50-year design storm
3. Sediment capture basin designed for annual sediment load
4. Early construction of FCDMC underground storm drain in Invergordon Road – 10-year design storm

Maverick 2 provides additional conveyance capacity to an existing channel between several private parcels with an outfall at Indian Bend Wash. Channel improvements with a parallel underground storm drain pipe are expected to convey the 10-year storm event peak flow, providing benefit to the properties adjacent to the improvements and southeast of the improvements along 68th Street. Further, a new storm drain system in Maverick Road with a 50-year design storm capacity increases the benefit to properties along Maverick Road. At the junction with the 10-Year storm drain system (Keynote 1) a split occurs. The split flow condition is proposed at the intersection of Maverick and Invergordon roads. The 50-year peak flow is divided between two systems, each with approximately a 10-year capacity. A 10-year storm drain system then continues northerly in Invergordon Road, extending to Indian Bend Wash. An existing storm drain in Invergordon Road is assumed to be fully utilized by runoff generated west of Invergordon Road and delivered via Mockingbird Lane. The FCDMC currently has preliminary plans for a 10-year storm drain collection system in Maverick Road and Invergordon Road – this project represents an upsizing to that system on Maverick Road and early construction of that system on Invergordon Road between Maverick Road and Mockingbird Lane.

2. Performance

a. Stormwater Management Effectiveness

Preliminary FLO-2D modeling for the 10-year storm event supports that 7 homes would be completely removed from flood hazard. For the 100-year storm event, the result is that 2 homes would be completely removed from flood hazard. For the remaining floodprone buildings in the Improvement Area the anticipated reduction in flow depth at the structure for the 10-year and 100-year storm events are as shown in **Table 15**. These results include the benefit of the currently planned FCDMC facilities. There are no critical safety facilities within the improvement area; however, results support access for emergency vehicles would be improved by reducing the length of roadway experiencing significant flood depths as shown in **Table 16**.

Finally, the reduction in the number of parcels experiencing flood depths exceeding 6-inches would be 20 and 6 for the 10-year and 100-year storm events respectively. There are no LID facilities as part of this alternative. The elements associated with this alternative are passive in nature; no manual or mechanical intervention during storm events is needed for them to function.

100-YR Depth Reduction	
Depth Ranges	No. of Buildings
0.101 - 0.5	1
0.501 - 1.0	19
1.001 - 1.5	3
1.501 - 2.0+	0
Total	23

Legend

- Cheney Watershed Boundary
- Improvement Area
- Identified Flooding Problem Areas (Public Provided)
- Maintenance Problem Areas (Town Provided)
- Sedimentation Basin
- Improved Channels
- Storm Mains
- Existing Storm Mains (Paradise Valley)
- Storm Mains - Preliminary (FCDMC)
- Flow Direction
- P1-1** Alternative Element ID

100-Yr Flow Depth Reduction (Ft)

- <1 inch (Not Displayed)
- 0.101 - 0.5
- 0.501 - 1.0
- 1.001 - 1.5
- 1.501 - 2.0+

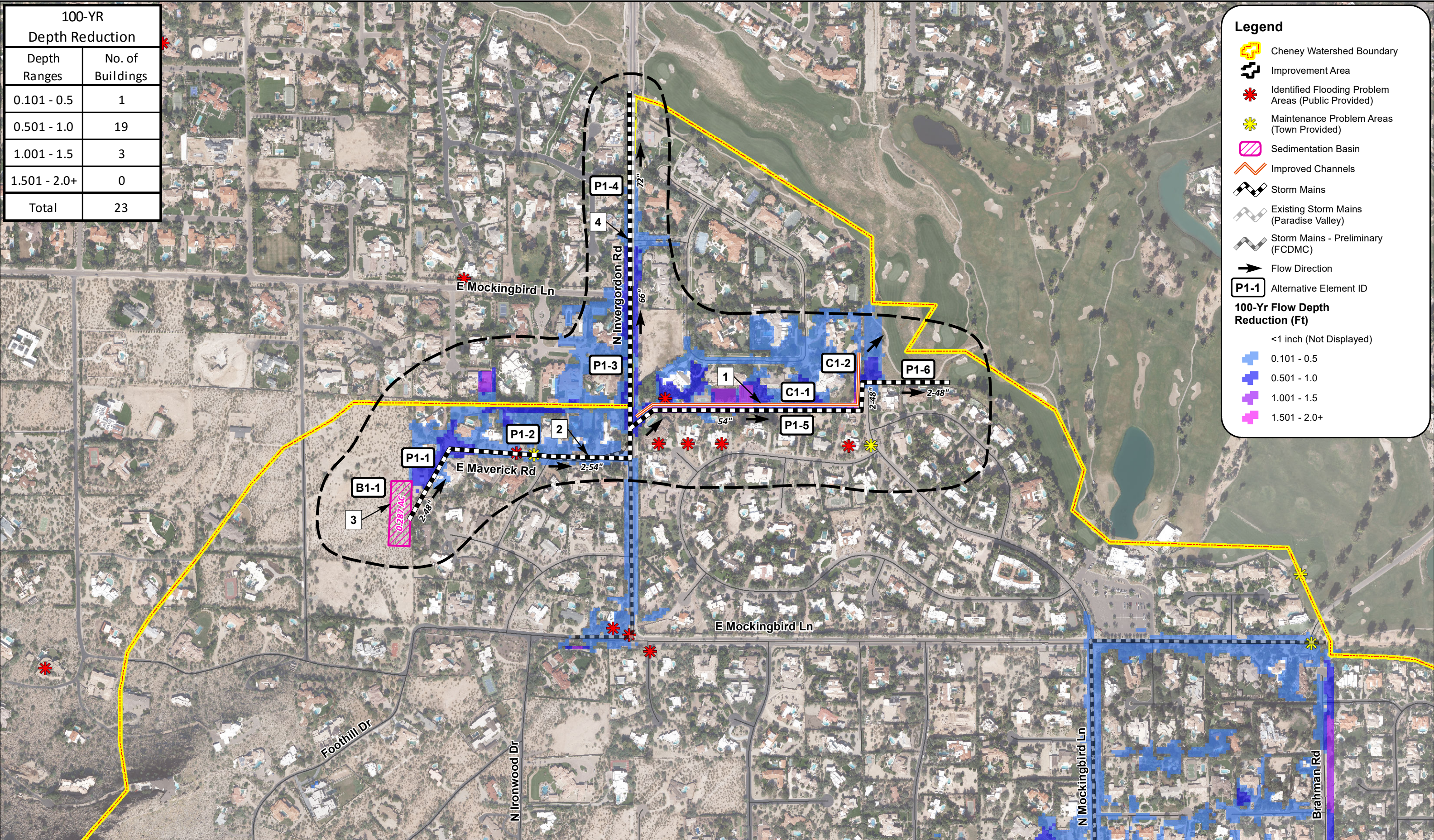

Table 15 – Maverick 2 Flow Depth Reduction of Remaining Floodprone Buildings

Flow Depth Reduction Ranges (ft)	10-Year No. of Buildings	100-Year No. of Buildings
0.101 - 0.5	0	1
0.501 - 1.0	2	19
1.01 - 1.5	0	3
1.501 - 2.0+	0	0
Total	2	23

Table 16 – Maverick 2 Street Flooding Reduction

10-Year Street Flooding Reduction			100-Year Street Flooding Reduction		
Exst Length (Miles)	Proposed Length (Miles)	Reduction Length (Miles)	Exst Length (Miles)	Proposed Length (Miles)	Reduction Length (Miles)
0.41	0.26	0.15	0.70	0.40	0.30

b. Cost

The estimated cost for Alternative Maverick 2 is \$3,451,000. A cost summary with a breakdown according to element type is provided in **Appendix G**. The elements included in the cost estimation are discussed in **Section IV.C.2**.

Long-term maintenance of the system would include regular sediment removal from the sedimentation basin (B1-1) and erosion and sedimentation control and maintenance of the storm drain outlet at Indian Bend Wash. In addition, regular monitoring and sediment removal of the underground storm drain system pipes would be necessary. Long-term maintenance is considered to be high as compared to the other alternative in this improvement area.

c. Public Acceptance

Interaction directly with the public in two public meetings and the results of survey polling suggest that this alternative is generally in conformance with public preferences. The elements are contextually sensitive and maintain the existing aesthetic value, primarily being subsurface. The project requires easements from 9 residential properties for construction and maintenance of facilities.

d. Constructability/Construction Phasing

This alternative has few components and would likely be constructed as a single project. The elements of this alternative may be implemented independently of the FCDMC-proposed facilities currently being

planned in this area; however, because elements P1-3 and P1-4 represent an early construction of these facilities, any FCDMC component of funding would be dependent on the FCDMC prioritization schedule. There are no unusual or non-standard construction elements that might make construction unusually difficult. Fifty-one (51) potential utility conflicts have been identified. Precise vertical and horizontal locating during future phases will determine if conflicts can be avoided. A summary of utility conflicts is provided in **Appendix F**. Construction of the alternative is dependent on reaching agreements with the existing property owners.

3. Advantages and Disadvantages

Advantages:

- Very context sensitive
- Larger breadth of benefit area
- Less prone to sediment and debris

Disadvantages:

- More costly
- Higher long-term maintenance
- Requires construction within yards
- Requires new easements
- Dependent on FCDMC prioritization schedule for cost sharing of elements P1-4 and P1-5
- Potential for significant traffic disruption of N. Invergordon Road

VI. Evaluation of Alternatives

A. Performance Criteria

Selection of the preferred alternatives is based on an evaluation to determine which alternative from each Improvement area best meets the performance criteria which were identified as important for implementation of the stormwater master plan. This section describes the performance criteria used in the evaluation and presents an evaluation matrix for use in selecting the preferred alternative. The following performance criteria have been developed for consideration as a basis for identifying and evaluating alternatives.

1. Stormwater Management Effectiveness

a. Public Safety

Measures the benefit to public safety facilities. Alternatives receiving a high rating would provide all-weather street crossings and driveways for emergency vehicles and eliminate flooding of critical facilities such as hospitals, police and fire stations, and public and private utility facilities that are vital to maintaining or restoring normal services to flooded areas before, during and after a flood. This criteria excludes damage or inundation of private property that does not serve a role in public safety.

b. Level of Flood Mitigation Provided

Measures the level of flood mitigation, i.e. the design storm return period, used as the basis of design. Alternatives receiving a high rating would be designed to a 100-year or higher level of mitigation. Alternatives receiving a low rating would provide little increase in the level of flood mitigation provided.

c. Breadth of Flood Mitigation Provided

Measures the geographical extent of flood mitigation. Alternatives receiving a high rating would provide the selected level of mitigation to the vast majority of flood-prone properties, roads, critical facilities, etc. within the alternative's Improvement Area.

d. Use of LID Opportunities

Measures the degree to which alternatives maximize the available potential for the use of contextually sensitive Low Impact Development (LID) opportunities to provide flood mitigation. Alternatives receiving a high rating would make significant use of the available LID opportunities in the hazard area, such as rainfall harvesting, on-site retention, impervious pavements, and bio-swales. Alternatives receiving a low rating would have little or no LID measures as part of the proposed facilities.

e. Passive vs. Active Interventional Systems

Measures the dependence of the mitigation system on active intervention systems. Alternatives depending largely on manual or mechanical intervention to function during storm events, i.e. the operation of gates, pumps, or road closures, would receive a low rating. Alternatives that are completely passive in nature would receive a high rating.

2. Cost

a. Initial Cost

Measures the relative cost to design and construct the project. This item includes any anticipated land acquisition costs. The highest cost alternative receives a rating of 1; remaining alternatives are given a rating relative to 1, the highest cost alternative, and 10, representing zero cost.

b. Cost Sharing / Grant / Outside Funding

Measures the potential of outside funding for which an alternative is eligible. Alternatives receiving a high rating have significant funding sources available and/or multiple partnering opportunities. Alternatives receiving a low rating have few or no outside funding sources and/or partnering opportunities available. This does not include FCDMC cost sharing for separate FCDMC-planned improvements adjacent to and/or complimentary to a given alternative.

c. Maintains, Replaces, or Expands an Existing Asset

Measures the degree to which alternatives make use of existing stormwater infrastructure having available capacity. Alternatives that fully utilize the existing capacity of an existing stormwater facility receive a high rating. Alternatives that leave existing stormwater facilities with existing capacity unutilized receive a low rating.

d. Life-Cycle Cost

Measures the ease, frequency, and ongoing cost of maintenance. Alternatives receiving a low rating would include facilities that require frequent maintenance such as mowing, sediment removal, and cleaning; require costly maintenance procedures such as watering or specialized equipment, or pose maintenance challenges such as difficult access. Alternatives receiving a high rating would include facilities that require little or no maintenance by Town forces.

3. Public Acceptance

a. Conformance with Public Meeting and Survey Polling

Measures the conformance with the preferences of the impacted public through the public outreach process. Right-of-way and easements are considered integral to this criteria, rather than a separate performance criteria, because public surveys suggest that residents do not indicate that new easements are necessarily either a positive or negative outcome.

b. Maintains or Improves Aesthetic Value

Measures the conformance with the natural desert landscape context of the area. Alternatives receiving a high score require little or no visible hard-scape materials, such as underground storm drain systems and naturally landscape storage areas, and are constructed within already developed corridors of the Town. Alternatives receiving a low score would primarily be composed of features such as lined channels with construction in currently undisturbed areas of the Town.

c. Avoids Disruption to the Public

Measures the impact to the day-to-day operations of the Town during construction of the alternative as well as from the completed project. Alternatives receiving a low rating would include facilities that require construction in public transportation corridors and critical public use facilities, leave surface features that could pose hazards to pedestrians or inhibit mobility. Alternatives receiving a high rating would include facilities constructed away from roadways or heavy traffic areas. Alternatives constructed concurrent with already planned public improvements would receive a favorable rating because they do not add appreciably to disruptions that are already caused by the improvement project itself.

d. Multiuse Opportunities

Measures the value added through construction of recreational opportunities, such as public parks and play areas within retention facilities or multiuse pathways within channel corridors. For alternatives receiving a high rating multiuse facilities would be incorporated into a significant portion of the facility design. Alternatives receiving a low rating would have little or no multi-use features within the proposed facilities.

4. Constructability / Construction Phasing

a. Independence from FCDMC Prioritization Schedule

Measures the relative flexibility provided to the Town to implement the alternative independently of the FCDMC prioritization and funding schedule. Alternatives that represent an upsizing of a proposed FCDMC facility would receive a low rating. Alternatives receiving a high rating are completely independent of the FCDMC schedule of prioritization and funding.

b. Allows for Phasing with Immediate Benefit of Initial Phases

Alternatives receiving a low rating would require constructing larger projects at one time with the higher upfront costs to allow it to be put in service for its intended purpose. Alternatives receiving a high rating would include facilities that can be easily phased to allow spreading of implementation costs over a longer time.

c. Ease of Construction

Alternatives receiving a low rating would include facilities that have non-standard elements that are not readily available from multiple sources and construction challenges such as deep trenches, complex utility crossings or relocations, confined work spaces, etc. Alternatives receiving a high rating make use of standard, straight forward elements and construction practices.

d. Permitting

Requirements to obtain permits and comply with associated special requirements detracts from constructability. Significant permitting would be required for jurisdictional waters of the U.S. or from significant utility providers for construction within their right-of-way or crossing their facilities. Lengthy lead times to obtain permits would also detract from constructability as compared to alternatives that require no, or few, permits.

B. Evaluation Matrices

Two evaluation matrices has been developed to provide a systematic means to selecting and prioritizing the alternatives presented within this report. The Preferred Alternative Selection Matrix ranks alternatives within each Improvement Area. An evaluator selects a score between 1 and 10 for each performance criteria, indicating how well a particular alternative performs relative to the other alternatives within the same Improvement Area. Once the preferred alternative within each Improvement Area are determined, the Preferred Alternatives Prioritization Matrix ranks the alternatives in order of highest to lowest priority; this time providing a score between 1 and 10 for each performance criteria relative the preferred alternatives from each Improvement Area. This allows the initial selection of the preferred alternatives to be simpler for those filling out the evaluation; the evaluator is only scoring alternatives relative to others in their own Improvement Area. This may then be used by Town staff in incorporation the projects in the Town Capital Improvement Program. The Category and subcategory weightings have been established in coordination with the Town. Both matrices as scored by Dibble Engineering are presented in **Appendix H**. In addition, blank versions of the matrices are provided should there be a need to complete the evaluation by hand.

C. Next Steps

The next step in the alternatives evaluation process is to solicit matrix evaluations from those project stakeholders that the Town believes are instrumental to the selection of the preferred alternatives. These could be representatives from departments within the Town such as Public Works, Community Development, Finance, and the Town Manager. Once all alternatives matrices have been received the scores will be combined and a final list of preferred alternatives and prioritization ranking will be include in a final version of this report.

VII. References

1. Arizona Department of Water Resources, *State Standard for Watercourse System Sediment Balance 5-96*, 1996.
2. Dibble Engineering, *Paradise Valley Cheney Watershed Hazards Identification Memorandum*, March 2016.
3. FHWA, *HDS-5 Hydraulic Design of Highway Culverts*, 2015.
4. Flood Control District of Maricopa County. *Drainage Design Manual for Maricopa County, Arizona, Hydrology*. August 2013.
5. Flood Control District of Maricopa County. *Drainage Design Manual for Maricopa County, Arizona, Hydraulics*. August 2013.
6. Flood Control District of Maricopa County. *Drainage Policies and Standards*. January 26, 2016.
7. Gavin & Barker Inc., *Lower Indian Bend Wash Area Drainage Master Study/Plan Data Collection Report*, February, 2013.
8. TY Lin International, *Lower Indian Bend Wash Area Drainage Master Study/Plan Offsite Hydrology Study Technical Memorandum*, February 27, 2015.