

PRELIMINARY PLAT FOR

"THE VILLAS AT MOUNTAIN SHADOWS - AMENDED - CONDOMINIUMS"

A CONDOMINIUM UPON TRACTS 'C' AND 'E' OF "THE VILLAS AT MOUNTAIN SHADOWS - AMENDED" AS RECORDED IN BOOK ____ OF MAPS, PAGE __, M.C.R. AND SITUATED IN THE SOUTHEAST QUARTER OF SECTION 8, TOWNSHIP 2 NORTH, RANGE 4 EAST, OF THE GILA AND SALT RIVER BASE AND MERIDIAN, MARICOPA COUNTY, ARIZONA

COUNTY RECORDER

CVL
CONSULTANTS
4550 North 12th Street
Phoenix, Arizona 85014
602-264-6831
www.cvlci.com

NOTES

- THE BOUNDARIES OF EACH UNIT ARE AS FOLLOWS:
 - THE VERTICAL BOUNDARIES ARE THE INTERIOR FINISHED SURFACES OF THE PERMIETER WALLS OF THE UNIT;
 - THE LOWER HORIZONTAL BOUNDARY IS THE TOP SURFACE OF THE FLOOR SLAB BENEATH THE UNIT; AND
 - THE UPPER AND LOWER HORIZONTAL BOUNDARIES OF EACH UNIT SHALL BE FROM THE UNFINISHED FLOOR OR EACH UNIT TO THE UNFINISHED CEILING OF EACH UNIT.
- THE COMMON ELEMENTS OF THE VILLAS AT MOUNTAIN SHADOWS - CONDOMINIUMS, WILL CONSIST OF ALL THE PROPERTY WITHIN THE BOUNDARIES OF THE CONDOMINIUM AS SHOWN ON THIS CONDOMINIUM PLAT, EXCEPT FOR THE UNITS.
- TIES SHOWN ARE TO OUTSIDE FACE OF BUILDINGS (GROUND LEVEL).
- NO POWER POLES EXIST ON-SITE.
- BUILDING HEIGHT WILL COMPLY WITH THE MOUNTAIN SHADOWS RESORT SPECIAL USE PERMIT REQUIREMENTS.

OWNER / DEVELOPER

MTS LAND LLC, A DELAWARE LIMITED LIABILITY COMPANY
18201 VON KARMAN AVENUE, SUITE 950
IRVINE, CALIFORNIA 92612
PHONE: (949) 476-2200
CONTACT: ROBERT A. FLAXMAN, CEO

ARCHITECT

JZMK PARTNERS
3080 BRISTOL STREET, SUITE 650
COSTA MESA, CALIFORNIA 92626
PHONE: (714) 426-6900
CONTACT: BRYAN STADLER

ENGINEER

COE & VAN LOO CONSULTANTS, INC.
4550 NORTH 12TH STREET
PHOENIX, ARIZONA 85014
PHONE: (602) 264-6831
FAX: (602) 264-0928
CONTACT: JOSEF PAPPAS, P.E.

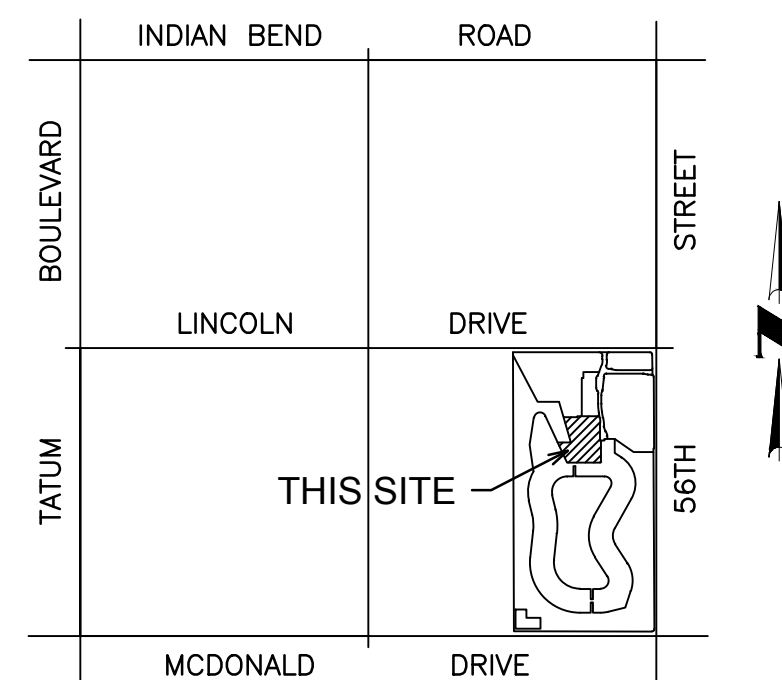

VICINITY MAP
(NOT-TO-SCALE)

DEDICATION

STATE OF ARIZONA)
COUNTY OF MARICOPA)SS

KNOW ALL MEN BY THESE PRESENTS:

THAT MTS LAND, LLC, A DELAWARE LIMITED LIABILITY COMPANY, AS OWNER, HAS SUBDIVIDED UNDER THE NAME OF "THE VILLAS AT MOUNTAIN SHADOWS - AMENDED - CONDOMINIUM" A CONDOMINIUM UPON TRACTS 'C' AND 'E' OF "THE VILLAS AT MOUNTAIN SHADOWS - AMENDED" AS RECORDED IN BOOK ____ OF MAPS, PAGE __, M.C.R. AND SITUATED IN THE SOUTHEAST QUARTER OF SECTION 8, TOWNSHIP 2 NORTH, RANGE 4 EAST, OF THE GILA AND SALT RIVER BASE AND MERIDIAN, MARICOPA COUNTY, ARIZONA, AS SHOWN PLATTED HEREON AND HEREBY PUBLISHES THIS PRELIMINARY PLAT AND DECLARES THAT THIS PLAT SETS FORTH THE LOCATION AND GIVES THE DIMENSIONS OF THE BOUNDARIES OF THE CONDOMINIUM UNITS, AND THAT EACH UNIT SHALL BE KNOWN BY THE NUMBER OR LETTER GIVEN EACH RESPECTIVELY ON SAID PLAT.

IN WITNESS WHEREOF:

MTS LAND, LLC, A DELAWARE LIMITED LIABILITY COMPANY, AS OWNER OF THE LAND DESCRIBED HEREIN, HAS CAUSED ITS NAME TO BE AFFIXED AND THE SAME TO BE ATTESTED BY THE SIGNATURE OF THE UNDERSIGNED DULY AUTHORIZED OFFICER.

MTS LAND, LLC, A DELAWARE LIMITED LIABILITY COMPANY

BY: _____ DATE: _____
ROBERT A. FLAXMAN
ITS: AUTHORIZED SIGNATORY

ACKNOWLEDGEMENT

STATE OF CALIFORNIA)
COUNTY OF ORANGE)SS

ON _____ BEFORE ME, ANN M. VERA, A NOTARY PUBLIC,

PERSONALLY APPEARED ROBERT A. FLAXMAN, WHO PROVED TO ME ON THE BASIS OF SATISFACTORY EVIDENCE TO BE THE PERSON WHOSE NAME IS SUBSCRIBED TO THE WITHIN INSTRUMENT AND ACKNOWLEDGED TO ME THAT HE EXECUTED THE SAME IN HIS AUTHORIZED CAPACITY, AND THAT BY HIS SIGNATURE ON THE INSTRUMENT THE PERSON, OR THE ENTITY UPON BEHALF OF WHICH THE PERSON ACTED, EXECUTED THE INSTRUMENT.

I CERTIFY UNDER PENALTY OF PERJURY UNDER THE LAWS OF THE STATE OF CALIFORNIA THAT THE FOREGOING PARAGRAPH IS TRUE AND CORRECT.

WITNESS MY HAND AND OFFICIAL SEAL.

SIGNATURE: _____
ANN M. VERA

APPROVAL

APPROVED BY THE TOWN COUNCIL OF THE TOWN OF PARADISE VALLEY, ARIZONA THIS _____ DAY OF _____, 2015.

BY: _____
MAYOR
ATTEST: _____
TOWN CLERK

TOWN ENGINEER

PLANNING DIRECTOR

CERTIFICATION

I, LARRY E. SULLIVAN, HEREBY CERTIFY THAT I AM A REGISTERED LAND SURVEYOR IN THE STATE OF ARIZONA, THAT THIS MAP, CONSISTING OF FOURTEEN (14) SHEETS, CORRECTLY REPRESENTS A BOUNDARY SURVEY MADE UNDER MY SUPERVISION DURING THE MONTH OF JUNE, 2015. THAT THE SURVEY IS TRUE AND COMPLETE AS SHOWN, THAT ALL MONUMENTS SHOWN ACTUALLY EXIST OR WILL BE SET AS SHOWN, THAT THEIR POSITIONS ARE CORRECTLY SHOWN AND THAT SAID MONUMENTS ARE SUFFICIENT TO ENABLE THE SURVEY TO BE RETRACED.

BY: _____
LARRY E. SULLIVAN
REGISTRATION NUMBER 22782
4550 N. 12TH STREET
PHOENIX, ARIZONA 85014
(602)-264-6831
CVLSURVEY@CVLCCI.COM

DRAINAGE EASEMENT RESTRICTIONS

PURSUANT TO A.R.S. 9-463.01 (C), AND SECTION 6-4 (E)(J), 8-7-1 ET. SEQ. AND 6-3-8 OF THE CODE OF ORDINANCES OF THE TOWN OF PARADISE VALLEY, DRAINAGE EASEMENTS ARE FOR THE PURPOSE OF ALLOWING STORM, FLOOD AND OTHER WATERS TO PASS OVER, UNDER, OR THROUGH THE LAND SET ASIDE FOR SUCH EASEMENTS, AND NOTHING WHICH MAY, TO ANY DEGREE, IMPEDE OR OBSTRUCT THE FLOW OF SUCH WATER, SHALL BE CONSTRUCTED, PLACED, PLANTED OR ALLOWED TO GROW ON OR IN SUCH EASEMENTS. THE MAINTENANCE AND CLEARING OF THESE DRAINAGE EASEMENTS SHALL BE THE SOLE RESPONSIBILITY AND DUTY OF THE OWNER OF THE PROPERTY ON WHICH SAID EASEMENTS ARE PLATTED. HOWEVER, IF THE TOWN DEEMS IT TO BE IN THE BEST INTERESTS OF THE HEALTH, SAFETY, OR WELFARE OF THE TOWN OF PARADISE VALLEY, THE TOWN OF PARADISE VALLEY MAY CONSTRUCT AND/OR MAINTAIN DRAINAGE FACILITIES ON OR UNDER SUCH EASEMENTS. AGENTS AND EMPLOYEES OF THE TOWN OF PARADISE VALLEY SHALL HAVE FREE ACCESS TO AND FROM ALL PORTIONS OF SUCH EASEMENTS AT ALL TIMES.

100 YEAR ASSURED WATER SUPPLY

THE AREA PLATTED HEREON LIES WITHIN THE DOMESTIC WATER SERVICE AREA OF EPCOR WATER ARIZONA INC. - PARADISE VALLEY WHICH IS DESIGNATED AS HAVING AN ASSURED WATER SUPPLY PURSUANT TO SECTION 45-576 ARIZONA REVISED STATUTES AS PER ARIZONA DEPARTMENT OF WATER RESOURCES CERTIFICATE NUMBER 27-700839.0000 DATED NOVEMBER 12, 2015.

BASIS OF BEARING

THE BASIS OF BEARING FOR THIS SURVEY IS NORTH 00°16'59" WEST ALONG THE WEST LINE OF THE SOUTHWEST QUARTER OF SECTION 9, TOWNSHIP 2 NORTH, RANGE 4 EAST OF THE GILA AND SALT RIVER MERIDIAN, MARICOPA COUNTY, ARIZONA.

BENCHMARK

WEST 1/4 CORNER OF SECTION 9, TOWNSHIP 2 NORTH, RANGE 4 EAST TOWN OF PARADISE VALLEY BRASS CAP IN HANDHOLE LOCATED AT THE INTERSECTION OF 56TH STREET & LINCOLN
ELEVATION = 1363.42 (NAVD 88)
MCDOT GDACS NO. 24534-1
N: 20751.98, E: 86642.68

UTILITY PROVIDERS

SEWER	CITY OF PHOENIX
WATER	EPCOR WATER
TELEPHONE	CENTURYLINK
CABLE	COX COMMUNICATIONS
GAS	SOUTHWEST GAS
ELECTRIC	ARIZONA PUBLIC SERVICE

SITE DATA

EXISTING ZONING	S.U.P. - RESORT
TOTAL UNITS	12

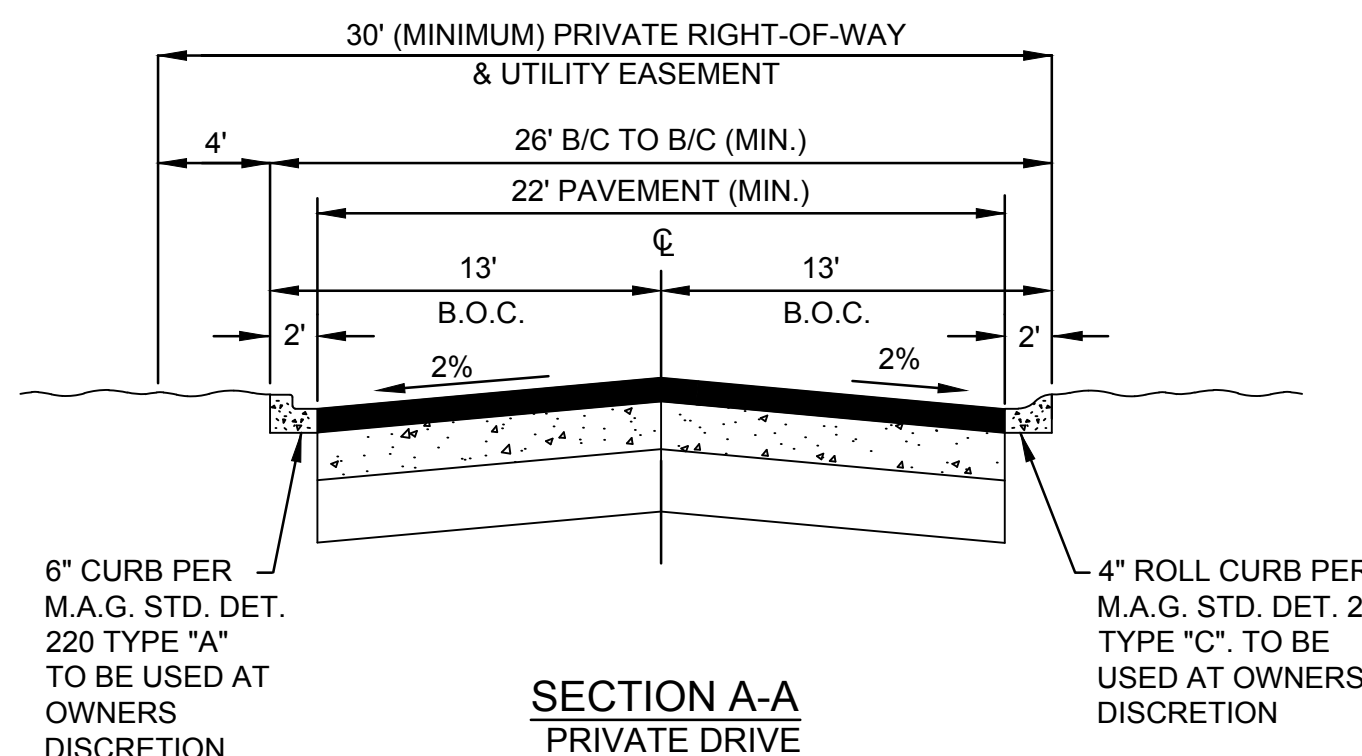

SECTION A-A
PRIVATE DRIVE

ALL PRIVATE DRIVES MAY BE CONSTRUCTED WITH INVERTED CROWN PAVEMENT AND/OR RIBBON CURB AT THE OWNER'S DISCRETION.

SHEET INDEX

- COVER SHEET, DEDICATION, NOTES
- BOUNDARY MAP
- FIRST LEVEL PLAN
- SECOND LEVEL PLAN
- UNIT PLANS & VERTICAL SCHEMATIC

NO.	REVISION	DATE

PRELIMINARY PLAT
THE VILLAS AT MOUNTAIN SHADOWS - AMENDED
PARADISE VALLEY, ARIZONA

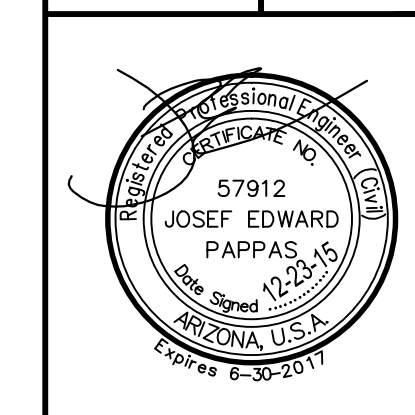

1 SHEET OF 5
CVL Contact: J. PAPPAS
CVL Project #: 01-0245801
CVL File #:

GROSS AREA = 1.008 ACRES

Print Date: December 23, 2015 File name: N:\010245801\CADD\WEST\Residential\NHR\1\Pre\plat_01.dwg

PRELIMINARY PLAT FOR "THE VILLAS AT MOUNTAIN SHADOWS - AMENDED - CONDOMINIUMS"

A CONDOMINIUM UPON TRACTS 'C' AND 'E' OF "THE VILLAS AT MOUNTAIN SHADOWS - AMENDED" AS RECORDED IN BOOK ____ OF MAPS, PAGE __, M.C.R. AND SITUATED IN THE SOUTHEAST QUARTER OF SECTION 8, TOWNSHIP 2 NORTH, RANGE 4 EAST, OF THE GILA AND SALT RIVER BASE AND MERIDIAN, MARICOPA COUNTY, ARIZONA

BOUNDARY MAP

COUNTY RECORDER

CVL
CONSULTANTS
4550 North 12th Street
Phoenix, Arizona 85014
602-264-6831
www.cvlci.com

CURVE TABLE						
NO.	ARC	RADIUS	DELTA	TANGENT	CHORD	CHORD-BEARING
C1	19.23	273.82	004°01'28"	9.62	19.23	N02°00'44"W

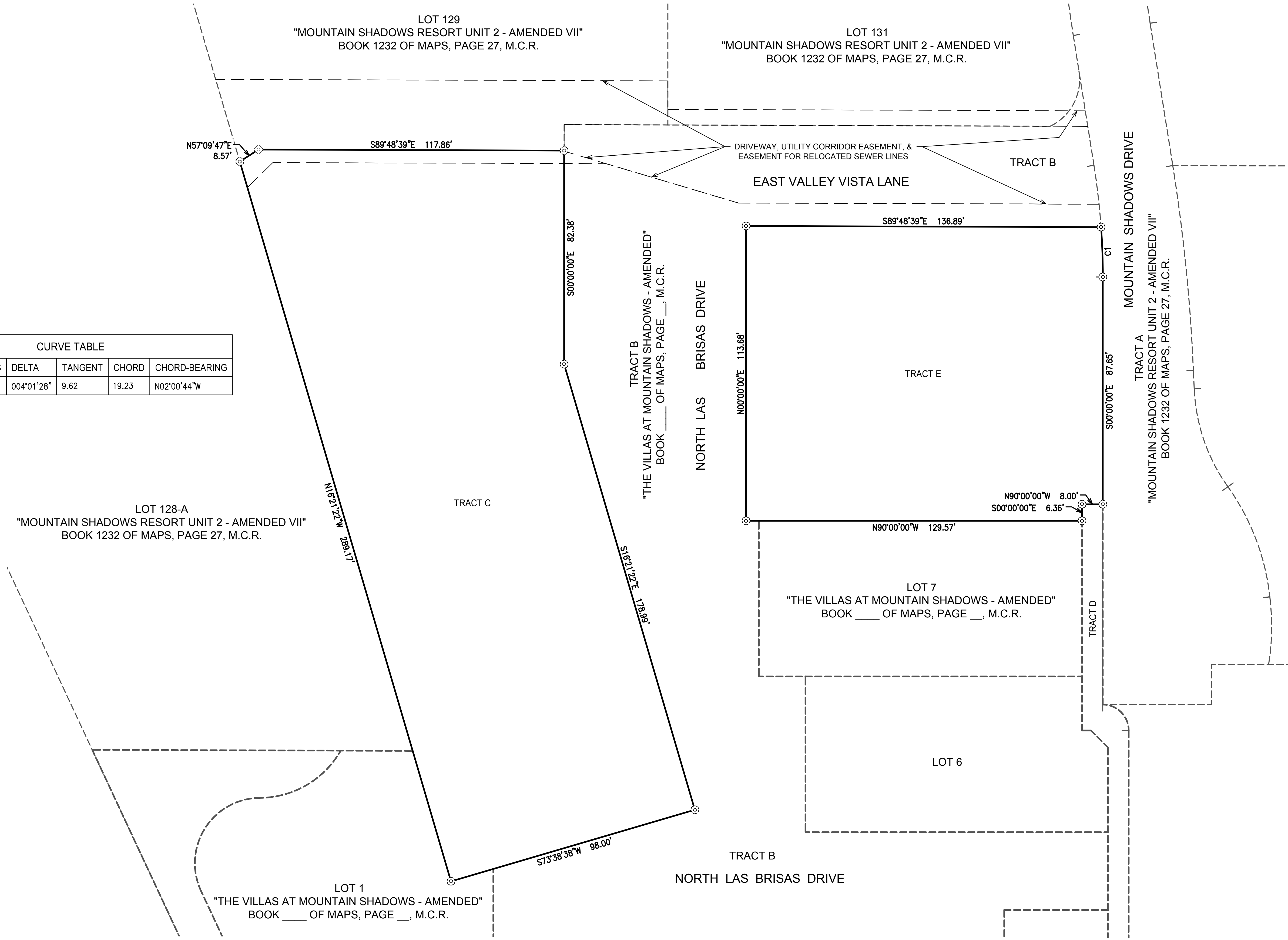

NO.	REVISION	DATE

Coe and Van Loo II L.L.C.

PRELIMINARY PLAT

THE VILLAS AT MOUNTAIN SHADOWS - AMENDED
PARADISE VALLEY, ARIZONA

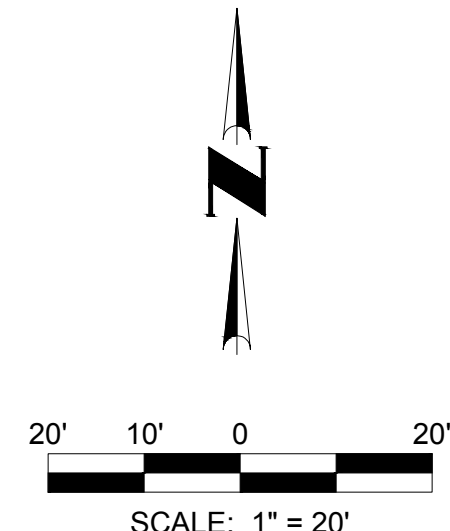
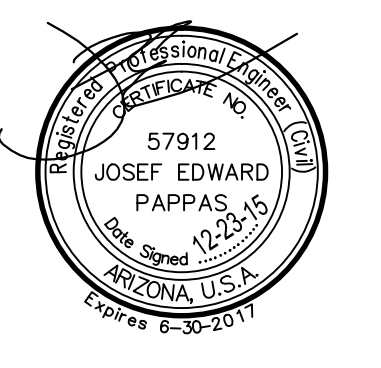

2 SHEET OF 5
CVL Contact: J. PAPPAS
CVL Project #: 01-0245801
CVL File #:

Printed By: Parker Print Date: December 23, 2015 File name: N:\010245801\CADD\WEST\Residential\NHR1\Pre\Plat.02.dwg

PRELIMINARY PLAT FOR "THE VILLAS AT MOUNTAIN SHADOWS - AMENDED - CONDOMINIUMS"

A CONDOMINIUM UPON TRACTS 'C' AND 'E' OF "THE VILLAS AT MOUNTAIN SHADOWS - AMENDED" AS RECORDED IN BOOK ____ OF MAPS, PAGE ___, M.C.R. AND SITUATED IN THE SOUTHEAST QUARTER OF SECTION 8, TOWNSHIP 2 NORTH, RANGE 4 EAST, OF THE GILA AND SALT RIVER BASE AND MERIDIAN, MARICOPA COUNTY, ARIZONA

FIRST LEVEL PLAN

COUNTY RECORDER

CVL
CONSULTANTS
4550 North 12th Street
Phoenix, Arizona 85014
602-264-6831
www.cvlci.com

CURVE TABLE						
NO.	ARC	RADIUS	DELTA	TANGENT	CHORD	CHORD-BEARING
C1	19.23	273.82	004°01'28"	9.62	19.23	N02°00'44"W

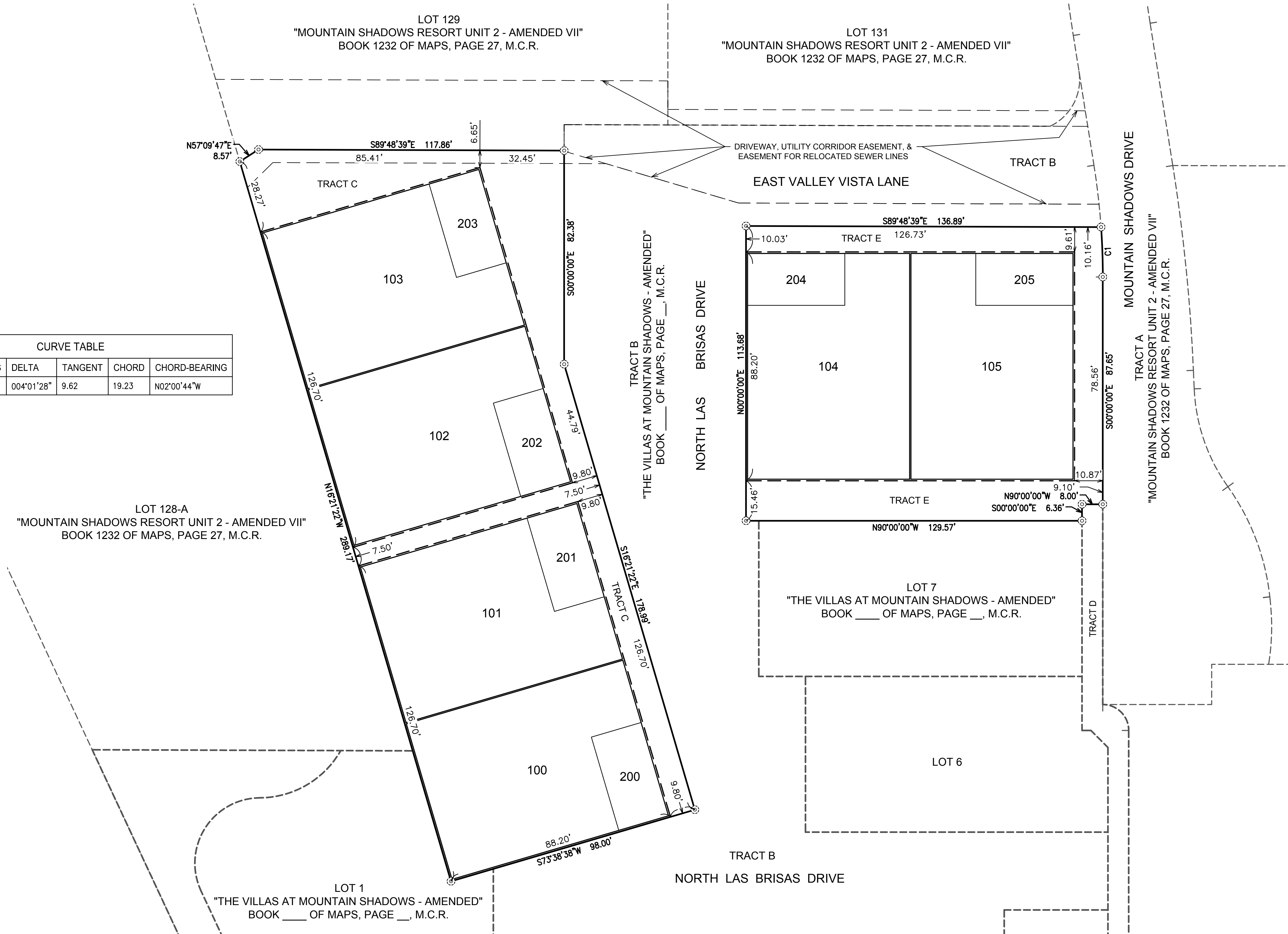

NO.	REVISION	DATE

PRELIMINARY PLAT
THE VILLAS AT MOUNTAIN SHADOWS - AMENDED
PARADISE VALLEY, ARIZONA

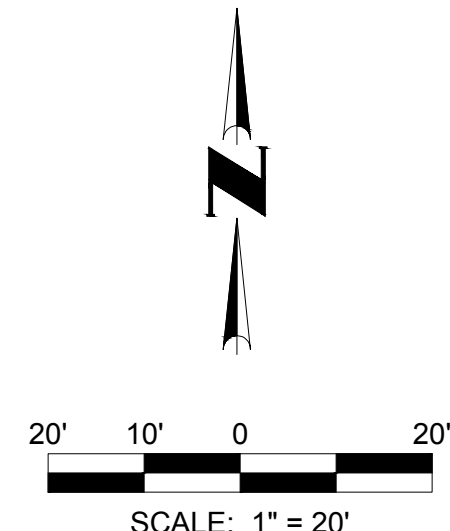
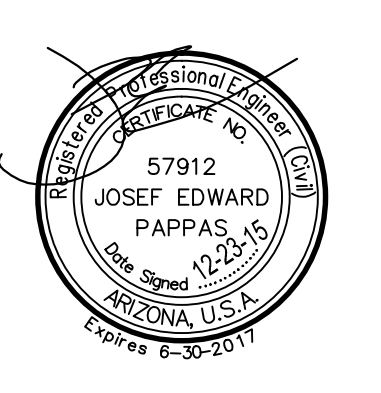

Printed By: Parker Print Date: December 23, 2015 File name: N:\010245801\CADD\WEST\Residential\NHR\1\Pre\plat\03.dwg

PRELIMINARY PLAT FOR "THE VILLAS AT MOUNTAIN SHADOWS - AMENDED - CONDOMINIUMS"

A CONDOMINIUM UPON TRACTS 'C' AND 'E' OF "THE VILLAS AT MOUNTAIN SHADOWS - AMENDED" AS RECORDED IN BOOK ____ OF MAPS, PAGE __, M.C.R. AND SITUATED IN THE SOUTHEAST QUARTER OF SECTION 8, TOWNSHIP 2 NORTH, RANGE 4 EAST, OF THE GILA AND SALT RIVER BASE AND MERIDIAN, MARICOPA COUNTY, ARIZONA

SECOND LEVEL PLAN

COUNTY RECORDER

CVL
CONSULTANTS
4550 North 12th Street
Phoenix, Arizona 85014
602-264-6831
www.cvlci.com

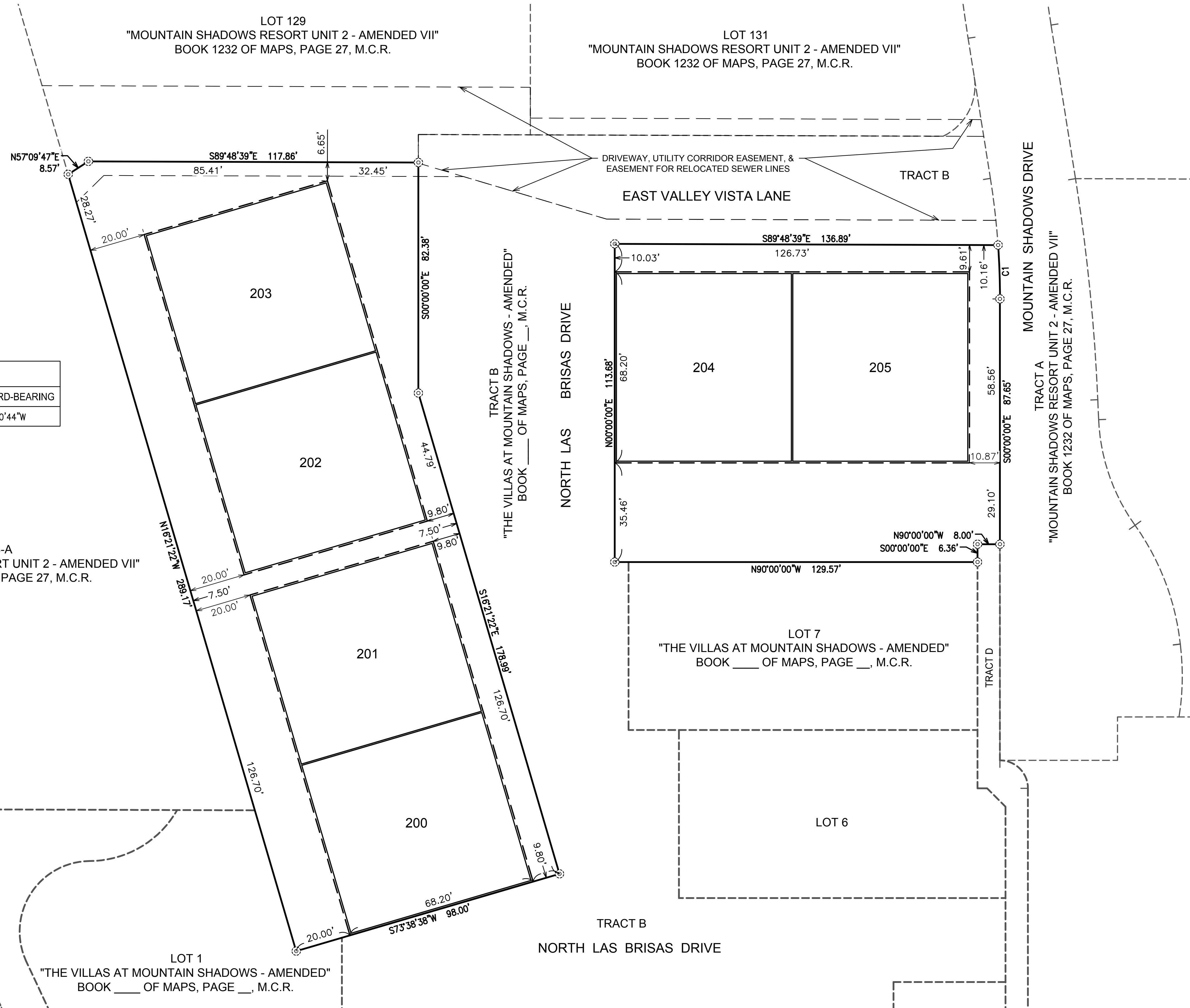

CURVE TABLE						
NO.	ARC	RADIUS	DELTA	TANGENT	CHORD	CHORD-BEARING
C1	19.23	273.82	004°01'28"	9.62	19.23	N02°00'44"W

NO.	REVISION	DATE

Coe and Van Loo II L.L.C.

PRELIMINARY PLAT

THE VILLAS AT MOUNTAIN SHADOWS - AMENDED
PARADISE VALLEY, ARIZONA

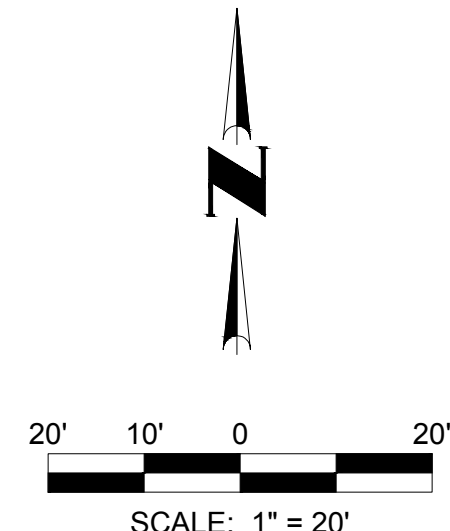
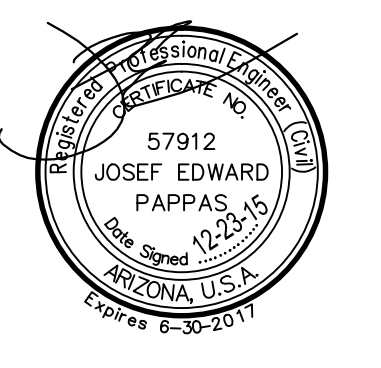

4 SHEET OF 5

CVL Contact: J. PAPPAS
CVL Project #: 01-0245801
CVL File #:

Printed By: Parker Print Date: December 23, 2015 Filename: N:\010245801\CADD\WEST\Residential\NHR\1\Pre\plat\04.dwg

PRELIMINARY PLAT FOR "THE VILLAS AT MOUNTAIN SHADOWS - AMENDED - CONDOMINIUMS"

A CONDOMINIUM UPON TRACTS 'C' AND 'E' OF "THE VILLAS AT MOUNTAIN SHADOWS - AMENDED" AS RECORDED IN BOOK ____ OF MAPS, PAGE __, M.C.R. AND SITUATED IN THE SOUTHEAST QUARTER OF SECTION 8, TOWNSHIP 2 NORTH, RANGE 4 EAST, OF THE GILA AND SALT RIVER BASE AND MERIDIAN, MARICOPA COUNTY, ARIZONA

COUNTY RECORDER

CVL
CONSULTANTS
4550 North 12th Street
Phoenix, Arizona 85014
602-264-6831
www.cvlci.com

UNIT PLANS & VERTICAL SCHEMATIC

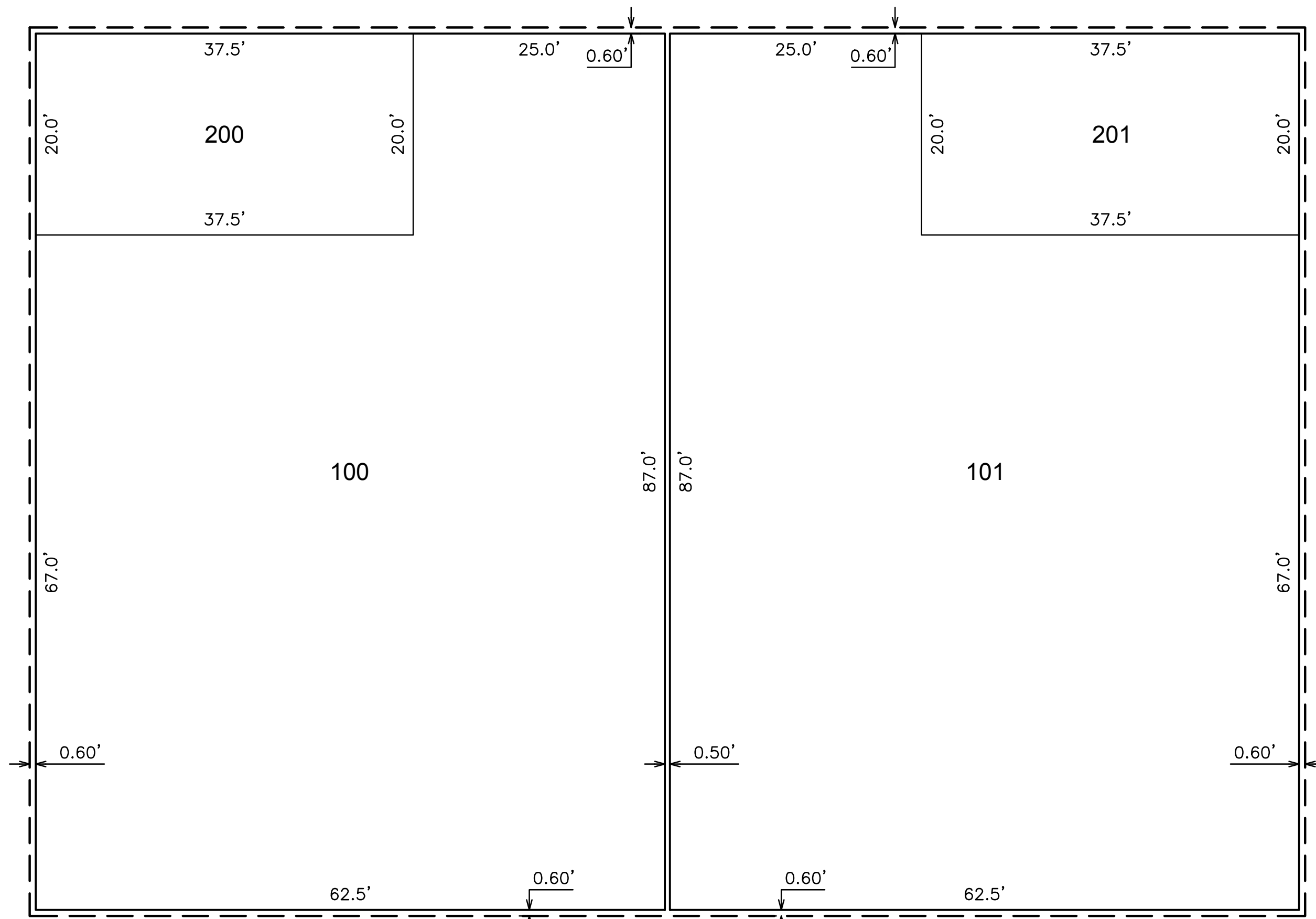

FIRST LEVEL PLAN
(SCALE: 1" = 10')

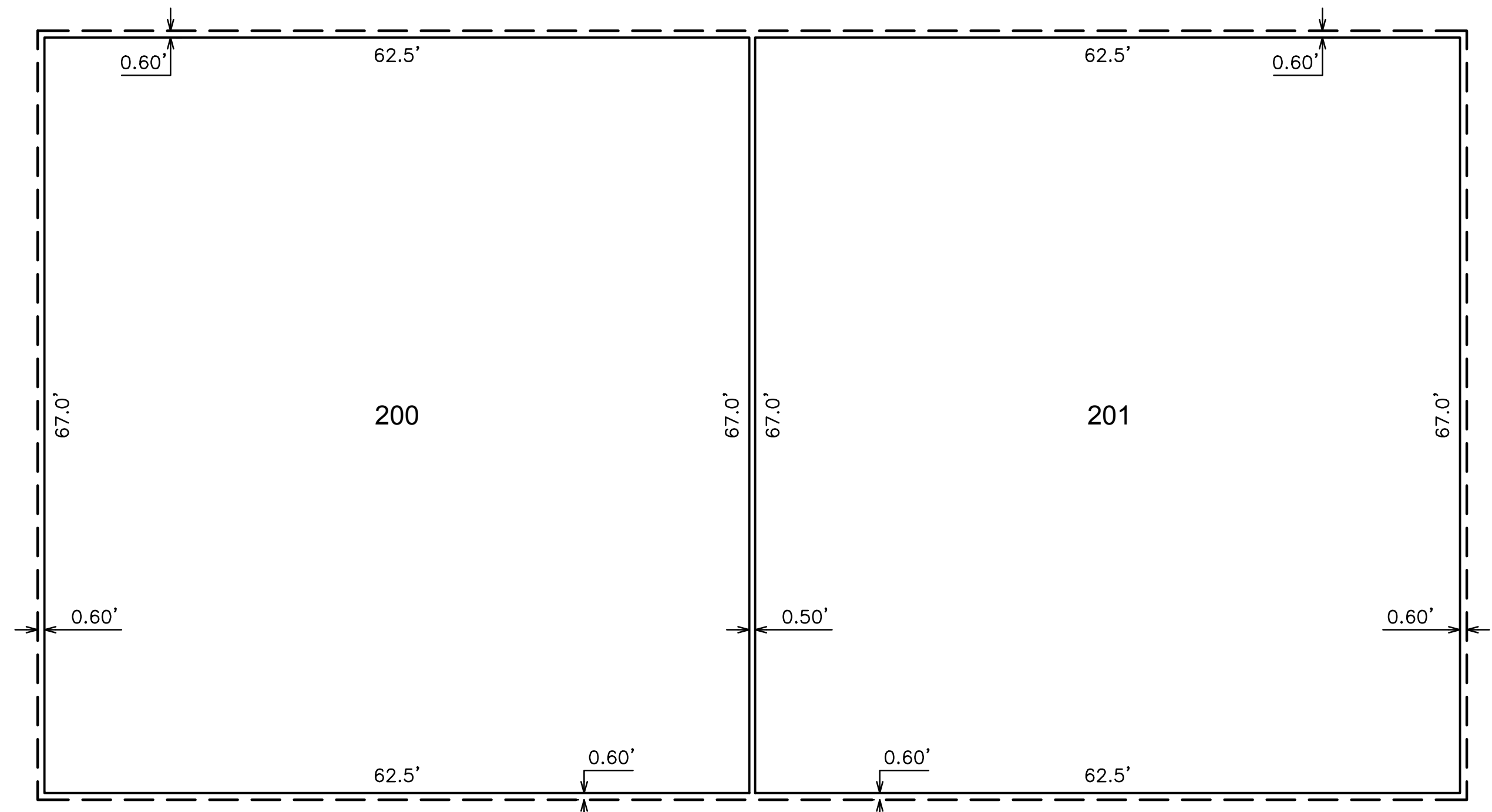

SECOND LEVEL PLAN
(SCALE: 1" = 10')

UNIT TYPE A - ELEVATION		
UNIT NO.	LOWER UNIT BOUNDARY	UPPER UNIT BOUNDARY
100		
101		
102		
103		
104		
105		

LEGEND

- INDICATES INTERIOR BOUNDARY
- - - - - INDICATES EXTERIOR FACE / COMMON WALL

UNIT TYPE B - ELEVATION		
UNIT NO.	LOWER UNIT BOUNDARY	UPPER UNIT BOUNDARY
200		
201		
202		
203		
204		
205		

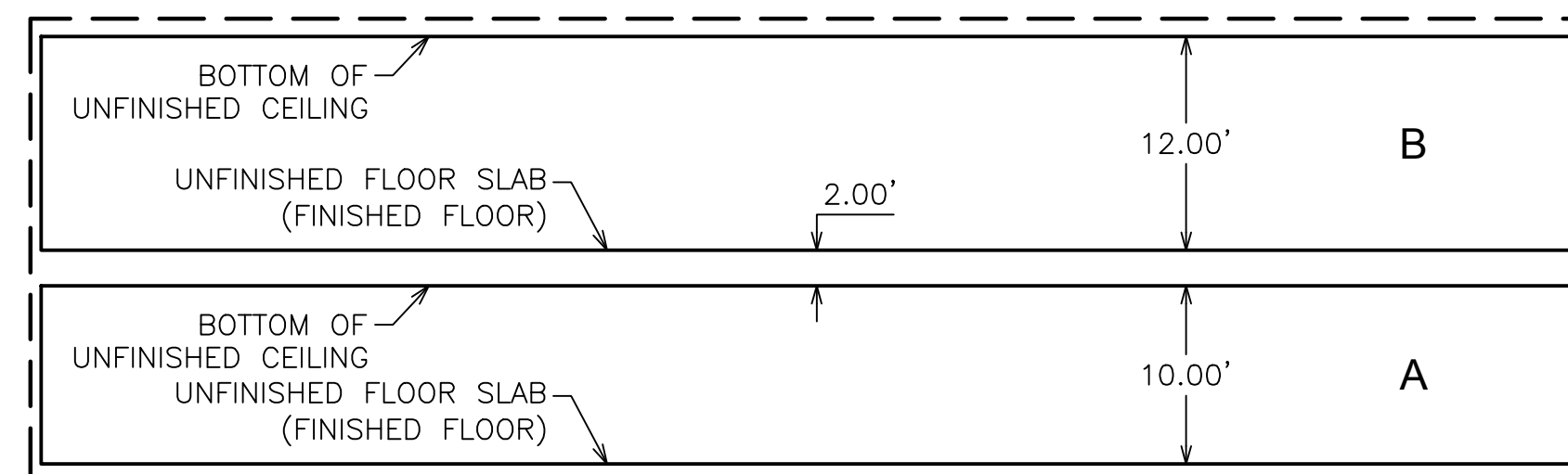

VERTICAL SCHEMATIC
(SCALE: 1" = 10')

NO.	REVISION	DATE

PRELIMINARY PLAT

**THE VILLAS AT MOUNTAIN SHADOWS - AMENDED
PARADISE VALLEY, ARIZONA**

Coe and Van Loo II L.L.C.

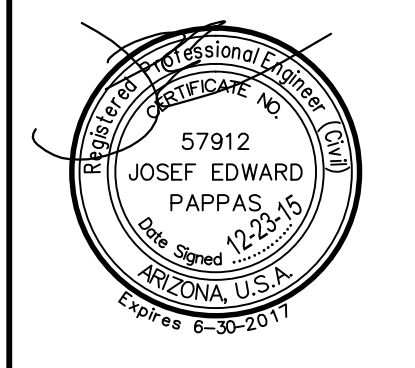

Printed By: Parker Print Date: December 23, 2015 File name: N:\010245801\CADD\WEST\Residential-NHR\1\Pre\plat\05.dwg