

# TOWN OF PARADISE VALLEY

Paradise Valley Medical Plaza  
Intermediate Special Use Permit Amendment  
Town Council  
Work Session  
SUP-18-10

May 9, 2019



# TODAY'S GOAL

---

- Review PV Medical Plaza Intermediate SUP Amendment for new:
  - Medical Building,
  - Parking,
  - Covered Parking Canopies,
  - Signage,
  - Landscaping, and
  - Screen Wall
  
- Review & Take Action on SUP 18-10 and Ordinance 2019-01



# AGENDA

- Background
- Scope of Request
- Recommendation & Action





# VICINITY MAP

Subject Property

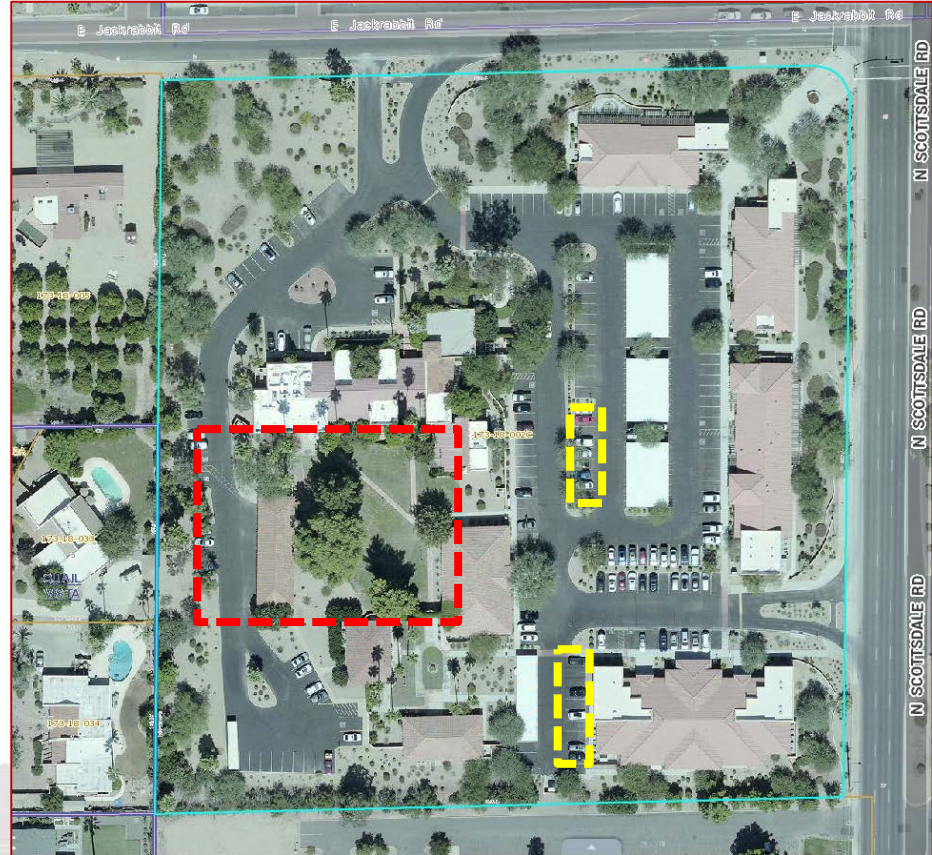
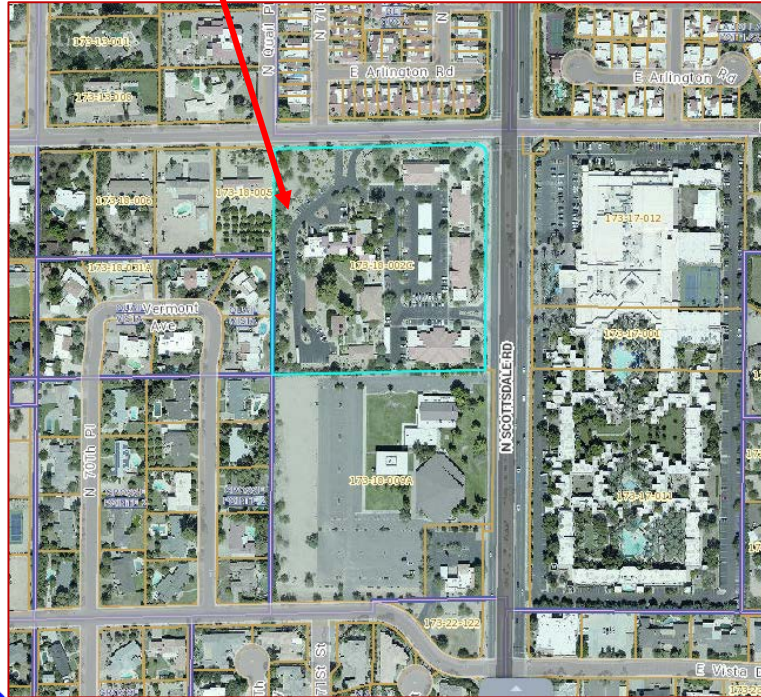

# HISTORY

---

- Special Use Permit (SUP):
  - Issued 1979
  - 2003 Amendment to add 5 Bldgs, New Parking, Signage, Landscaping & Lighting
- Statement of Direction (SOD):
  - TC Issued SOD on November 15, 2018



# BACKGROUND

---

- December 4<sup>th</sup> PC WS & December 18<sup>th</sup> PC PH:
  - Modified Ord. 2019-01 by removing reference to prior plans no longer in effect and approval for monument sign which included property address and name of medical plaza on top of sign
  - Forward Ordinance 2019-01 to TC with Recommendation of Approval by vote of 6 to 0



# BACKGROUND (CONT.)

---

- Town Council Review:
  - January 24<sup>th</sup> WS review and requested that applicant provide traffic study
  - March 14<sup>th</sup> - Council granted applicant request for continuance to May 9<sup>th</sup> to provide additional time to address neighborhood concerns











# MEDICAL BUILDING

## Site Plan

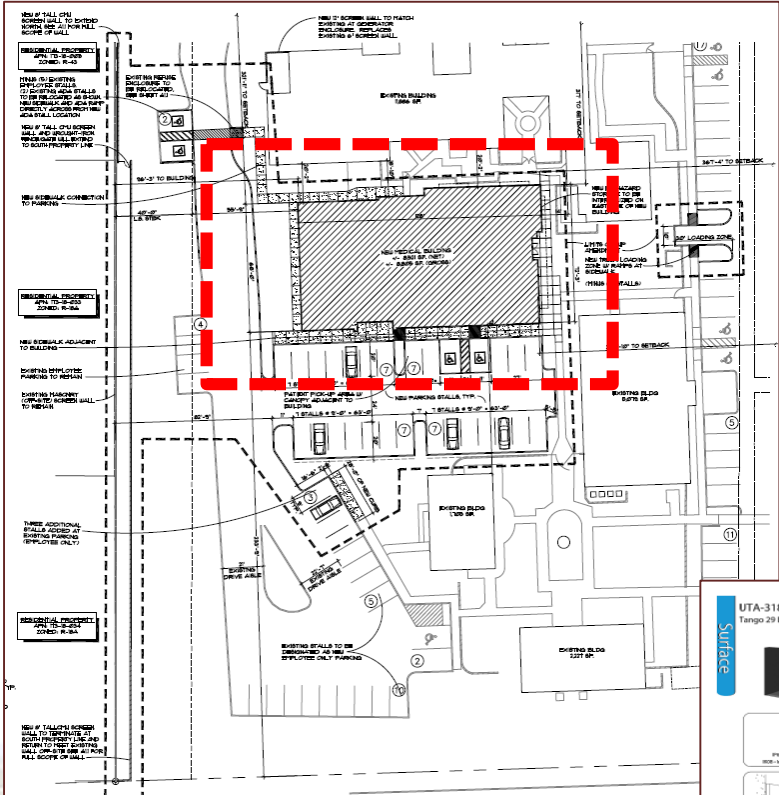

## Building Elevation

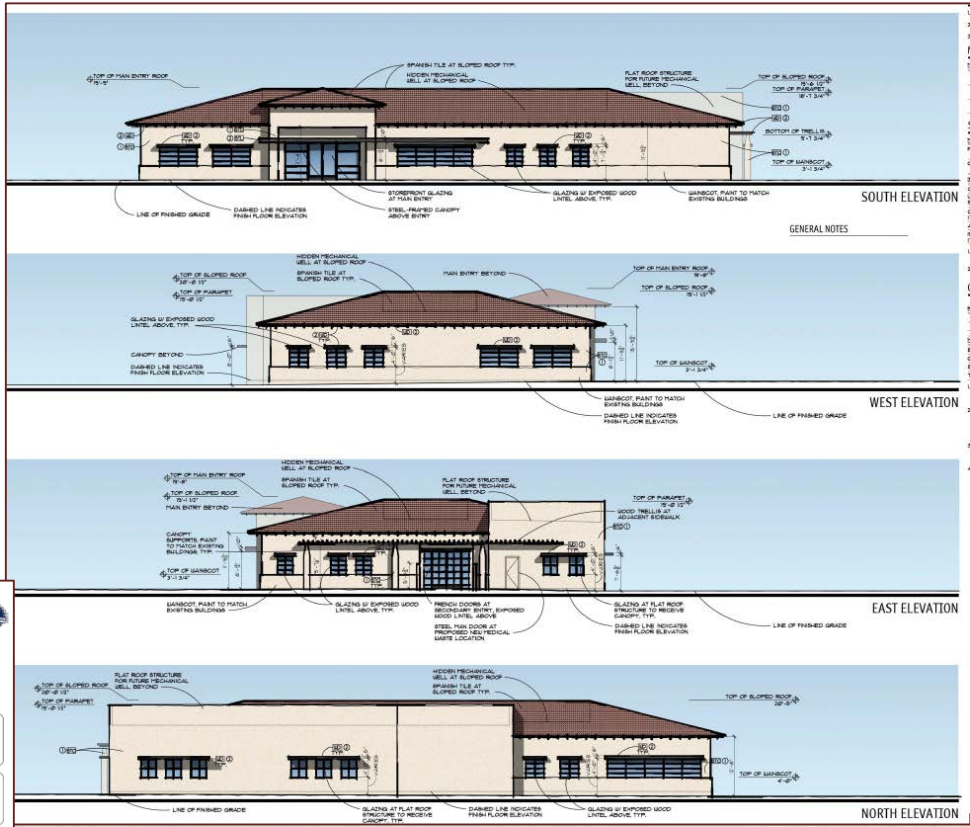

**UTA-31861**  
Tango 28 Downlight

**Surface**

**Physical Data**  
Length: 4.1"  
Height: 10.2"  
Weight: 4.8 lbs.  
Fits Inside for 700 Luminaire  
Not Impact Resistant or Thermal Protected

Type 1   Type 2   Type 3



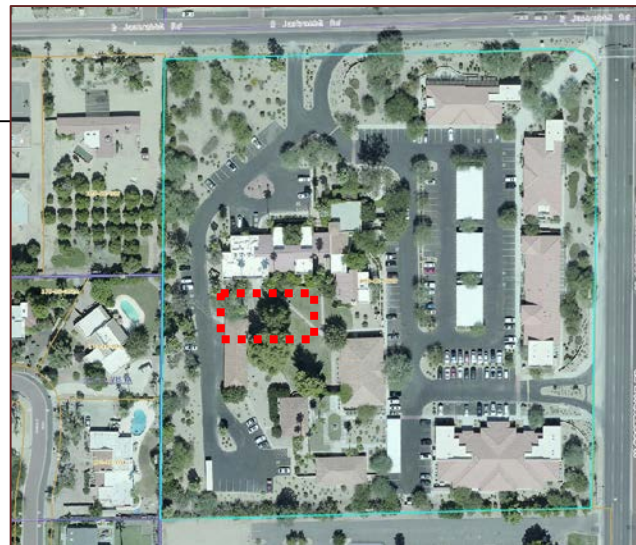

PHOTOS

May 9, 2019





# PARKING LOT LIGHTING

- 4 Pole Lights:
  - 8' tall
  - Match Existing Lights
  - 0-ft candles at p.l.

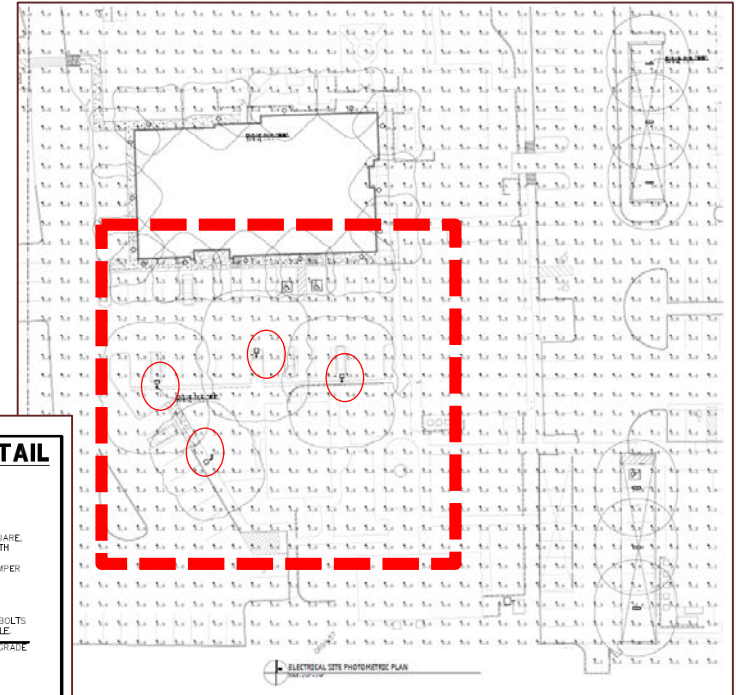
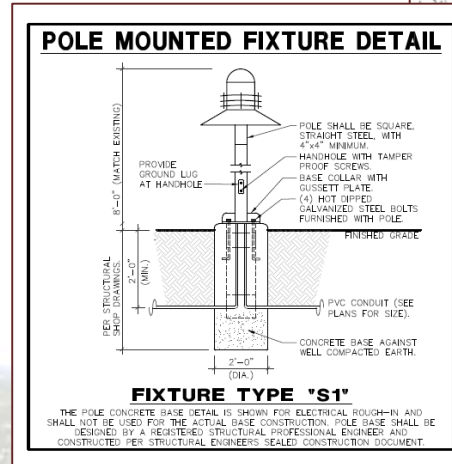
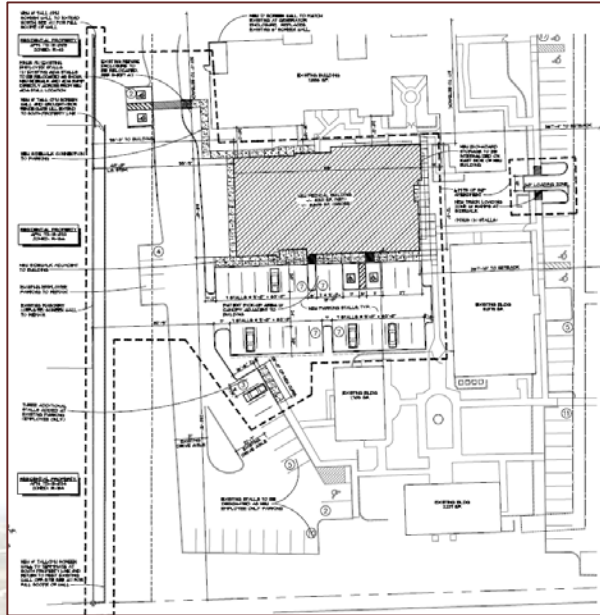

# PHOTOS







# PHOTOS





# NEW LANDSCAPING

- Placed around new building, parking area, and along west property line
- No new landscape lighting
- 33 new trees
- 312 new plants
- Palette:
  - Palo Verde Trees
  - Mesquite Trees
  - Willow Acacia Trees
  - Desert Spoon
  - Orange Jubilee

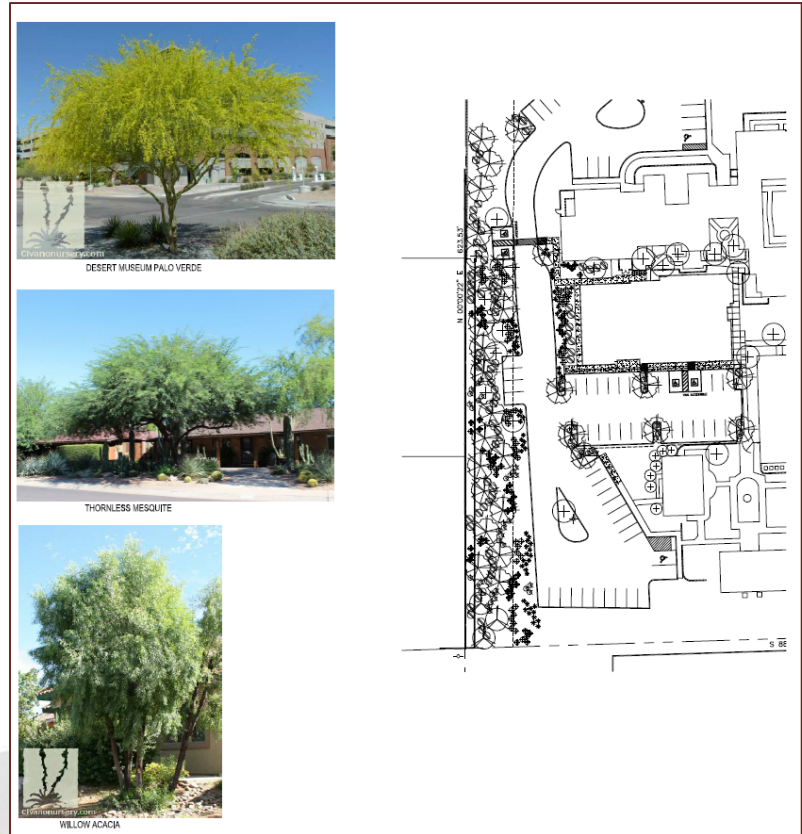

# SIGNAGE

- 5 New Types of Signage:
  - Monument Sign
  - Tenant/Directional Sign
  - Tenant ID Signs
  - Building Sign
  - No Delivery/Delivery Signs

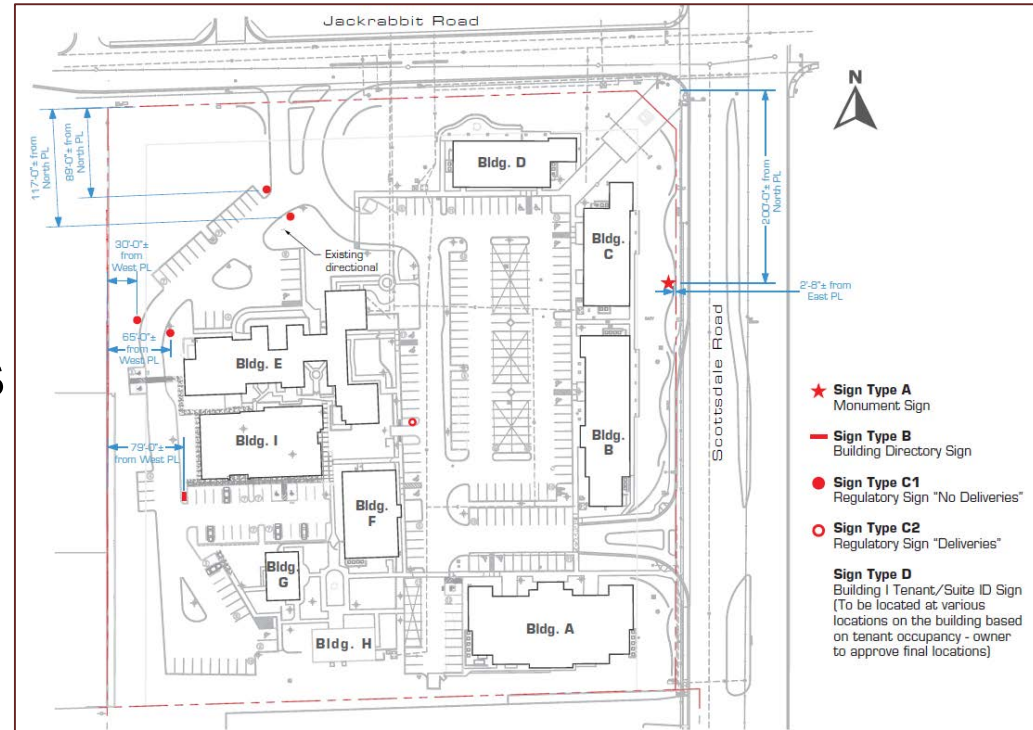

# NEW MONUMENT SIGN

- Placed next to Scottsdale Road, near Building C
- Double-faced sign
- 8' tall and 8'4" wide (67.2 sq ft total area per side & 40 sq ft of copy per side)
- Finished to match buildings on campus
- Non-illuminated
- Identify address, name of plaza, and name of tenants

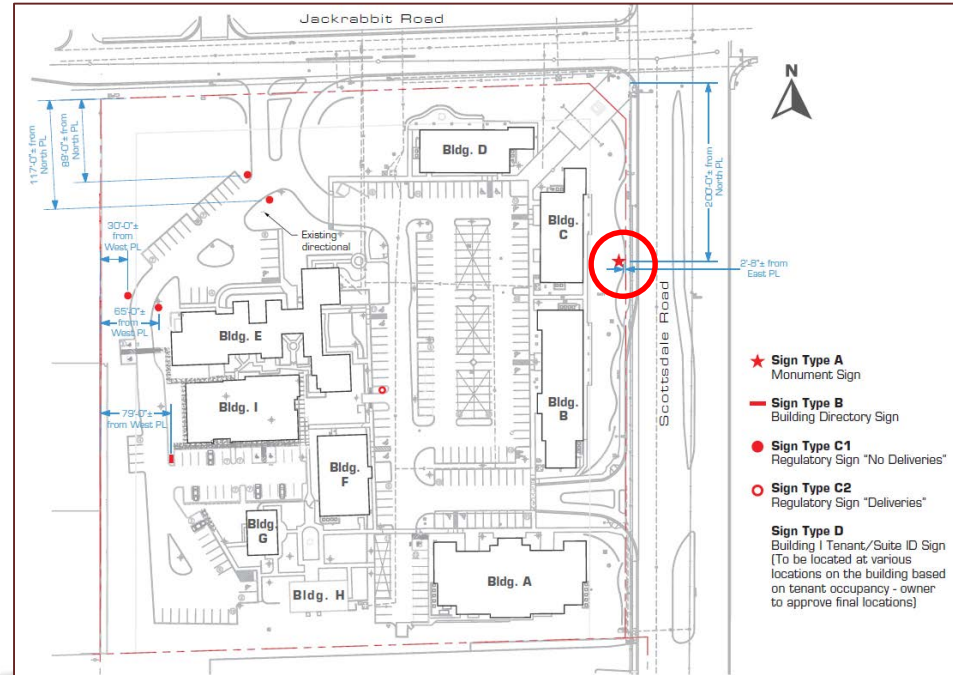

# MONUMENT SIGN (CONT.)

- Existing Signs:
  - 2 wall mounted signs at each entrance
  - Combined area of 42 sq ft
- SUP Guidelines Recommend:
  - 1 ground sign at each entrance
  - Max 8' tall and no larger than 40 sq ft at each entrance
- New monument sign not placed at entrance and *exceeds* 40 sq ft limit
- Sign not illuminated and screened from western properties by existing buildings
- Tenant Names (5 names each side)

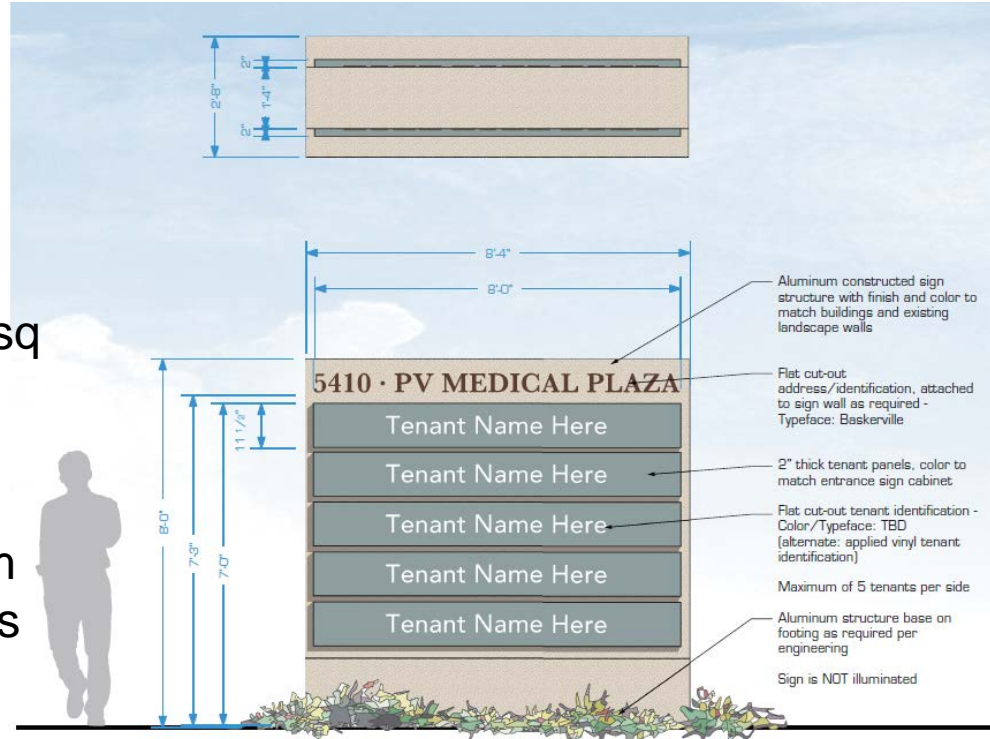



# MONUMENT SIGN (CONT.)



**Existing Conditions**



**Monument Sign Render**

# TENANT/DIRECTIONAL SIGNAGE

- Located between new medical building and new parking area
- Match existing directional signage on campus
- 5' tall and 4'6" wide (22.5 sq ft)
- Non-illuminated
- Identity tenant name and office/suite
- SUP Guidelines recommend 12 sq ft in and a 5' tall height
- Sign meets recommended height but exceeds the recommend size limit

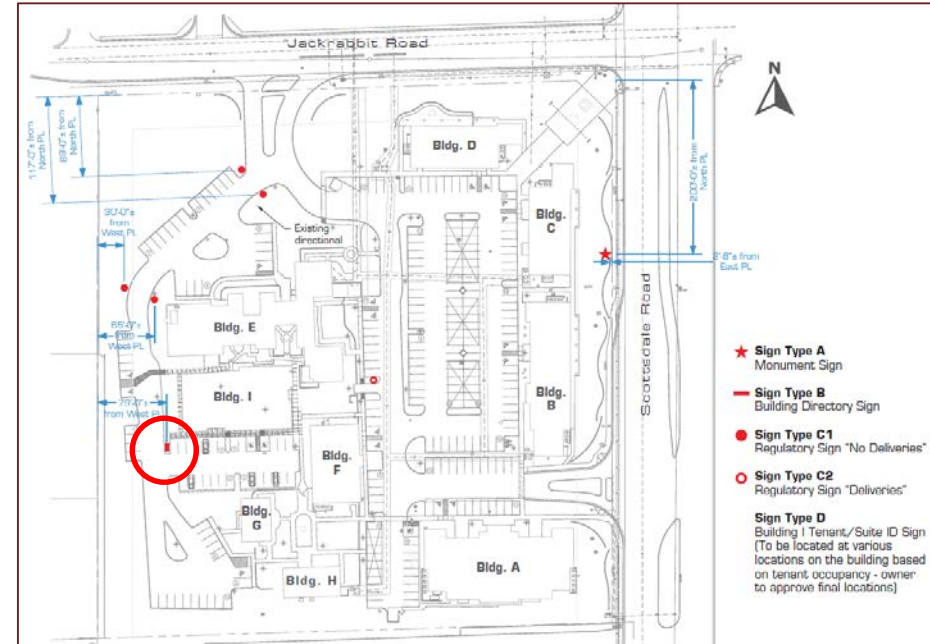

# TENANT/DIRECTIONAL SIGNAGE

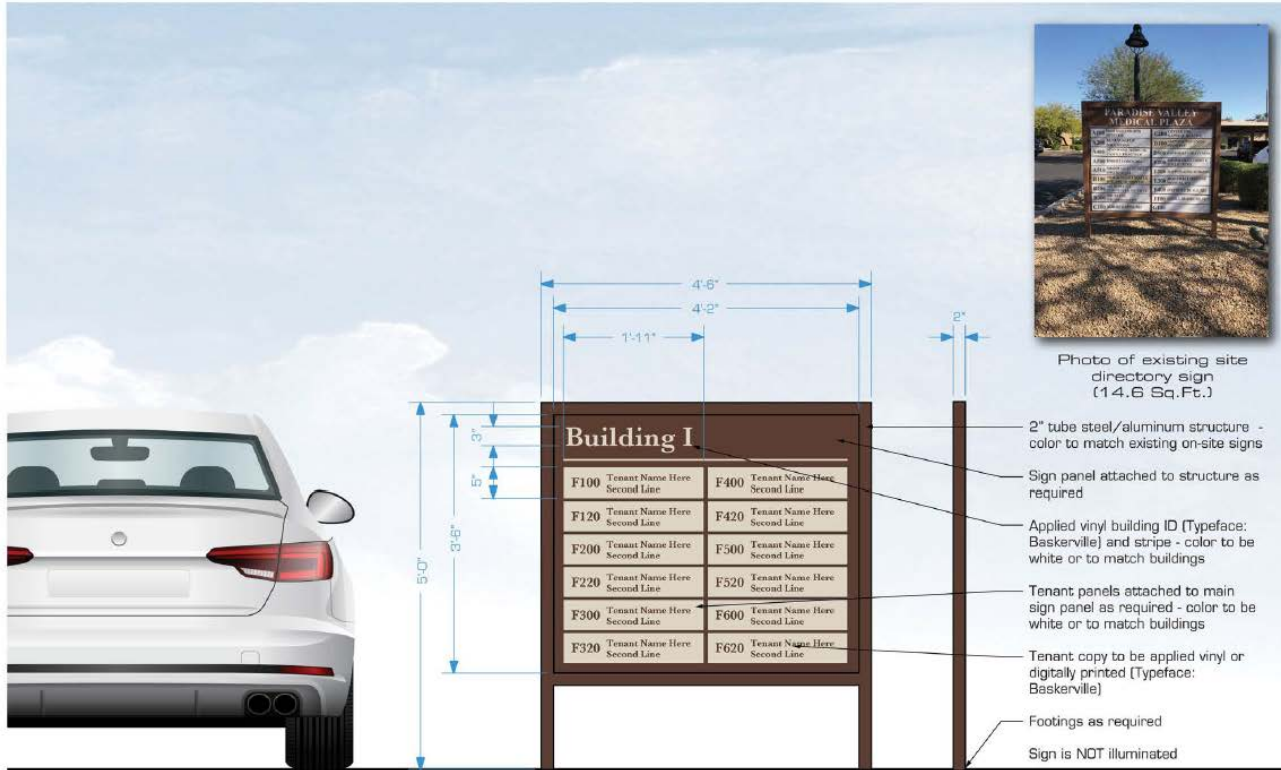

**Sign Type B - Building Directory Sign**

Scale: 3/4"=1'-0"

Qty: 1 - 14.6 Sq.Ft.





# TENANT I.D. SIGNAGE

- I.D. signs placed next to each office/suite
- Will match existing signs
- 1' tall and 2' wide (2 sq ft)
- Identify tenant name and suite number
- SUP Guidelines do not identify recommended size or height for tenant I.D. signs

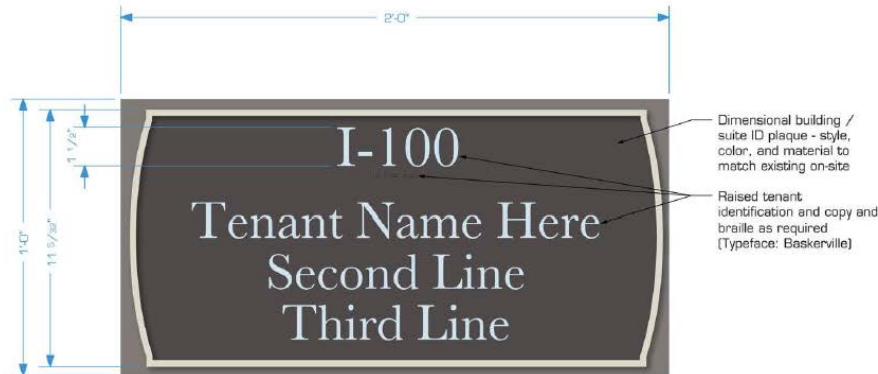

**Sign Type C - Building / Tenant/Suite ID Sign**

Scale: 3"=1'-0"

Qty: TBD - 2 Sq.Ft.



Photo of existing building / suite ID sign (2 Sq.Ft.)





# NO DELIVERIES SIGNS

- 4 “No Deliveries” signs
- Placed next to western drive aisle to discourage deliveries on west side of campus
- 5’ tall
- 2’ wide
- 4 sq ft
- Non-illuminated
- Compliant with SUP Guidelines (maximum 12 sq ft and 5’ height)

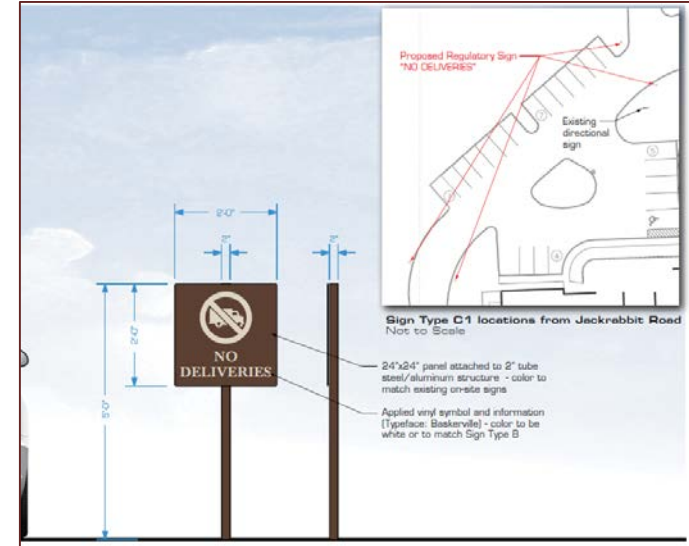



# DELIVERIES SIGN

- 1 “Deliveries” sign
- Placed at new truck loading area in center of campus
- 5’ tall
- 2’ wide
- 4 sq ft
- Compliant with SUP Guidelines (maximum 12 sq ft and 5’ height)

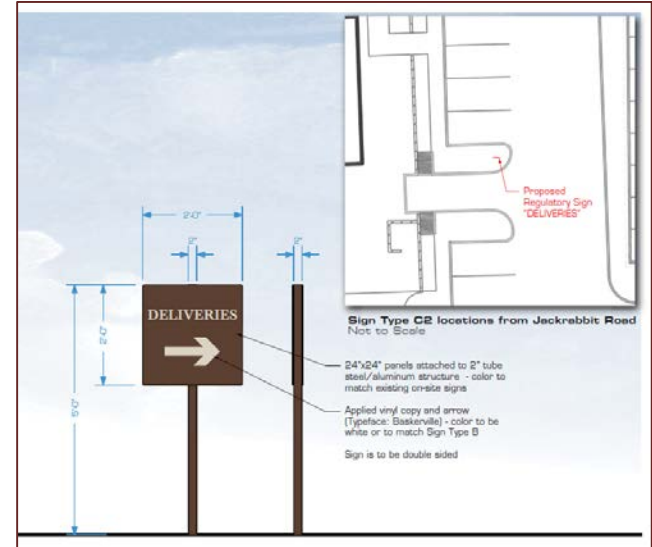
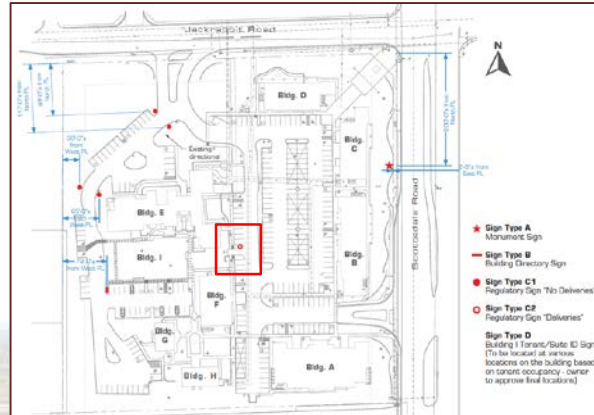



# PUBLIC COMMENT

- 2 Neighbors in Support:
  - First Southern Baptist Church
  - Northwest Neighbor
- Multiple Neighbors with Concerns or Opposition:
  - Noise
  - Traffic
  - Increased Intensity of Use
  - Garbage Pick-Up, etc.
- Copy of public comment and correspondence included in packet for TC review

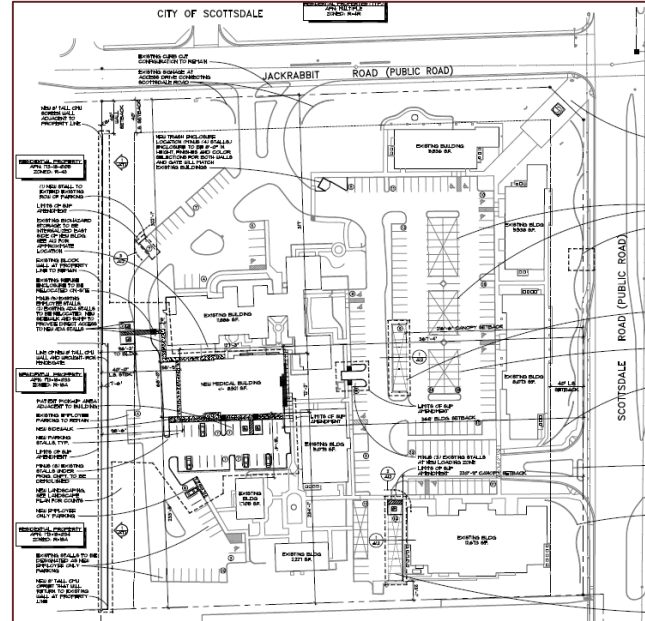





# INTERMEDIATE SUP AMENDMENT

---

- Intermediate SUP Amendment:
  - Since adding more than 5,000 sq ft, request constitutes an Intermediate Amendment
    - New Medical Building – 9,837 sq ft
    - New Parking Canopies – 3,359 sq ft



# RECOMMENDATION

---

- Approval of SUP-18-10 and Ordinance 2019-01:
  - Improvements match architecture of SUP
  - Improvements compliant with recommended setbacks, heights, and lot coverage
  - Monument sign located next to Scottsdale Rd and screened from west by existing bldgs
- Ordinance 2019-01 comprised of 16 Stipulations





# ORDINANCE 2019-01

---

1. All improvements shall be in substantial compliance with Narrative and Plans
2. Garbage pick-up shall be permitted only from 8 am – 5 pm.
3. In the event of a conflict between these Stipulations and the Approved Plans, these Stipulations shall govern.
4. The new monument sign, new building directory sign, new regulatory signs, new Building I tenant signs, and new Building I Suite I.D. signs shall not be illuminated.
5. No more than four operating rooms will be contained within the new building.



# ORDINANCE 2019-01 (CONT.)

---

6. The 8' tall screen wall as depicted on Sheet A1.1 and Sheet A1.2 may be: 1) constructed in accordance with the approved plans, or 2) constructed on the west property line for portions of the wall for which the Medical Plaza Owner has received written permission of the neighboring property owner.
7. Regarding the 8' tall screen wall as depicted on Sheet A1.1 and Sheet A1.2, the Medical Plaza Owner's side of the wall shall be either split face or integral color block or shall have a finish of stucco and paint, as determined by the Medical Plaza Owner. Each neighbor's side of the wall shall be finished with stucco and paint unless the Medical Plaza Owner and the neighbor agree otherwise.
8. The 8' tall screen wall as depicted on Sheet A1.1 and Sheet A1.2 shall be installed and receive all approved final inspections by the Town prior to the issuance of the Certificate of Occupancy on the new medical building.

# ORDINANCE 2019-01 (CONT.)

---

9. The landscaping along the west side of the campus, located between the west property line and the existing drive aisle, shall be installed in accordance with Sheet La.01 prior to start of construction on the medical building.
10. If requested in writing by the neighboring property owners, the Medical Plaza Owner will plant up to four 24” box trees in the yards of each of the three adjacent neighboring properties (APN: 173-18-034, APN: 173-18-033, and APN: 173-18-002C) within one year after start of construction.
11. All improvements shall comply with the applicable Town Grading & Drainage codes and requirements.
12. All mechanical equipment shall be screened so that it is not visible from properties not a part of this Special Use Permit and from public rights-of-way. Mechanical equipment and mechanical equipment screens shall be included in the total height of any structure they are attached to.

## ORDINANCE 2019-01 (CONT.)

---

13. The Medical Plaza Owner shall install a speed bump across the drive aisle on the west side of the Property in a location north of the neighboring property APN: 173-18-033.
14. The Medical Plaza Owner shall pay up to \$10,000 for a speed bump on Vista Drive at a location to be determined by the Town. Alternatively, and if a speed bump is not acceptable to the affected neighbors, other traffic calming measures may be used in lieu of a speed bump.
15. The Medical Plaza Owner and Town shall sign and record a Waiver of Rights and Remedies agreement under A.R.S. § 12-1134 (Proposition 207 Waiver) in the form provided by the Town Attorney within 10 calendar days of the approval of this amendment to the Special Use Permit.
16. All existing Special Use Permit stipulations shall remain in full force and effect, unless changed or modified by the Intermediate Amendment SUP 18-10. May 9, 2019



# TODAY'S GOAL

- Review & Take Action on SUP 18-10 and Ordinance 2019-01

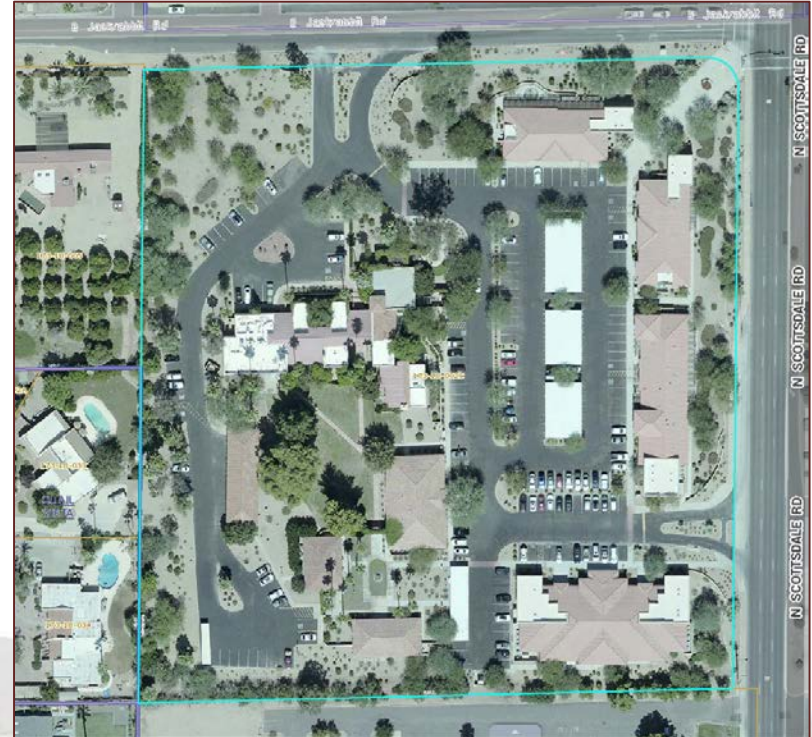
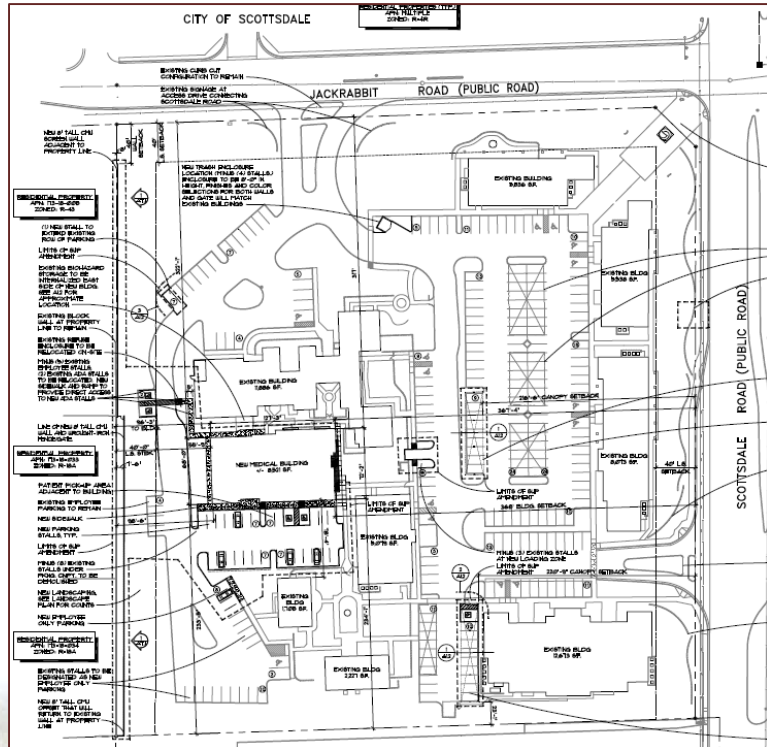



# STATEMENT OF DIRECTION (SOD)

- PC shall focus review on visible, audible, and operational effects amendment may have on neighbors. In particular, PC shall focus their review on:
  1. **Use.** Current use is medical office and this use will not change. However, one additional surgical facility will be added to the center. The PC shall evaluate if additional changes or measures are needed to mitigate any adverse effects created by the patient drop-off area and/or the increased intensity of use.
  2. **Traffic, Parking, and Circulation.** Existing ingress/egress points and drive aisles will remain and 33 new parking spaces will be added to accommodate new medical building. Attention shall be given to parking lot location, number of parking spaces, and dimension of parking spaces. The PC shall evaluate the parking analysis to determine if total number of provided parking spaces will accommodate improvements.



## SOD (CONT.)

---

3. **Signage.** PC shall evaluate any proposed signage associated with these improvements. Attention shall be paid to building mounted signage, directional signage, and resulting impact to neighbors including the location, dimensions, and illumination of any new signs.
  
4. **Impact to Adjacent Properties.** PC shall consider how proposed setbacks, heights, location of uses, and any other related design aspect (including, but not limited to noise and lighting) of improvements that may negatively impact nearby properties.
  - PC may request clarification and/or expansion of SOD based on additional information that has evolved
  
  - PC shall complete their review by **February 14, 2019**